

**Unconstrained Feasibility Study
NI 43-101 Technical Report on the Camino Rojo Gold Project
Municipality of Mazapil, Zacatecas, Mexico**

Prepared for:



202 – 595 Howe Street
Vancouver, BC, V6C 2T5
Canada



Prepared by:



Kappes, Cassiday & Associates
7950 Security Circle
Reno, NV 89506

Report Effective Date: 11 January 2021
Mineral Reserve Effective Date: 11 January 2021

Authors:

Carl Defilippi, Kappes, Cassiday & Associates, RM SME
Michael Hester, Independent Mining Consultants, Inc., FAusIMM
Dr. Matthew Gray, Resource Geosciences Incorporated, CPG
John Ward, Groundwater Consultant, CPG

CONTENTS

1.0	SUMMARY.....	1-1
1.1	Introduction and Overview	1-1
1.2	Property Description and Ownership	1-2
1.3	Geology & Mineralization.....	1-2
1.4	Exploration and Drilling.....	1-3
1.5	Metallurgical Test Work	1-4
1.6	Mineral Resource Estimate	1-6
1.7	Mineral Reserve Estimate	1-10
1.8	Mining Methods	1-13
1.9	Recovery Methods.....	1-13
1.10	Infrastructure	1-14
1.11	Environmental Studies, Permitting and Social or Community Impact.....	1-15
1.12	Capital and Operating Costs	1-19
1.13	Cautionary Statements	1-20
1.13.1	Forward Looking Information.....	1-20
1.13.2	Non-IFRS Measures.....	1-22
1.14	Economic Analysis	1-22
1.15	Interpretations and Conclusions	1-26
1.15.1	Conclusions.....	1-26
1.15.2	Opportunities	1-26
1.15.3	Risks.....	1-27
1.15.3.1	Mining	1-27
1.15.3.2	Metallurgy and Process.....	1-28
1.15.3.3	Access, Title and Permitting.....	1-28
1.15.3.4	Other Risks	1-30
1.16	Recommendations.....	1-31
1.16.1	KCA Recommendations	1-31
1.16.2	RGI Recommendations	1-31
1.16.3	John Ward, CPG, Groundwater Consultant Recommendations	1-32
2.0	INTRODUCTION.....	2-1
2.1	Introduction and Overview	2-1
2.2	Project Scope and Terms of Reference	2-1
2.2.1	Scope of Work.....	2-1
2.2.2	Terms of Reference.....	2-3
2.3	Sources of Information	2-4
2.4	Qualified Persons and Site Visits	2-5
2.5	Frequently Used Acronyms, Abbreviations, Definitions and Units of Measure.....	2-7

3.0	RELIANCE ON OTHER EXPERTS	3-1
4.0	PROPERTY DESCRIPTION AND LOCATION	4-1
4.1	Area and Location	4-1
4.2	Claims and Title.....	4-2
4.2.1	Orla Control of Mining Concessions via Acquisition from Minera Peñasquito SA de CV.....	4-5
4.2.2	Orla’s Access to a Portion of Fresnillo’s Mining Concessions	4-6
4.2.3	Pending Concession Reductions	4-7
4.3	Surface Rights	4-7
4.4	Environmental Liability.....	4-10
4.5	Permits	4-11
4.6	Access, Title, Permit and Security Risks	4-13
4.6.1	Access Risks	4-13
4.6.2	Title Risks.....	4-13
4.6.3	Permit Risks	4-13
4.6.4	Security Risks.....	4-13
4.7	Royalties.....	4-13
5.0	ACCESSIBILITY, CLIMATE, LOCAL RESOURCES, AND PHYSIOGRAPHY	5-1
5.1	Accessibility	5-1
5.2	Physiography, Climate and Vegetation	5-2
5.3	Local Resources and Infrastructure.....	5-3
6.0	HISTORY	6-1
6.1	Prior Ownership.....	6-1
6.2	Prior Exploration	6-1
6.3	Historical Metallurgical Studies.....	6-4
6.4	Historical Resource Estimates.....	6-4
6.4.1	Canplats	6-4
6.4.2	Goldcorp.....	6-4
6.5	Prior Production.....	6-4
7.0	GEOLOGICAL SETTING AND MINERALIZATION	7-1
7.1	Sources of Information	7-1
7.2	Regional Geology	7-1
7.3	Local Geology.....	7-4
7.3.1	General Deposit Geology	7-4
7.3.2	Structural Setting.....	7-7
7.3.3	Mineralized Zones	7-7
7.3.4	Alteration	7-11

7.4	Oxidation	7-11
7.5	Conclusions	7-13
8.0	DEPOSIT TYPES.....	8-1
9.0	EXPLORATION	9-1
10.0	DRILLING	10-1
10.1	General.....	10-1
10.2	Canplats Drilling	10-2
10.3	Goldcorp Drilling.....	10-3
10.4	Orla Drilling.....	10-4
10.5	Sampling.....	10-5
10.5.1	Canplats and Goldcorp Sampling.....	10-5
10.5.2	Orla Sampling.....	10-6
10.6	Conclusions	10-6
10.6.1	IMC Conclusion	10-6
10.6.2	RGI Conclusion	10-6
11.0	SAMPLE PREPARATION, ANALYSES AND SECURITY.....	11-1
11.1	Sample Preparation.....	11-1
11.2	Analyses	11-1
11.3	QA/QC Programs	11-2
11.3.1	Canplats QA/QC Program.....	11-2
11.3.2	Goldcorp QA/QC Program	11-2
11.3.3	Orla QA/QC Program	11-4
11.4	Sample Security	11-6
11.4.1	Canplats and Goldcorp Sample Security	11-6
11.4.2	Orla Sample Security	11-6
12.0	DATA VERIFICATION.....	12-1
12.1	Resource Model Data.....	12-1
12.1.1	Canplats and Goldcorp Drill Data.....	12-1
12.1.1.1	Assay Data.....	12-1
12.1.1.2	Collar Locations.....	12-1
12.1.1.3	Canplats RC Data.....	12-2
12.1.2	Orla Drill Data.....	12-3
12.1.3	Historical Data Reviews	12-3
12.1.3.1	Canplats.....	12-3
12.1.3.2	Goldcorp.....	12-3
12.2	Metallurgical Test Data.....	12-4

12.3	Site Visits by Qualified Persons.....	12-4
13.0	MINERAL PROCESSING AND METALLURGICAL TESTING.....	13-1
13.1	Canplats (2009 & 2010).....	13-3
13.1.1	SGS Mineral Services (2009).....	13-3
13.1.1.1	SGS Mineral Services 2009 – Column Leach Tests.....	13-3
13.1.1.2	SGS Mineral Services 2009 – Bottle Roll Leach Tests.....	13-5
13.1.1.3	SGS Mineral Services 2009 – Flotation Tests	13-7
13.1.2	Kappes, Cassiday & Associates (2010)	13-8
13.1.2.1	Kappes, Cassiday & Associates (2010) – Head Analyses and Cyanide Shake Tests	13-8
13.1.2.2	Kappes, Cassiday & Associates (2010) – Column Leach Tests	13-11
13.2	Goldcorp (2012-2015)	13-12
13.2.1	Kappes, Cassiday & Associates (2012)	13-13
13.2.1.1	Kappes, Cassiday & Associates (2012) - Head Analyses.....	13-13
13.2.1.2	Kappes, Cassiday & Associates (2012) – Bottle Roll Leach Tests	13-15
13.2.1.3	Kappes, Cassiday & Associates (2012) – Column Leach Test Work	13-19
13.2.2	Blue Coast Research Metallurgy (2012-2013)	13-21
13.2.3	Hazen Research (2014)	13-22
13.2.4	Comminution Testing	13-22
13.2.5	Kappes, Cassiday & Associates (2014 & 2015).....	13-23
13.2.5.1	Kappes, Cassiday & Associates (2015) – Head Analyses.....	13-26
13.2.5.2	Kappes, Cassiday & Associates (2014 & 2015) – Bottle Roll Leach Tests	13-29
13.2.5.3	Kappes, Cassiday & Associates (2015) – Column Leach Test Work	13-31
13.3	Orla (2019 & 2020)	13-32
13.3.1	Kappes, Cassiday & Associates (2019)	13-33
13.3.1.1	Kappes, Cassiday & Associates (2019) – Head Analyses & Physical Characterization	13-36
13.3.1.2	Kappes, Cassiday & Associates (2019) – Bottle Roll Leach Tests	13-40
13.3.1.3	Kappes, Cassiday & Associates (2019) – Agglomeration Test Work	13-41
13.3.1.4	Kappes, Cassiday & Associates (2019) – Column Leach Test Work	13-41
13.3.1.5	Kappes, Cassiday & Associates (2019) – Diagnostic Leach Test Work.....	13-46
13.3.2	Kappes, Cassiday & Associates (2020)	13-47
13.4	Conclusions from Metallurgical Programs	13-48
13.4.1	Crush Size and Recovery.....	13-50
13.4.2	Leach Cycle.....	13-53
13.4.3	Reagent Consumption Projection.....	13-53
13.4.3.1	Cyanide.....	13-53
13.4.3.2	Lime.....	13-54
13.5	Preg Robbing Discussion	13-54

13.6	Sulphide Mineralization Discussion	13-58
14.0	MINERAL RESOURCE ESTIMATES	14-1
14.1	Mineral Resource	14-1
14.1.1	Metal Prices for Mineral Resources	14-3
14.1.2	Cost and Recovery Estimates for Mineral Resources	14-3
14.1.3	Parameters for Mill Material	14-6
14.1.4	Additional Information.....	14-7
14.2	Description of the Block Model	14-10
14.2.1	General.....	14-10
14.2.2	Geological Controls	14-10
14.2.3	Potentially Contaminated RC Samples	14-20
14.2.4	Cap Grades and Compositing	14-20
14.2.5	Variograms	14-27
14.2.5.1	Northeast Domain.....	14-27
14.2.5.2	Southwest Domain.....	14-27
14.2.6	Block Grade Estimation.....	14-33
14.2.7	Resource Classification.....	14-38
14.2.8	Bulk Density	14-45
14.2.9	Mineral Resource Reconciliation.....	14-46
14.2.9.1	Leach Material.....	14-46
14.2.9.2	Mill Material.....	14-47
14.2.9.3	Total Leach Plus Mill Material.....	14-47
15.0	MINERAL RESERVE ESTIMATE	15-1
15.1	Mineral Reserve	15-1
15.2	Economic Parameters	15-3
16.0	MINING METHODS	16-1
16.1	Operating Parameters and Criteria.....	16-1
16.2	Slope Angles	16-1
16.3	Final Pit Design	16-4
16.4	Mine Production Schedule.....	16-8
16.5	Waste Storage Area and Stockpile.....	16-13
16.6	Mining Equipment.....	16-28
17.0	RECOVERY METHODS	17-1
17.1	Process Design Basis.....	17-1
17.2	Process Summary	17-2
17.3	Crushing	17-6
17.4	Reclamation and Conveyor Stacking	17-7

17.5	Leach Pad Design	17-8
17.6	Solution Application & Storage	17-12
17.7	Process Water Balance	17-16
17.7.1	Precipitation Data	17-16
17.7.2	Water Balance	17-18
17.8	Merrill-Crowe Recovery Plant	17-22
17.8.1	Refinery	17-25
17.8.2	Process Reagents and Consumables	17-26
17.8.2.1	Lime	17-27
17.8.2.2	Sodium Cyanide	17-27
17.8.2.3	Caustic	17-28
17.8.2.4	Zinc	17-28
17.8.2.5	Lead Nitrate	17-28
17.8.2.6	Diatomaceous Earth	17-28
17.8.2.7	Antiscalant	17-28
17.8.2.8	Fluxes	17-29
18.0	PROJECT INFRASTRUCTURE	18-1
18.1	Infrastructure	18-1
18.1.1	Existing Installations	18-1
18.1.2	Site Roads	18-1
18.1.3	Mine Haulage Road	18-1
18.1.4	Project Buildings	18-2
18.1.5	Administrative Offices	18-2
18.1.6	Mine Camp Facilities	18-2
18.1.7	Merrill-Crowe Process Facility	18-3
18.1.8	Refinery	18-4
18.1.9	Laboratory	18-4
18.1.10	Process Maintenance Workshop	18-4
18.1.11	Reagent Storage	18-4
18.1.12	Mine Truck Shop	18-5
18.1.13	Light Duty Truck Shop	18-5
18.1.14	Fuel Storage and Dispensing	18-5
18.1.15	Warehouse and Fenced Laydown Yard	18-5
18.1.16	Magazine Site	18-6
18.1.17	Guard Shack and Security	18-6
18.1.18	Medical Clinic	18-6
18.1.19	Fenced Areas	18-7
18.1.20	Airstrip	18-7
18.2	Power Supply, Communication Systems & IT	18-7

18.2.1	Power Supply	18-7
18.2.2	Site Distribution	18-7
18.2.3	Estimated Electric Power Consumption	18-8
18.2.4	Emergency Power	18-8
18.2.5	Communications.....	18-9
18.3	Water	18-9
18.3.1	Water Supply.....	18-9
18.3.2	Potable and Domestic Water.....	18-10
18.3.3	Fire Water and Protection	18-10
18.3.4	Surface Water Management	18-10
18.4	Sewage.....	18-11
19.0	MARKET STUDIES AND CONTRACTS.....	19-1
20.0	ENVIRONMENTAL STUDIES, PERMITTING AND SOCIAL OR COMMUNITY IMPACT	
	20-1	
20.1	Environmental Studies.....	20-1
20.1.1	Project Area Description.....	20-1
20.1.1.1	Climate	20-1
20.1.1.2	Soils	20-1
20.1.1.3	Hydrology	20-1
20.1.1.4	Physiography.....	20-2
20.1.1.5	Seismicity	20-2
20.1.1.6	Vegetation.....	20-2
20.1.1.7	Fauna.....	20-3
20.1.2	Environmental Management Plans	20-3
20.1.2.1	Surface Water Management.....	20-3
20.1.2.2	Ground Water Management.....	20-4
20.1.2.3	Air Quality Management.....	20-5
20.1.2.4	Flora and Wildlife Management	20-5
20.1.2.5	Soil Management Plan	20-5
20.1.2.6	Cyanide Management Plan	20-5
20.1.2.7	Waste Management Plan.....	20-5
20.1.2.8	Environmental Monitoring Program	20-6
20.1.3	Waste Handling	20-6
20.1.3.1	Hazardous Wastes.....	20-6
20.1.3.2	Non-hazardous Wastes	20-6
20.1.3.3	Putrescible (Domestic) Waste Disposal	20-6
20.1.3.4	Boneyard Storage.....	20-6

20.1.3.5	On-site BioRemediation Cell	20-7
20.1.3.6	Waste Water (Sewage) Disposal	20-7
20.1.4	Reclamation	20-7
20.1.4.1	Soil Handling	20-8
20.1.4.2	Camp	20-8
20.1.4.3	Central Operating Area	20-8
20.1.4.4	Mine Pit.....	20-9
20.1.4.5	Waste Rock Storage Facility (Mine Waste Dumps).....	20-10
20.1.4.6	Roads.....	20-12
20.1.5	Closure Activities – Heap Leach Facilities	20-14
20.1.5.1	Chemistry	20-14
20.1.5.2	Permanent Surface Water Diversion Works	20-15
20.1.5.3	Permanent Slope Stabilization	20-15
20.1.5.4	Final Engineering and Monitoring Plans	20-16
20.1.5.5	Heap Rinsing, Neutralization and Solution Management of HLP Seepage.....	20-16
20.1.5.6	Heap Slope Grooming and Slope Stabilization.....	20-17
20.1.5.7	Cover, Topsoil Placement and Revegetation of Heap and Surrounding Areas.....	20-17
20.1.5.8	Ponds and Pump Stations	20-17
20.1.5.9	Physical and Mobile Equipment.....	20-17
20.1.5.10	Roads, Diversion Works and Erosion Controls.....	20-18
20.1.5.11	Fencing.....	20-18
20.1.6	Post Closure Activities.....	20-18
20.1.6.1	Physical Monitoring and Maintenance	20-18
20.1.6.2	Geochemical Monitoring and Maintenance	20-18
20.1.6.3	Biological Monitoring and Maintenance.....	20-19
20.1.6.4	Surplus Water Management.....	20-19
20.1.7	Closure Cost Estimates – Heap Leach Facilities	20-20
20.2	Permitting	20-21
20.3	Social and Community Impact.....	20-27
20.3.1	Background	20-27
20.3.2	Population and Demographics	20-28
20.3.2.1	Indigenous Communities	20-28
20.3.2.2	Inhabitants, Age and Gender	20-28
20.3.2.3	Education	20-30
20.3.3	Infrastructure and Public Services.....	20-31
20.3.4	Government and Community	20-33
20.3.5	Economic Activity, Income, Marginalization	20-35
20.3.6	Social Management System and Mitigation of Negative Impacts	20-37

21.0 CAPITAL AND OPERATING COSTS	21-1
21.1 Capital Expenditures	21-2
21.1.1 Mining Capital Costs	21-4
21.1.1.1 Mining Contractor Mobilization and Demobilization	21-4
21.1.1.2 Mining Owner Equipment.....	21-4
21.1.1.3 Mine Development (Preproduction).....	21-5
21.1.2 Process and Infrastructure Capital Cost Estimate.....	21-6
21.1.2.1 Process and Infrastructure Capital Cost Basis.....	21-6
21.1.2.2 Major Earthworks and Liner.....	21-8
21.1.2.3 Civils	21-8
21.1.2.4 Structural Steel.....	21-8
21.1.2.5 Platework	21-8
21.1.2.6 Mechanical Equipment	21-8
21.1.2.7 Piping.....	21-9
21.1.2.8 Electrical.....	21-9
21.1.2.9 Instrumentation	21-10
21.1.2.10 Infrastructure & Buildings.....	21-10
21.1.2.11 Supplier Engineering and Installation Supervision / Commissioning.....	21-11
21.1.2.12 Process Mobile Equipment	21-11
21.1.2.13 Spare Parts	21-11
21.1.2.14 Process & Infrastructure Contingency	21-11
21.1.2.15 Process & Infrastructure Sustaining Capital.....	21-12
21.1.3 Construction Indirect Costs	21-12
21.1.4 Other Owner’s Construction Costs.....	21-13
21.1.5 Working Capital	21-13
21.1.6 Initial Fills Inventory.....	21-14
21.1.7 Engineering, Procurement & Construction Management	21-14
21.1.8 IVA.....	21-15
21.1.9 Exclusions	21-15
21.2 Operating Costs.....	21-15
21.2.1 Mining Operating Costs.....	21-16
21.2.1.1 Contract Mining Cost Basis	21-18
21.2.1.2 Blasting & Mine Technical Services Costs	21-18
21.2.2 Process and G&A Operating Costs.....	21-21
21.2.2.1 Personnel and Staffing	21-23
21.2.2.2 Power	21-23
21.2.2.3 Consumable Items.....	21-24
21.2.2.4 Heap Leach Consumables	21-24
21.2.2.5 Recovery Plant Consumables.....	21-24

21.2.2.6	Laboratory.....	21-25
21.2.2.7	Fuel.....	21-25
21.2.2.8	Miscellaneous Operating & Maintenance Supplies.....	21-25
21.2.2.9	Mobile / Support Equipment.....	21-25
21.2.2.10	G&A Expenses.....	21-26
21.3	Reclamation & Closure Costs.....	21-1
22.0	ECONOMIC ANALYSIS	22-2
22.1	Summary	22-2
22.2	Methodology	22-5
22.2.1	General Assumptions	22-6
22.3	Capital Expenditures	22-7
22.4	Metal Production.....	22-9
22.5	Royalties.....	22-10
22.6	Operating Costs.....	22-10
22.7	Closure Costs.....	22-10
22.8	Taxation.....	22-11
22.8.1	Value Added Tax (IVA).....	22-11
22.8.2	Federal Income Tax	22-11
22.8.3	Special Mining Tax	22-11
22.8.4	Zacatecas Environmental “Green Tax”	22-11
22.8.5	Depreciation	22-12
22.8.6	Loss Carry Forward.....	22-12
22.9	Economic Model & Cash Flow.....	22-13
22.10	Sensitivity	22-17
23.0	ADJACENT PROPERTIES	23-1
24.0	OTHER RELEVANT DATA AND INFORMATION	24-1
24.1	Current Project Status	24-1
24.2	Project Implementation.....	24-1
24.2.1	Project Development.....	24-1
24.2.2	Project Controls.....	24-1
24.2.3	Procurement and Logistics.....	24-2
24.2.4	Construction	24-2
24.2.5	Construction Schedule	24-3
24.3	Site Geotechnical Analyses.....	24-5
24.3.1	Heap Leach Pad Stability	24-5
24.4	Hydrogeology	24-5
24.4.1	Occurrence and Movement of Groundwater	24-6
24.4.2	Groundwater Quality and Use	24-10

24.4.3	Drilling and Aquifer Testing	24-14
24.4.4	Groundwater Simulations of Projected Mine Dewatering	24-15
24.4.5	Summary of Simulation Results	24-16
24.4.6	Model Limitations	24-19
24.5	Sulphides.....	24-20
25.0	INTERPRETATIONS AND CONCLUSIONS	25-1
25.1	Conclusions	25-1
25.1.1	Mining.....	25-1
25.1.2	Metallurgy and Process.....	25-1
25.1.3	Environmental and Permitting	25-2
25.2	Opportunities	25-4
25.2.1	Mining.....	25-4
25.2.2	Mineral Resource	25-4
25.2.3	Metallurgy and Process.....	25-4
25.2.4	New Mineral Zones	25-5
25.3	Risks.....	25-5
25.3.1	Mining.....	25-5
25.3.2	Metallurgy and Process.....	25-5
25.3.3	Access, Title and Permitting.....	25-6
25.3.4	Other Risks.....	25-7
26.0	RECOMMENDATIONS.....	26-1
26.1	KCA Recommendations	26-1
26.2	RGI Recommendations	26-1
26.3	John Ward, CPG, Groundwater Consultant Recommendations.....	26-2
27.0	REFERENCES.....	27-1
28.0	DATE AND SIGNATURE PAGE	28-1

FIGURES

Figure 1.1 After-Tax IRR vs. Gold Price, Capital Cost, Operating Cost & Exchange Rate.....	1-25
Figure 1.2 NPV @ 5% vs. Gold Price, Capital Cost, Operating Cost & Exchange Rate	1-25
Figure 4.1 Location Map, Camino Rojo Project	4-1
Figure 4.2 Mining Concessions, Camino Rojo Property	4-4
Figure 4.3 Surface rights in Project Area	4-8
Figure 5.1 Project Location and Regional Infrastructure.....	5-2
Figure 5.2 View of Typical Topography and Vegetation at Camino Rojo	5-3
Figure 6.1 Historical Drillhole Locations and Project Claim Boundaries	6-3
Figure 7.1 Regional Geologic Map (Servicio Geológico Mexicano, 2000).....	7-3
Figure 7.2 Local Geology, Camino Rojo Deposit (Servicio Geológico Mexicano, 2014)	7-5
Figure 7.3 Drillcore from CR12-345D, 818m	7-6
Figure 7.4 Drillcore from CR12-345D, 254m	7-6
Figure 7.5 Drillcore from CR12-345D, 993m	7-7
Figure 7.6 Drillcore from CR12 345D, 395m.....	7-9
Figure 7.7 Drillcore from CR12 345D, 727m.....	7-9
Figure 7.8 Drillcore from CR11 267D, 490m.....	7-10
Figure 7.9 Drillcore from CR11 267D, 473m.....	7-10
Figure 7.10 Drillcore from CR11 258D, 256m.....	7-12
Figure 7.11 Drillcore from CR11 258D, 257m.....	7-12
Figure 9.1 Exploration Targets and Chargeability Features from Orla's 2018, 2019, and 2020 IP Surveys.....	9-2
Figure 10.1 Drilling by Type, IMC 2019	10-7
Figure 10.2 Drilling by Company, IMC 2019	10-8
Figure 13.1 Column Leach Test Sample Locations (Orla, 2019).....	13-2
Figure 13.2 Preg-Robbing Percentage vs. CIL & Direct Bottle Roll Leach Test Recoveries – KCA 2014	13-29
Figure 13.3 Preg-Robbing Percentage vs. CIL & Direct Bottle Roll Leach Test Recoveries – KCA 2015	13-30
Figure 13.4 CIL-Direct Bottle Roll Au Extraction Difference vs. Organic Carbon Content – KCA 2015	13-30
Figure 13.5 Sample Drillhole Locations for KCA 2019 Test Program	13-33
Figure 13.6 Water Wash Summary.....	13-45
Figure 13.7 Detoxification Summary, INCO SO ₂	13-45
Figure 13.8 Diagnostic Leach Results Summary – KCA 2019	13-47
Figure 13.9 Kp Oxide Recovery vs. Crush Size.....	13-50
Figure 13.10 Ki Oxide Recovery vs. Crush Size.....	13-51
Figure 13.11 Trans-Hi Recovery vs. Crush Size.....	13-51
Figure 13.12 Trans-Lo Recovery vs. Crush Size	13-52

Figure 13.13 Organic Carbon Versus Preg-Robbing	13-56
Figure 13.14 Areas with +10% Preg-Robbing Test Results.....	13-57
Figure 13.15 Recovery Versus Preg-Robbing	13-57
Figure 14.1 Mineral Resource Constraining Cone Shell, IMC 2019	14-9
Figure 14.2 Hole and Cross Section Locations, IMC 2019	14-11
Figure 14.3 Lithology on Section L112, IMC 2019	14-12
Figure 14.4 Alteration on Section L112, IMC 2019	14-15
Figure 14.5 Alteration on Section 18, IMC 2019	14-16
Figure 14.6 Alteration on Section 29, IMC 2019	14-17
Figure 14.7 Oxidation Zones on Section 29, IMC 2019	14-18
Figure 14.8 Estimation Domains on Section L112, IMC 2019	14-19
Figure 14.9 Probability Plot of Gold Assays by Alteration Type – NE Domain	14-24
Figure 14.10 Probability Plot of Gold 5m Composites by Alteration Type – NE Domain	14-24
Figure 14.11 Probability Plot of Gold Assays by Alteration Type – SW Domain.....	14-25
Figure 14.12 Probability Plot of Gold 5m Composites by Alteration Type – SW Domain	14-25
Figure 14.13 Probability Plot of Gold Assays by Alteration Type – Indidura.....	14-26
Figure 14.14 Probability Plot of Gold 5m Composites by Alteration Type – Indidura	14-26
Figure 14.15 NE Domain Gold Variogram – Primary Axis	14-28
Figure 14.16 NE Domain Gold Variogram – Secondary Axis	14-29
Figure 14.17 NE Domain Gold Variogram – Tertiary Axis	14-30
Figure 14.18 SW Domain Gold Variogram – Primary Axis	14-31
Figure 14.19 SW Domain Gold Variogram – Down Hole Variogram	14-32
Figure 14.20 Gold Grades on Section 29, IMC 2019.....	14-35
Figure 14.21 Gold Grades on Section 18, IMC 2019.....	14-36
Figure 14.22 Gold Grades on Section L112, IMC 2019.....	14-37
Figure 14.23 Average Distance to Nearest 3 & 4 Holes – NE Kp & Ki Domains	14-40
Figure 14.24 Average Distance to Nearest 3 & 4 Holes – SW Kp & Ki Domains	14-41
Figure 14.25 Average Distance to Nearest 3 & 4 Holes – Indidura Kp & Ki Domains	14-42
Figure 14.26 Resource Categories on Section 18, IMC 2019	14-43
Figure 14.27 Resource Categories on Section 29, IMC 2019	14-44
Figure 16.1 Slope Angle Recommendations, Piteau 2019	16-3
Figure 16.2 Final Pit, IMC 2019	16-5
Figure 16.3 Mining Phase 1, IMC 2019	16-6
Figure 16.4 Mining Phase 2, IMC 2019	16-7
Figure 16.5 End of Preproduction, IMC 2019	16-16
Figure 16.6 End of Year 1, IMC 2019	16-17
Figure 16.7 End of Year 2, IMC 2019	16-18
Figure 16.8 End of Year 3, IMC 2019	16-19
Figure 16.9 End of Year 4, IMC 2019	16-20
Figure 16.10 End of Year 5, IMC 2019	16-21

Figure 16.11	End of Year 6, IMC 2019	16-22
Figure 16.12	End of Year 7, IMC 2019	16-23
Figure 16.13	End of Year 8 2019.....	16-24
Figure 16.14	Year 9 – End of Mining, IMC 2019.....	16-25
Figure 16.15	Year 10 – End of Waste Storage Capping, IMC 2019	16-26
Figure 16.16	Year 11 – End of Low Grade Reclaim, IMC 2019.....	16-27
Figure 17.1	Process Overall Flowsheet	17-4
Figure 17.2	Project General Arrangement	17-5
Figure 17.3	Average Year Water Balance Diagram.....	17-19
Figure 17.4	Wet Year Water Balance Diagram.....	17-20
Figure 17.5	Dry Year Water Balance Diagram	17-21
Figure 17.6	Merrill-Crowe Recovery Plant & Refinery Layout	17-23
Figure 20.1	Camino Rojo Project Closure Schedule	20-13
Figure 20.2	Permitting Process Flowsheet	20-26
Figure 20.3	Medical Clinic in San Tiburcio – ERM 2018.....	20-32
Figure 20.4	Home in El Berrendo – ERM 2018	20-34
Figure 20.5	Unoccupied Home in San Francisco de los Quijano – ERM 2018.....	20-34
Figure 20.6	Town Plaza in San Tiburcio – ERM 2018.	20-35
Figure 20.7	Public Plaza in La Fabrica (part of San Tiburcio) – ERM 2018.	20-35
Figure 22.1	Annual Gold Production.....	22-9
Figure 22.2	Annual Silver Production	22-9
Figure 22.3	After Tax Sensitivity – IRR.....	22-18
Figure 22.4	After Tax Sensitivity – NPV @ 5%.....	22-18
Figure 24.1	Project Development & Implementation Schedule	24-4
Figure 24.2	Regional Groundwater Elevation Contours, Camino Rojo Project, Zacatecas....	24-8
Figure 24.3	Project Area Groundwater Elevation Contours, Camino Rojo Project, Zacatecas	24-9
Figure 24.4	Total Dissolved Solids in Groundwater.....	24-14
Figure 24.5	Simulation Dewatering Rates for Law and High K Scenarios, Camino Rojo Project, Zacatecas	24-17
Figure 24.6	Simulated Extent of 1 Metre Drawdown Contour for High K Case, Camino Rojo Project, Zacatecas	24-18
Figure 24.7	Simulated Extent of 1 Metre Drawdown Contour for Low K Case, Camino Rojo Project, Zacatecas	24-19

TABLES

Table 1-1 Mineral Resource Estimate – Gold and Silver (Inclusive of Mineral Reserve)..... 1-9

Table 1-2 Mineral Resource Estimate – Zinc and Lead..... 1-9

Table 1-3 Mineral Reserve Estimate..... 1-12

Table 1-4 Capital Cost Summary..... 1-19

Table 1-5 Operating Cost Summary 1-20

Table 1-6 Economic Analysis Summary 1-24

Table 4-1 Listing of Mining Concessions 4-3

Table 10-1 Summary of Camino Rojo Drilling, 2007-2018 10-1

Table 10-2 Drillholes by Orla Included in Mineral Resource Model Database..... 10-4

Table 10-3 Non-Resource Drilling Completed by Orla, 2018, 2019 and 2020..... 10-5

Table 13-1 Oxide Column Test Results - SGS Mineral Services 2009..... 13-4

Table 13-2 Transition Column Test Results - SGS Mineral Services 2009 13-5

Table 13-3 Bottle Roll Test Results CRM 06 Composites - SGS Mineral Services 2009 13-5

Table 13-4 Bottle Roll Test Results CRM 14 Composites - SGS Mineral Services 2009 13-6

Table 13-5 Bottle Roll Test Results CRM 20 Composites - SGS Mineral Services 2009 13-6

Table 13-6 Transition & Sulphide Samples for Flotation Tests - SGS Mineral Services 2009..... 13-7

Table 13-7 Head Analysis Gold & Silver – KCA 2010 13-9

Table 13-8 Carbon & Sulphur Summary – KCA 2010 13-9

Table 13-9 Mercury & Copper Summary – KCA 2010..... 13-10

Table 13-10 Composite Cyanide Shake Tests Results Summary – KCA 2010..... 13-11

Table 13-11 Column Leach Test Results on Composites – KCA 2010 13-12

Table 13-12 Head Analysis Gold & Silver– KCA 2012 13-14

Table 13-13 Head Analysis Carbon & Sulphur– KCA 2012..... 13-14

Table 13-14 Head Analysis Mercury & Copper– KCA 2012 13-15

Table 13-15 Bottle Roll Leach Tests Summary, Gold– KCA 2012 13-17

Table 13-16 Bottle Roll Leach Tests Summary, Silver– KCA 2012 13-18

Table 13-17 KCA 2012 Summary of Column Leach Test Results by Material Type 13-20

Table 13-18 Summary of Flotation Composite Feed Grades 13-22

Table 13-19 Lead Flotation Concentrate Grades..... 13-22

Table 13-20 Zinc Flotation Concentrate Grades..... 13-22

Table 13-21 Comminution Test Results Summary 13-23

Table 13-22 Comminution Test Results by Alteration Type..... 13-23

Table 13-23 Description of Received Material– KCA 2014..... 13-25

Table 13-24 Description of Received Material– KCA 2015..... 13-26

Table 13-25 Head Analyses, Gold & Silver– KCA 2015 13-27

Table 13-26 Head Analyses Carbon & Sulphur– KCA 2015..... 13-27

Table 13-27 Head Analyses Mercury & Copper– KCA 2015 13-28

Table 13-28 KCA 2015 Column Leach Test Results by Lithology 13-32

Table 13-29	Description of Received Material – KCA 2019.....	13-34
Table 13-30	Composite Generation Information – KCA 2019	13-35
Table 13-31	Head Analyses Gold & Silver – KCA 2019	13-36
Table 13-32	Head Analyses Carbon & Sulphur – KCA 2019.....	13-36
Table 13-33	Head Analyses Mercury & Copper – KCA 2019	13-37
Table 13-34	Head Analyses Lead & Zinc – KCA 2019	13-37
Table 13-35	Head Analyses Multi-Element Analysis – KCA 2019	13-38
Table 13-36	Head Analyses Whole Rock Analysis – KCA 2019	13-39
Table 13-37	Physical Characterization Test Work Summary – KCA 2019	13-40
Table 13-38	Bottle Roll Leach Test Summary, Gold – KCA 2019	13-40
Table 13-39	Bottle Roll Leach Test Summary, Silver – KCA 2019.....	13-41
Table 13-40	Column Leach Tests Results Summary, Gold – KCA 2019.....	13-43
Table 13-41	Column Leach Tests Results Summary, Silver – KCA 2019	13-44
Table 13-42	Diagnostic Leach Test Summary – KCA 2019	13-46
Table 13-43	Estimated Recoveries by Material Type for P ₈₀ 28mm Crush Size.....	13-52
Table 13-44	Projected Field Cyanide Consumptions by Material Type	13-53
Table 13-45	Projected Field Lime Consumptions by Material Type.....	13-54
Table 13-46	Distribution of Metals to Various Sulphide Products	13-59
Table 14-1	Mineral Resource Estimate – Gold and Silver (Inclusive of Mineral Reserve).....	14-2
Table 14-2	Mineral Resource Estimate – Zinc and Lead.....	14-3
Table 14-3	Economic Parameters for Mineral Resource Estimate	14-5
Table 14-4	Treatment Costs for Lead and Zinc Concentrates.....	14-6
Table 14-5	Camino Rojo Model Rock Types (lith)	14-10
Table 14-6	Camino Rojo Alteration Types (alt).....	14-13
Table 14-7	Camino Rojo Oxide-Sulphide Model (oxide).....	14-13
Table 14-8	Camino Rojo Estimation Domains (domain).....	14-14
Table 14-9	Cap Grades and Number of Assays Capped	14-21
Table 14-10	Summary Statistics of Assays	14-22
Table 14-11	Summary Statistics of 5m Composites	14-23
Table 14-12	Specific Gravity and Bulk Density	14-45
Table 14-13	Reconciliation of 2018 versus 2019 Mineral Resource - Leach Material.....	14-48
Table 14-14	Reconciliation of 2018 versus 2019 Mineral Resource - Mill Material	14-48
Table 14-15	Reconciliation of 2018 versus 2019 Mineral Resource - Leach & Mill Material	14-49
Table 15-1	Mineral Reserve Estimate.....	15-2
Table 15-2	Economic Parameters for Mine Design	15-5
Table 16-1	Mine Production Schedule - 6,570 KTPY	16-10
Table 16-2	Proposed Plant Production Schedule - 6,570 KTPY	16-11
Table 16-3	Proposed Plant Production Schedule by Material Type - 6,570 KTPY	16-12
Table 16-4	Mine Waste by Material Type	16-13
Table 16-5	Mine Major Equipment Fleet Requirement	16-28

Table 17-1 Processing Design Criteria Summary	17-2
Table 17-2 Heap Leach Design Parameters.....	17-11
Table 17-3 Phase 1 Process Pond Storage Requirements	17-15
Table 17-4 Phase 2 Process Pond Storage Requirements	17-15
Table 17-5 Phase 3 Process Pond Storage Requirements	17-16
Table 17-6 Average Monthly Precipitation – San Tiburcio Weather Station	17-16
Table 17-7 24-h Storm Event Estimations – NewFields	17-17
Table 17-8 Average Monthly Evaporation Data – Conception del Oro Weather Station	17-17
Table 17-9 Average Make-up Water Requirements	17-18
Table 17-10 Projected Annual Reagents and Consumables	17-27
Table 18-1 Camp Capacity	18-3
Table 18-3 Power Demand	18-8
Table 20-1 Summary of Camino Rojo Closure Costs	20-21
Table 20-2 Permits Required for Mine Construction.....	20-24
Table 20-3 Permits Required for Mine Operation and Closure.....	20-25
Table 20-4 Populations of Communities in Area of Influence of Project.....	20-29
Table 20-5 Marginalization by Community.....	20-36
Table 21-1 Capital Cost Summary	21-1
Table 21-2 LOM Operating Cost Summary	21-1
Table 21-3 Summary of Pre-Production Capital Costs by Area.....	21-3
Table 21-4 LOM Mining Capital Costs	21-4
Table 21-5 Owner Mining Equipment Capital Costs	21-5
Table 21-6 Mine Development Capital Costs	21-5
Table 21-7 Summary of Process & Infrastructure Pre-Production Capital Costs by Discipline.....	21-7
Table 21-8 Process Mobile Equipment	21-11
Table 21-9 Process & Infrastructure Contingency	21-12
Table 21-10 Construction Indirect Costs.....	21-13
Table 21-11 Initial Fills	21-14
Table 21-12 Contract Mining Cost Summary	21-17
Table 21-13 Contract Mining Costs Based on Unit Rates	21-19
Table 21-14 Contract Blasting Costs Based on Unit Rates	21-19
Table 21-15 Owner Mine Personnel & Technical Services.....	21-20
Table 21-16 Average Process, Support & G&A Operating Cost.....	21-21
Table 21-17 Personnel & Staffing Summary.....	21-23
Table 21-18 Support Equipment Operating Costs	21-26
Table 21-19 Fixed G&A Expenses.....	21-27
Table 21-20 G&A Expenses by Year	21-28
Table 22-1 Key Economic Parameters	22-3
Table 22-2 Economic Analysis Summary	22-4
Table 22-3 Capital Expenditures Summary	22-8

Table 22-4 LOM Operating Costs	22-10
Table 22-5 Depreciation and Pre-Production Tax Pools.....	22-12
Table 22-6 Cashflow Model Summary	22-14
Table 22-7 After-Tax Sensitivity Analysis Results	22-17
Table 24-1 Summary of Groundwater Quality Analyses from On-Site (COPE) Wells	24-12
Table 24-2 Summary of Groundwater Quality Analyses from Community Wells.....	24-13

1.0 SUMMARY

1.1 Introduction and Overview

The Camino Rojo property, located in Zacatecas State, Mexico, is 100% owned by Orla Mining Ltd. (Orla) through its Mexican subsidiary Minera Camino Rojo S.A. de C.V. (MCR). At the request of Orla, this Technical Report was prepared by Kappes, Cassidy and Associates (KCA), Independent Mining Consultants, Inc. (IMC), Resource Geosciences Incorporated (RGI) and John Ward Groundwater Consultant, CPG (Ward) with input from other consultant groups.

This Technical Report is an update of a previously completed Technical Report and Feasibility Study on the Camino Rojo Project and has been prepared in accordance with disclosure and reporting requirements set forth in the Canadian Securities Administrators' current "Standards of Disclosure for Mineral Projects" under the provisions of National Instrument 43-101 (NI 43-101), Companion Policy 43-101 CP and Form 43-101F1 and supersedes a Technical Report prepared by KCA dated 25 June 2019, "Feasibility Study NI 43-101 Technical Report on the Camino Rojo Gold Project Municipality of Mazapil, Zacatecas, Mexico" (2019 Technical Report).

The primary change between this Technical Report and the 2019 Technical Report is the completion of an agreement with Fresnillo plc and two of its Mexican subsidiaries (Fresnillo) which provides Orla with the right to extend the north wall of the proposed open pit across the north boundary of Orla's property. The Camino Rojo Project is currently in development with engineering, procurement and construction management (EPCM) activities in progress. Updates to costs from these activities are included in this updated Technical Report.

The Camino Rojo Project considers open pit mining of approximately 67.4 million tonnes of ore with an estimated grade of 0.73 grams per tonne (g/t) gold and 14.5 g/t silver. Ore from the pit will be crushed to 80% passing 28mm, conveyor stacked onto a heap leach pad and leached using a low concentration sodium cyanide solution. Pregnant solution from the heap leach will be processed in a Merrill-Crowe recovery plant where gold and silver will be precipitated from deaerated pregnant solution with ultra-fine zinc. The resulting precious metal sludge will be filtered and dried in a mercury retort, and then smelted to produce the final doré product.

The average processing throughput rate for the Camino Rojo Project will be 18,000 tonnes of ore per day (tpd). The Project will be developed in three stages with expansion of the leach pad and addition of conveying equipment occurring in Year 2 and Year 5 of operation. Pit dewatering equipment including pumps and evaporators are required in Year 5 of operation and are assumed to be purchased during Year 3. The scope of this Feasibility Study includes a mine production schedule, as well as costing for all mining and process components as well as infrastructure

required for the operation. This Technical Report is based on the oxide and transitional portion of the Measured and Indicated Mineral Resource on the Property.

1.2 Property Description and Ownership

The Camino Rojo property is located in the Municipality of Mazapil, State of Zacatecas, near the village of San Tiburcio. The property lies 190 kilometres (km) NE of the city of Zacatecas, 48km S-SW of the town of Concepción del Oro, Zacatecas, and 54km S-SE of Newmont Corporation's (Newmont) Peñasquito Mine. The Project area is centred at approximately 244150E 2675900N UTM NAD27 Zone 14N.

The property mineral rights are held by Orla's Mexican subsidiary Minera Camino Rojo SA de CV (MCR) in 7 mining concessions covering approximately 1,631 km². Surface rights are held by the Ejido San Tiburcio, a communal agrarian cooperative. Exploration has been carried out under the authority of agreements between the project operators and the Ejido San Tiburcio. There is a temporary occupation agreement in place with the Ejido San Tiburcio, including a right to expropriate, that covers all the area of the Mineral Resource and Mineral Reserve estimates as well as the area of potential development described in the 2019 Technical Report. MCR has water rights for sufficient volumes of water to develop the Project.

On 21 December 2020, Orla announced that it had entered into an agreement (the "Layback Agreement") with Fresnillo, granting Orla the right to expand the Camino Rojo oxide pit onto a portion of Fresnillo's 782 ha. "Guachichil D1" mineral concession, Title 245418, located immediately to the north of Orla's property. The Layback Agreement allows Orla access to oxide and transitional heap leachable Mineral Resources on Orla's property below the open pit outlined in the 2019 Technical Report. In addition, the Layback Agreement grants Orla the right to mine from Fresnillo's mineral concession, and recover for Orla's account, all oxide and transitional material amenable to heap leaching that are within an expanded open pit. Fresnillo controls surface rights needed to expand the Camino Rojo oxide pit as defined in this Technical Report. The Layback Agreement grants MCR the right to acquire the surface access rights to mine on 21.8 ha. of the Guachichil D1 mining concession that covers the area outside of the Orla concession required for the project as defined in this Technical Report. Closing of the Layback Agreement is subject to receipt of Mexican antitrust approval from the Federal Competition Commission (Comisión Federal de Competencia Económica or "COFECE").

1.3 Geology & Mineralization

The Camino Rojo deposit comprises intrusive related, clastic sedimentary strata hosted, polymetallic gold, silver, arsenic, zinc and lead mineralization.

Mineralization is hosted by Cretaceous submarine sedimentary strata, dominantly clastic. The most important host is the Caracol Formation, a rhythmically interbedded sequence of weakly calcareous turbiditic sandstones, siltstones and shales. The underlying Indidura Formation, comprised of regularly bedded reduced siltstones and shales, and the Cuesta del Cura limestone, now recrystallized to white fine-grained marble, host a minor amount of sulphide mineralization, but are inconsequential hosts of oxide mineralization. The gold-silver-lead-zinc deposit is situated above, and extends down into, a zone of feldspathic hornfels developed in the sedimentary strata, and variably mineralized dacitic dikes. The mineralized zones correspond to zones of sheeted sulphidic veins and veinlet networks, creating a bulk-mineable style of gold mineralization. Skarn mineralization has been encountered in the deeper portions of the system. The observed geologic and geochemical characteristics of the gold-silver-lead-zinc deposit at Camino Rojo are consistent with those of a distal oxidized gold skarn deposit. The metal suite and style of mineralization at Camino Rojo are similar to the intrusion-related deposits in the Caracol Formation and underlying carbonate rocks adjacent to the diatremes at the Peñasquito mine.

For purposes of this Technical Report, only the economic potential of the oxide and partially oxidized transitional mineralization amenable to gold and silver recovery via standard cyanide heap leach processing, was evaluated.

1.4 Exploration and Drilling

The Camino Rojo deposit was discovered in mid-2007 and was originally entirely concealed beneath post-mineral cover in a broad, low relief alluvial valley adjacent to the western flank of the Sierra Madre Oriental. Mineralized road ballast placed on a dirt road near San Tiburcio, Zacatecas, was traced to its source by geologists Perry Durning and Bud Hillemeier from La Cuesta International, working under contract to Canplats Resources Corporation (Canplats). A shallow pit excavated through a thin veneer of alluvium, located adjacent to a stock pond (represa) was the discovery exposure of the deposit. Canplats began concurrent programs of surface geophysics and reverse-circulation (RC) drilling in late 2007, which continued into 2008.

The initial drilling was focused on a 450 x 600 metre gold-in-rock geochemical anomaly named the Represa zone. Core drilling began in 2008. The geophysical survey defined two principal areas of high chargeability: one centred on the Represa zone and another 1 km to the west named the Don Julio zone. The elevated chargeability zones were interpreted as large volumes of sulphide mineralized rocks. Drilling by Canplats, and later drilling by Goldcorp Inc. (Goldcorp), confirmed the presence of extensive sulphide mineralization at depth in the Represa zone, and much lower quantities of sulphide minerals at Don Julio, which is an extension of the Represa zone mineralization.

By August of 2008, Canplats drilled a total of 92 RC, and 30 diamond-core holes, for a total of 23,988 and 16,044 metres respectively, mainly focused in the Represa zone.

Canplats was acquired by Goldcorp in early 2010. Validation, infill, condemnation, and expansion drilling began in January 2011. By the end of 2015, a total of 279,788 metres of new core drilling in 415 drillholes and 20,569 metres of new RC drilling in 96 drillholes was completed in the Represa and Don Julio zones and their immediate surroundings. An additional 31,286 metres of shallow rotary air blast (RAB)-style, RC drilling in 306 drillholes was completed, with most of the RAB drilling testing other exploration targets within the concession. Airborne gravity, magnetic and TEM surveys were also carried out. As of the end of 2015, a total of 295,832 metres in 445 diamond core holes, 44,557 metres in 188 RC drillholes, and 31,286 metres of RAB drilling had been completed.

Orla acquired the property from Goldcorp in 2017 and through the effective date of this Technical Report, Orla has completed additional drilling included in the Mineral Resource model database of 1,345.00 metres in 5 diamond core holes and 803.1 metres in 6 RC holes as resource infill drillholes. Orla also completed additional drilling not included in the Mineral Resource model database comprising 7,759.0 metres of drilling in 26 reverse circulation drillholes conducting regional exploration; 2,288.5 metres of drilling in 14 diamond core holes for metallurgical sampling; 1,959.7 metres of drilling in 3 diamond core holes testing the sulfide zone; 642 metres of drilling in 4 diamond drillholes for geotechnical and condemnation purposes; 1,767.8 metres of drilling in 7 RC holes as condemnation holes; 323.4 metres of drilling in 19 shallow diamond core holes as geotechnical tests of the substrate in the areas of proposed mine infrastructure; 56 metres of drilling in 5 diamond core holes evaluating clay sources for pond liner material; 5,340.5 metres of drilling in 16 reverse circulation holes testing for water; 916.51 metres of RC drilling to construct 11 monitoring wells, and 715.6 metres of drilling for water production wells..

1.5 Metallurgical Test Work

Historical metallurgical test work programs on the Camino Rojo property were commissioned by the prior operators of the Project between 2010 and 2015. A confirmatory metallurgical test program was commissioned by Orla in 2018 to confirm the results and conclusions from the previous campaigns. In total, 107 column leach tests (85 on representative samples for the material types and pit area) and 164 bottle roll tests have been completed to date on the Camino Rojo ore body as well as physical characterization and preliminary flotation test work. The metallurgical results in this Technical Report are based on previous results as no new relevant metallurgical testing has been completed since the release of the 2019 Technical Report.

Based on the metallurgical tests completed on the deposit, key design parameters for the Project include:

- Crush size of 100% passing 38mm (P_{80} 28mm).

- Estimated gold recoveries (including 2% field deduction) of:
 - 70% for Kp Oxide;
 - 56% for Ki Oxide;
 - 60% for Trans-Hi; and
 - 40% for Trans-Lo.
- Estimated silver recoveries (including 3% field deduction) of:
 - 11% for Kp Oxide;
 - 15% for Ki Oxide;
 - 27% for Trans-Hi and
 - 34% for Trans-Lo.
- Design leach cycle of 80 days.
- Agglomeration with cement not required for permeability or stability.
- Average cyanide consumption of 0.35 kilograms per tonne (kg/t) ore.
- Average lime consumption of 1.25 kg/t ore.

The key design parameters are based on a substantial number of metallurgical tests including 85 column leach tests on samples representative of domains in the current deposit model. These 85 representative samples from documented drillholes with good spatial distribution in the proposed pit include 41 column tests on Kp Oxide material, 7 column tests on Ki Oxide material, 16 column tests on Trans-Hi material and 21 column tests on Trans-Lo material. The 22 non-representative columns were excluded based on the following criteria:

- Columns on Trans-S or sulphide material that were not considered in the Mineral Reserve.
- Mix of Tran-S or other material types.
- Samples taken from outside of the proposed pit area.

An additional 54 bottle roll leach tests with direct correlations with the column tests have been included as part of the evaluation to support these results and conclusions.

In general, the Camino Rojo deposit shows variability in gold and silver recoveries based on material type and geological domain with preg-robbing organic carbon being the only significant deleterious element identified, which is primarily associated with the transition material at depth along the outer edges of the deposit. Recoveries for the oxide material are good and will yield acceptable results using conventional heap leaching methods with cyanide. Recoveries for the transition material are lower compared with the oxide material for conventional leaching with some areas of transition showing reasonably high recoveries. Reagent consumptions for all material types are reasonably low.

Preg robbing, a phenomenon where gold and gold-cyanide complexes are preferentially absorbed by carbonaceous, and to a lesser extent, other material within the orebody; presents a low risk to

the overall Project. A significant investigation by Orla into the preg robbing material indicates that potentially preg robbing material represents a small percentage of the total material to be processed and will not be encountered until later in the Project life and can be mitigated by proper ore control.

1.6 Mineral Resource Estimate

No update to the Mineral Resource estimate was made as part of this updated Feasibility Study. Table 1-1 presents the gold and silver Mineral Resource estimation for the Camino Rojo property. Measured and Indicated Mineral Resources amount to 353.4 million tonnes at 0.83 g/t gold and 8.8 g/t silver. Contained metal amounts to 9.46 million ounces gold and 100.4 million ounces of silver for the Measured and Indicated Mineral Resources. Inferred Mineral Resource is an additional 60.9 million tonnes at 0.87 g/t gold and 7.4 g/t silver. Contained metal amounts to 1.70 million ounces of gold and 14.5 million ounces of silver for the Inferred Mineral Resource. The effective date of the Mineral Resource estimate is 7 June 2019. There has been no new drilling for the Mineral Resource estimation since the 2019 Technical Report and the Mineral Resource estimation is the same as presented in the 2019 Technical Report.

The gold and silver Mineral Resource includes material amenable to heap leach recovery methods (leach material) and material amenable to mill and flotation concentration methods (mill material). For the leach material, Measured and Indicated Mineral Resources amount to 94.6 million tonnes at 0.71 g/t gold and 12.7 g/t silver. Contained metal amounts to 2.16 million ounces gold and 38.8 million ounces of silver for the Measured and Indicated Mineral Resources. Inferred Mineral Resource is an additional 4.4 million tonnes at 0.86 g/t gold and 5.8 g/t silver. Contained metal amounts to 119,800 ounces of gold and 805,000 ounces of silver for the Inferred Mineral Resource amenable to heap leach methods. The resources amenable to heap leach methods are oxide dominant and are the emphasis of the Feasibility Study.

For the gold and silver resource in mill material, the Measured and Indicated Mineral Resources amount to 258.8 million tonnes at 0.88 g/t gold and 7.4 g/t silver. Contained metal amounts to 7.30 million ounces gold and 61.6 million ounces of silver for the Measured and Indicated Mineral Resources. Inferred Mineral Resource is an additional 56.6 million tonnes at 0.87 g/t gold, 7.5 g/t silver. Contained metal amounts to 1.58 million ounces of gold and 13.7 million ounces of silver for the Inferred Mineral Resource in mill material.

Table 1-2 presents the zinc and lead Mineral Resource estimate for the Camino Rojo Project. The zinc and lead Mineral Resources are in sulphide dominant material and are recovered along with the gold and silver in the mill material. Zinc and lead Measured and Indicated Mineral Resources amount to 258.8 million tonnes at 0.26% zinc and 0.07% lead. Contained metal amounts to 1.50 billion pounds of zinc and 413.6 million pounds of lead for the Measured and Indicated Mineral Resource. Inferred Mineral Resource is an additional 56.6 million tonnes at

0.23% zinc and 0.05% lead. Contained metal amounts to 290.4 million pounds of zinc and 63.1 million pounds of lead for the Inferred Mineral Resource category.

The Mineral Resource estimate from the leach material is reported inclusive of those Mineral Resources that were converted to Mineral Reserves presented in Section 1.7. The Mineral Resources from the mill material were excluded from the mine design in the Feasibility Study.

The Mineral Resource estimates are based on a block model developed by IMC during January and February 2019. This updated model incorporated the 2018 Orla drilling and updated geologic models.

The Measured, Indicated, and Inferred Mineral Resources reported herein are constrained within a floating cone pit shell to demonstrate “reasonable prospects for eventual economic extraction” to meet the definition of Mineral Resources in NI 43-101.

All the mineralization comprised in the Mineral Resource estimate with respect to the Project are contained on mineral titles controlled by Orla. However, the Mineral Resource estimate assumes that the north wall of the conceptual floating pit cone used to demonstrate reasonable prospects for eventual economic extraction extends onto lands where mineral title is held by Fresnillo, and that waste would be mined on Fresnillo’s mineral titles. The Layback Agreement allows Orla to expand the Camino Rojo oxide pit onto part of Fresnillo’s mineral concession located immediately north of Orla’s property. This expansion will increase oxide ore available for extraction on Orla’s property below the pit outlined in the 2019 Technical Report.

The Layback Agreement with Fresnillo is only with respect to the portion of the heap leach material included in the current Mineral Reserve. As such, any potential development of the Camino Rojo property that includes an open pit encompassing the entire Mineral Resource estimate is dependent on entering into an additional agreement with Fresnillo (or any potential subsequent owner of the mineral titles). It is estimated that approximately two-thirds of the Mill Resource estimate and one quarter of the Leach Resource comprising the Mineral Resource estimate are dependent on an additional agreement being entered into with Fresnillo. The Leach Resource dependent on the additional agreement is mainly comprised of less oxidized transitional material with the lowest predicted heap-leach recoveries. The Mineral Resource estimate has been prepared based on the Qualified Person’s reasoned judgment, in accordance with Canadian Institute of Mining, Metallurgy and Petroleum (CIM) Best Practices Guidelines and his professional standards of competence, that there is a reasonable expectation that all necessary permits, agreements and approvals will be obtained and maintained, including the additional agreement with Fresnillo to allow mining of waste material on its mineral concessions. In particular, when determining the prospects for eventual economic extraction, consideration was given to industry practice, and a timeframe of 10-15 years.

Delays in, or failure to obtain, an additional agreement with Fresnillo would affect the development of a significant portion of the Mineral Resources of the Camino Rojo property that are not included in the updated Feasibility Study mine plan, in particular by limiting access to significant mineralized material at depth. There can be no assurance that Orla will be able to negotiate such additional agreement on terms that are satisfactory to Orla and Fresnillo or that there will not be delays in obtaining the necessary additional agreement.

**Table 1-1
Mineral Resource Estimate – Gold and Silver (Inclusive of Mineral Reserve)**

Resource Type	NSR Cut-off (\$/t)	Kt	Gold (g/t)	Silver (g/t)	Gold (koz)	Silver (koz)
Leach Resource:						
Measured Mineral Resource	4.73	19,391	0.77	14.9	482.3	9,305
Indicated Mineral Resource	4.73	75,249	0.70	12.2	1,680.7	29,471
Meas/Ind Mineral Resource	4.73	94,640	0.71	12.7	2,163.0	38,776
Inferred Mineral Resource	4.73	4,355	0.86	5.8	119.8	805
Mill Resource:						
Measured Mineral Resource	13.71	3,358	0.69	9.2	74.2	997
Indicated Mineral Resource	13.71	255,445	0.88	7.4	7,221.4	60,606
Meas/Ind Mineral Resource	13.71	258,803	0.88	7.4	7,295.6	61,603
Inferred Mineral Resource	13.71	56,564	0.87	7.5	1,576.9	13,713
Total Mineral Resource						
Measured Mineral Resource		22,749	0.76	14.1	556.5	10,302
Indicated Mineral Resource		330,694	0.84	8.5	8,902.1	90,078
Meas/Ind Mineral Resource		353,443	0.83	8.8	9,458.6	100,379
Inferred Mineral Resource		60,919	0.87	7.4	1,696.7	14,518

**Table 1-2
Mineral Resource Estimate – Zinc and Lead**

Resource Type	NSR Cut off (\$/t)	Kt	NSR (\$/t)	Lead (%)	Zinc (%)	Lead (Mlb)	Zinc (Mlb)
Mill Resource:							
Measured Mineral Resource	13.71	3,358	35.04	0.13	0.38	9.3	28.2
Indicated Mineral Resource	13.71	255,445	39.33	0.07	0.26	404.3	1,468.7
Meas/Ind Mineral Resource	13.71	258,803	39.27	0.07	0.26	413.6	1,496.8
Inferred Mineral Resource	13.71	56,564	38.4	0.05	0.23	63.1	290.4

Notes:

- The Mineral Resource estimate has an effective date of June 7, 2019 and the estimate was prepared using the CIM Definition Standards (May 10, 2014).
- All figures are rounded to reflect the relative accuracy of the estimate and therefore numbers may not appear to add precisely.
- Mineral Resources that are not Mineral Reserves do not have demonstrated economic viability.
- Mineral Resources for leach material are based on prices of \$1400/oz gold and \$20/oz silver.
- Mineral Resources for mill material are based on prices of \$1400/oz gold, \$20/oz silver, \$1.05/lb lead, and \$1.20/lb zinc.
- Mineral Resources are based on NSR cut-off of \$4.73/t for leach material and \$13.71/t for mill material.
- NSR value for leach material is as follows:
Kp Oxide: NSR (\$/t) = 30.77 x gold (g/t) + 0.068 x silver (g/t), based on gold recovery of 70% and silver recovery of 11%.
Ki Oxide: NSR (\$/t) = 24.61 x gold (g/t) + 0.092 x silver (g/t), based on gold recovery of 56% and silver recovery of 15%.
Tran-Hi: NSR (\$/t) = 26.37 x gold (g/t) + 0.166 x silver (g/t), based on gold recovery of 60% and silver recovery of 27%.
Tran-Li: NSR (\$/t) = 17.58 x gold (g/t) + 0.209 x silver (g/t), based on gold recovery of 40% and silver recovery of 34%.
- NSR value for mill material is 36.75 x gold (g/t) + 0.429 x silver (g/t) + 10.75 x lead (%) + 11.77 x zinc (%), based on recoveries of 86% gold, 76% silver, 60% lead, and 64% zinc.
- Table 14-3 accompanies this Mineral Resource statement and shows all relevant parameters.
- Includes 2% NSR royalty and an USD MXN exchange rate of 19.3.
- Mineral Resources are constrained within a conceptual pit shell in order to demonstrate reasonable prospects for eventual economic extraction, to meet the definition of Mineral Resource in NI 43-101; mineralization lying outside of the pit shell is not reported as a Mineral Resource.
- The Mineral Resource estimate requires the floating pit cone used to demonstrate reasonable prospects for eventual economic extraction to extend onto land held by Fresnillo. Any potential development of the Camino Rojo property that includes an open pit encompassing the entire Mineral Resource estimate would be dependent on obtaining an additional agreement with Fresnillo (in addition to the Layback Agreement, which is only with respect to a portion of the heap leach material included in the Mineral Reserve).
- The Mineral Resources in the leach material is inclusive of those Mineral Resources that were converted to Mineral Reserves.

1.7 Mineral Reserve Estimate

Table 1-3 presents the Mineral Reserve estimation for the Camino Rojo Project. The Proven and Probable Mineral Reserve amounts to 67.4 million tonnes at 0.73 g/t Au and 14.5 g/t Ag for 1.59 million contained gold ounces and 31.5 million contained silver ounces. Direct feed material in the Mineral Reserve is material that will be processed the same year it is mined. The low-grade stockpile material will be processed after the open pit is completed. The effective date of this Mineral Reserve estimation is 11 January 2021.

The Mineral Reserve estimation is based on an open pit mine plan and mine production schedule developed by IMC. Processing is based on crushing and heap leaching to recover gold and silver. Table 1-3 shows the parameters used for economic and cut-off calculations. The Mineral Reserve is based on a gold price of US\$1250 per ounce and a silver price of US\$17.00 per ounce. Measured Mineral Resource in the mine production schedule was converted to proven Mineral Reserve and indicated Mineral Resource in the schedule was converted to probable Mineral Reserve.

The Mineral Reserves are classified in accordance with the “CIM Definition Standards – For Mineral Resources and Mineral Reserves” adopted by the CIM Council (as amended, the “CIM Definition Standards”) in accordance with the requirements of NI 43-101. Mineral Reserve estimates reflect the reasonable expectation that all necessary permits and approvals will be obtained and maintained.

Approximately two-thirds of the Mineral Reserves are within the currently permitted mine plan. The remaining portion will require a change of land use (CUS) and related permit amendments for an expanded pit and approval of the Layback Agreement from COFECE and subsequent transfer of surface rights.

IMC does not believe that there are significant risks to the Mineral Reserve estimate based on metallurgical or infrastructure factors, or environmental, permitting, legal, title, taxation, socio-economic, marketing or political factors. There has been a significant amount of metallurgical testing and the infrastructure requirements are relatively straightforward compared to many operations. However, recoveries lower than forecast would result in loss of revenue for the project. There has also been some potentially preg-robbing material identified in the deposit, as discussed in Section 13.5 and 25.3.2, but this does not appear to represent a significant risk.

There is risk to the Mineral Reserve based on mining factors. As discussed in Section 16.2 and 25.3.1, the slope angle assumptions are based on careful application of wall control blasting. Failure of the wall control blasting to perform as expected would result in less ore available for the process plant and potentially a shorter project life.

Other risks to the Mineral Reserve are related to economic parameters such as prices lower than forecast or costs higher than the current estimates. The impact of these is modeled in the sensitivity study with the economic analysis in Section 22.10.

All of the mineralization comprised in the Mineral Reserve estimate with respect to the Camino Rojo Project is contained on mineral titles controlled by Orla. A portion of the waste mining will be on a mineral concession controlled by Fresnillo as per the Layback Agreement between Orla and Fresnillo. Additional work is required to bring material on the Fresnillo concession to the Measured and Indicated Mineral Resource categories. Therefore, all material to be mined on the Fresnillo mineral concession is considered waste in this Technical Report.

**Table 1-3
Mineral Reserve Estimate**

Reserve Class	Ktonnes	NSR (\$/t)	Gold (g/t)	Silver (g/t)	Cont. Gold (koz)	Cont. Silver (koz)
Proven Mineral Reserve						
Direct Feed	15,997	23.04	0.87	16.2	445	8,322
Low Grade Stockpile	2,070	8.03	0.31	9.5	20	629
Total Proven Mineral Reserve	18,067	21.32	0.80	15.4	466	8,951
Probable Mineral Reserve						
Direct Feed	42,123	20.04	0.78	15.2	1,052	20,596
Low Grade Stockpile	7,173	7.77	0.31	8.5	71	1,959
Total Probable Mineral Reserve	49,296	18.25	0.71	14.2	1,123	22,555
Proven/Probable Mineral Reserve						
Direct Feed	58,120	20.86	0.80	15.5	1,497	28,918
Low Grade Stockpile	9,243	7.83	0.31	8.7	92	2,588
Total Proven/Probable Reserve	67,363	19.08	0.73	14.5	1,588	31,506

Notes:

- The Mineral Reserve estimate has an effective date of 11 January 2021 and was prepared using the CIM Definition Standards (10 May 2014).
- Columns may not sum exactly due to rounding.
- Mineral Reserves are based on prices of \$1250/oz gold and \$17/oz silver.
- Mineral Reserves are based on NSR cut-offs that vary by time period to balance mine and plant production capacities (see Section 16). They range from a low of \$4.93/t to a high of \$12.00/t.
- NSR value for leach material is as follows:
 - Kp Oxide: NSR (\$/t) = 27.37 x gold (g/t) + 0.053 x silver (g/t), based on gold recovery of 70% and silver recovery of 11%.
 - Ki Oxide: NSR (\$/t) = 21.90 x gold (g/t) + 0.073 x silver (g/t), based on gold recovery of 56% and silver recovery of 15%.
 - Tran-Hi: NSR (\$/t) = 23.46 x gold (g/t) + 0.131 x silver (g/t), based on gold recovery of 60% and silver recovery of 27%.
 - Tran-Lo: NSR (\$/t) = 15.64 x gold (g/t) + 0.165 x silver (g/t), based on gold recovery of 40% and silver recovery of 34%.
- Table 15-2 accompanies this Mineral Reserve estimate and shows all relevant parameters

1.8 Mining Methods

The Camino Rojo Feasibility Study is based on a conventional open pit mine. Mine operations will consist of drilling medium diameter blast holes (approximately 17cm), blasting with explosive emulsions or ANFO (ammonium nitrate/fuel oil) depending on water conditions, and loading into large off-road trucks with hydraulic shovels and wheel loaders. Ore will be delivered to the primary crusher and waste to the waste storage facility southeast of the pit. There will also be a low-grade stockpile facility to store marginal ore for processing at the end of commercial pit operations. There will be a fleet of track dozers, rubber-tired dozers, motor graders and water trucks to maintain the working areas of the pit, waste storage areas, and haul roads.

A mine plan was developed to supply ore to a conventional crushing and heap leach facility with the capacity to process 18,000 tpd (6,570 ktpy). The mine is scheduled to operate two 10-hour shifts per day for 365 days per year.

The mine plan contained in this Technical Report was prepared on the assumption that Orla would be permitted to expand the Camino Rojo Project oxide pit onto part of Fresnillo's mineral concession located immediately north of Orla's property, that Orla will have access to oxide and transitional heap leachable material, and that Orla would have the right to mine from the Fresnillo mineral concession, and recover for Orla's account, all oxide and transitional material amenable to heap leaching that are within an expanded open pit. In this Feasibility Study, all material to be mined on the Fresnillo mineral concession is classified as waste. Delays in, or failure to obtain, the approval of COFECE for the Layback Agreement and subsequent transfer of surface rights would affect the timetable or cost of development of the potential mine modelled in this Technical Report.

According to the development plans presented in this Technical Report, by Year 5 of commercial operations the pit depths will be below the pre-mining water table. Groundwater modeling of pit dewatering requirements was conducted to evaluate pit inflows and rate of pit lake recovery, and to evaluate off-site long-term impacts to groundwater levels. The modeled dewatering rates were also used by KCA to prepare dewatering and disposal cost estimations.

1.9 Recovery Methods

Test work results developed by KCA and others have indicated that part of the Camino Rojo Mineral Resource is amenable to heap leaching for the recovery of gold and silver. Based on a Mineral Reserve of 67.4 million tonnes and established processing rate of 18,000 tonnes per day of ore, the Project has an estimated mine life of approximately 10.4 years.

Ore will be mined using standard open pit mining methods and delivered to the crushing circuit using haul trucks which will direct-dump into a dump hopper; front-end loaders will feed material

to the dump hopper as needed from a run of mine (ROM) stockpile located near the primary crusher. Ore will be crushed to a final product size of 80% passing 28mm (100% passing 38mm) using a two-stage closed crushing circuit. The crushing circuit will operate 7 days/week, 24 hours/day with an overall estimated availability of 75%.

The crushed product will be stockpiled using a fixed stacker, reclaimed by belt feeders to a reclaim conveyor, and conveyed to the heap stacking system by an overland conveyor system. Pebble lime will be added to the reclaim conveyor belt for pH control; agglomeration with cement is not needed.

Stacked ore will be leached using a drip irrigation system for solution application; sprinkler irrigation will be used beginning in Year 5 of operations to increase evaporation rates and reduce water treatment requirements from pit dewatering. After percolating through the ore, the gold and silver bearing pregnant leach solution will drain by gravity to a pregnant solution vault tank where it will be collected and pumped to a Merrill-Crowe recovery plant. Pregnant solution will be pumped through clarification filter presses to remove any suspended solids before being deaerated in a vacuum tower to remove oxygen. Ultra-fine zinc dust will be added to the deaerated pregnant solution to precipitate gold and silver values, which will be collected by precipitate filter presses. Barren leach solution leaving the precipitate filter presses will flow to a barren solution tank and will then be pumped to the heap for further leaching. High strength cyanide solution will be injected into the barren solution to maintain the cyanide concentration in the leach solutions at the desired levels.

The precipitate from the Merrill-Crowe recovery plant will be processed in the refinery. Precipitate will be treated by an electric mercury retort with a fume collection system for drying and removal of mercury before being mixed with fluxes and smelted using an induction smelting furnace to produce the final doré product.

An event pond and pregnant solution pond are included to collect contact solution from storm or solution surge events. Solution collected will be returned to the process as soon as practical. Evaporators will be installed in the event pond by Year 5, or as needed, to control excess solution generated by pit dewatering.

1.10 Infrastructure

Existing infrastructure for the Camino Rojo Project includes a 40-man exploration camp and dirt and gravel roads throughout the Project site. Internet and limited cellular communications are currently available, though these systems will need to be expanded for operations.

As of the date of this Technical Report, Orla has completed over 90% of the detailed engineering for the project outlined in the 2019 Technical Report and procurement is 85% complete. The start

of earthworks was announced on 26 November 2020. Activities include flora and fauna relocation site clearing and topsoil removal. The 44-kilometre, 34.5-kV power line construction is 49% complete. Equipment deliveries to site commenced in December 2020. A total of \$78 million of the total Project capital has been committed through purchase orders and contracts. The mining contract is being finalized and expected to be in place in the first quarter of 2021.

Access to the Project site is by the paved four-lane Mexican Highway 54 and Route 62, a secondary paved highway that passes through San Tiburcio. This is approximately 260 km southwest of Monterrey and 190 km northeast of Zacatecas. A private road will enter into the mine property approximately 250 metres northeast of the intersection between highway 54 and 62. This road will provide access to the camps, offices, mine, process plant and other Project facilities. Site access roads will be constructed during pre-production and will include approximately 24 km of dirt and gravel roads.

The onsite operations camp will be arranged to lodge 224 persons with a maximum capacity of 448 persons. The operations camp will be constructed early during the construction phase to allow for housing of vendor representatives and consultants during the commissioning phase of the project.

Power supply to the Camino Rojo Project will be available by connecting to the national grid at Concepción del Oro. Overhead powerlines will connect 34.5 kV, three phase and 60 Hz power system to a metering and switching substation located at approximately NAD27 245609E, 2674826N. Power from the main substation will be distributed at 34.5 kV. Emergency power generators will supply electric power to critical process equipment, the mine camp and the raw water pumping system.

Total Project water supply will be sourced from production wells located within the property boundary. Process make-up water will also be supplied by pit dewatering, anticipated to start in Year 5. Total water consumption for the Project will average 24 liters per second (L/s) with a peak water demand of 33 L/s.

Project buildings will primarily be prefabricated steel buildings or concrete masonry unit buildings and include an administration building, mine truck shop, warehouse, laboratory, guard house, clinic, refinery and motor control centres (MCC).

1.11 Environmental Studies, Permitting and Social or Community Impact

Exploration and mining activities in Mexico are subject to control by the Federal agency of the Secretaria del Medio Ambiente y Recursos Naturales (Secretary of the Environment and Natural Resources), known by its acronym SEMARNAT, which has authority over the 2 principal Federal permits:

- i. A Manifesto de Impacto Ambiental (Environmental Impact Statement), known by its acronym as an MIA accompanied by an Estudio de Riesgo (Risk Study, hereafter referred to as ER); and
- ii. A Cambio de Uso de Suelo (Land Use Change) permit, known by its acronym as a CUS, supported by an Estudio Tecnico Justificativo (Technical Justification Study, known by its acronym ETJ).

Exploration work at Camino Rojo has been conducted under the auspices of two separate MIA permits and corresponding CUS permits. These permits allow for extensive exploration drilling.

MIA and CUS permit applications were submitted to SEMARNAT on 29 and 30 August 2019, respectively, for the construction and operation of an open pit mine as per the project described in the 2019 Technical Report. Federal environmental authorities approved this CUS permit in December 2019, Minera Camino Rojo made the requisite payment to the National Forestry Commission (Comision Nacional Forestal) on 23 January 2020, and MCR received the CUS permit on 6 February 2020, via Oficio No. DFZ152-201/20/0196, allowing mine development and operation affecting 816.25 ha. The Project described in this Technical Report will require an additional CUS permit to allow for additional surface disturbances related to development of a pit layback onto lands not considered in the August 2019 permit application. The additional CUS permit is expected to require 3 months for preparation of the application, and an additional 6 months for review and issuance of resolution by SEMARNAT.

MCR received the MIA permit on 11 August 2020, via Oficio No. SGPA/DGIRA/DG/03478, authorizing mine construction and operation of the mine proposed in the 2019 Technical Report. The Project described in this Technical Report, at the discretion of SEMARNAT may require a modification to the MIA permit, or an additional MIA permit, to allow for additional production related to development of a pit layback onto lands not considered in the August 2019 permit application. Process methods and process infrastructure does not change. The MIA modification or additional MIA permit request is expected to require 3 months for preparation of the application, and an additional 6 months for review and issuance of resolution by SEMARNAT.

Federal regulations require staged postings of a bond or financial guarantee for the estimated cost of reclamation, proportional to the pending reclamation work created by the Project in each development phase, as determined by a Technical Economic Study. On 11 November 2020, MCR submitted the required first stage reclamation bond of \$89,451,775 Pesos (approximately \$4.5 M) which was accepted by the Federal Treasury, with formal notice given to the Procuraduria Federal de Proteccion al Ambiente (PROFEPA), on 13 November 2020. All MIA and CUS permit conditions have been satisfied, allowing for site activities to commence for the Project described in the 2019 Technical Report.

MCR received a Municipal Construction Licence on 4 December 2020 from the Mazapil Municipality, authorizing construction of the mine and processing infrastructure as per the project described in the 2019 Technical Report. The Project described in this Technical Report will require a modification to the Municipal Construction License to allow for additional earthworks related to development of a pit layback onto lands not considered in the August 2019 permit application.

MCR currently has all major permits required for construction and operation of the Project described in the 2019 Technical Report. Certain permits, including authorization from SEDENA to use and store explosives, cannot be obtained before facilities are built, and routine surface water management permits from CONAGUA, required for constructing surface drainage diversion works and road crossings, are in process. Receipt of these permits is not expected to affect project timelines. There are no impediments to construction, mining, and processing activities for the already authorized project while permit modifications for the Project described in this Technical Report are in the application process.

Approximately two-thirds of the Mineral Reserves described in this Technical Report are within the currently permitted mine plan. The remaining portion will require permit amendments for an expanded pit and approval of the Layback Agreement from the Mexican Federal Competition Commission (Comisión Federal de Competencia Económica or “COFECE”) and subsequent transfer of surface rights. These permit amendments and approvals are expected to be approved in a reasonable time frame.

Baseline environmental studies required for permitting were commissioned by Orla on April 2018 and were completed in May 2019 by independent consultants. The Project area includes five flora species with legally protected status and nine fauna species that are listed as threatened or protected. In accordance with Federal laws, 100% of the protected plants will be rescued and transplanted prior to construction and qualified biologists will survey the areas to be disturbed to identify nesting areas, dens and lairs of animals present. Any animals not naturally prone to leave the area that are found will be relocated to suitable habitats elsewhere in the property area. Current and ongoing environmental investigations are still in progress.

The Project is not located in an area with any special Federal environmental protection designation and no factors have been identified that would be expected to hinder authorization of required Federal and State environmental permits.

The Peñasquito mine, a large scale, open pit mine, presently operated by Newmont, is in the same Municipality and the mine encountered no impediments to receipt of needed permits.

The authors of this Technical Report believe that the permitting risk for the project is similar to that of any mining project of similar scope in North America.

In April 2018, Orla commissioned Environmental Resources Management (ERM), a global provider of environmental, health, safety, risk, social consulting and sustainability related services to conduct an independent assessment of social and community impacts of the development of the Camino Rojo Project, and to provide guidance on actions and policies needed to ensure that Orla obtains and maintains social license to operate. The study was completed in May 2019 (ERM, 2019) and salient results are being incorporated into the project development and permitting plans. Key points are summarized as follows:

Principal concerns of affected stakeholders in surrounding communities are:

- i. Employment of community members
- ii. Community benefits from improved public services and investment in community development
- iii. Environmental contamination
- iv. Increased community population and strain on public services
- v. Water shortages

Principal concerns of Ejido members whose land is affected are:

- i. Just economic compensation
- ii. Assistance in obtaining title to informally owned parcels

Principal concerns of local and State government authorities are:

- i. Generation of employment
- ii. Improvement of local infrastructure
- iii. Service contracts to local businesses
- iv. Environmental contamination

ERM identified the principal social and community impacts of the Project and opined that the Project does not put at risk the social environment of the nearby communities because the impacts can be mitigated or made positive with the implementation of a Social Management System (SMS). ERM has designed this SMS based on International Association of Impact Assessment best practices.

1.12 Capital and Operating Costs

The capital costs presented have been updated based on the current engineering and construction activities. The costs are based on a combination of the 2019 Technical Report results and on new costs from the ongoing EPCM work. Where updated cost information was not provided, the 2019 Technical Report costs were used. The estimated costs are considered to have an accuracy of +/-15%.

The total Life of Mine (LOM) capital cost for the Project is US\$167.5 million, including US\$9.8 million in working capital and not including reclamation and closure costs which have been estimated at US\$28.6 million, IVA (value added tax) or other taxes; all IVA is applied to all costs at 16% and is assumed to be fully refundable. Table 1-4 presents the capital requirements for the Camino Rojo Project. A total contingency of US\$13.8 million or approximately 10% of the total preproduction capital costs is included in this summary.

**Table 1-4
Capital Cost Summary**

Description	Cost (US\$)
Pre-Production Capital	\$ 134,056,000
Working Capital & Initial Fills	\$ 9,845,000
Sustaining Capital – Mine & Process	\$ 23,565,000
Total excluding IVA	\$ 167,467,000

The average life of mine operating cost for the Project is US\$8.17 per tonne of ore processed. Table 1-5 presents the LOM operating cost requirements for the Camino Rojo Project.

Mining costs were provided by IMC at US\$1.77 per tonne mined (excludes pre-production tonnes; which are capital costs, LOM US\$3.37 per tonne of ore processed) and are based on updated quotes for contract mining with estimated owner’s mining costs.

Process operating costs have been estimated by KCA from first principles. Labour costs were estimated using project specific staffing, salary and wage and benefit requirements. Unit consumptions of materials, supplies, power, water and delivered supply costs were also estimated. LOM average processing costs are estimated at US\$3.20 per tonne ore.

General administrative costs (G&A) have been estimated by KCA with input from Orla. G&A costs include project specific labour and salary requirements and operating expenses, including social contributions, land access and water rights. G&A costs are estimated at US\$1.60 per tonne ore.

Mining costs were estimated based on 1st quarter 2020 US dollars, the remaining operating costs were estimated based on 1st quarter 2019 US dollars and are presented with no added contingency based upon the design and operating criteria present in this Technical Report. IVA is not included in the operating cost estimate.

The operating costs presented are based upon the ownership of all process production equipment and site facilities, including the onsite laboratory. The owner will employ and direct all process operations, maintenance and support personnel for all site activities

**Table 1-5
Operating Cost Summary**

Description	LOM Cost (US\$/t)
Mine	\$3.37
Process & Support Services	\$3.20
Site G & A	\$1.60
Total	\$8.17

1.13 Cautionary Statements

1.13.1 Forward Looking Information

This document contains “forward-looking information” as defined in applicable securities laws. Forward looking information includes, but is not limited to, statements with respect to the FS, including but not limited to future production, costs and expenses of the Project; estimates of Mineral Reserves and Mineral Resources; commodity prices and exchange rates; mine production plans; projected mining and process recovery rates; mining dilution assumptions; timeline for receipt of Mexican antitrust (COFECE) approval and other amended permits; sustaining costs and operating costs; interpretations and assumptions regarding joint venture and potential contract terms; closure costs and requirements; the ability to reach an additional agreement with Fresnillo; government regulations and permitting timelines; requirements for additional capital; environmental, permitting and social risks; and general business and economic conditions. Often, but not always, forward-looking information can be identified by the use of words such as “plans”, “expects”, “is expected”, “budget”, “scheduled”, “estimates”, “continues”, “forecasts”, “projects”, “predicts”, “intends”, “anticipates” or “believes”, or variations of, or the negatives of, such words and phrases, or statements that certain actions, events or results “may”, “could”, “would”, “should”, “might” or “will” be taken, occur or be achieved.

Forward-looking information is based on a number of assumptions which may prove to be incorrect, including, but not limited to, the availability of financing for production, development and exploration activities; the timelines for exploration and development activities on the Project; that

all required licenses, permits and approvals, including Mexican antitrust (COFECCE) approval and subsequent transfer of surface rights, will be obtained; the availability of certain consumables and services; assumptions made in Mineral Resource and Mineral Reserve estimates, including geological interpretation grade, recovery rates, price assumption, and operational costs; general business and economic conditions that political and legal developments will be consistent with current expectations; that commodity prices, and currency and exchange rates, will be consistent with current levels; and that there will be no significant disruptions affecting the Company or its properties. Forward-looking information involves known and unknown risks, uncertainties and other factors which may cause the actual results, performance or achievements to be materially different from any of the future results, performance or achievements expressed or implied by the forward-looking information. These risks, uncertainties and other factors include, but are not limited to delays in or failure to receive required permits, licences and approvals, including Mexican antitrust (COFECCE) approval and subsequent transfer of surface rights, risks related to uncertainties inherent in the preparation of feasibility studies, including but not limited to, the assumptions underlying the production estimates not being realized, changes to the cost of production, variations in quantity of mineralized material, grade or recovery rates, geotechnical or hydrogeological considerations during mining differing from what has been assumed, failure of plant, equipment or processes, changes to availability of power or the power rates used in the cost estimates, changes to salvage values, ability to maintain social license, changes to interest or tax rates, decrease of future gold prices, cost of labour, supplies, fuel and equipment rising, the availability of financing on attractive terms, actual results of current exploration, changes in project parameters, commodity and exchange rate fluctuations, delays and costs inherent to consulting and accommodating rights of local communities, environmental risks, reclamation expenses, title risks, risks relating to COVID-19, regulatory risks and uncertainties with respect to obtaining necessary permits or delays in obtaining same, risks inherent in the estimation of Mineral Reserves and Mineral Resources, including but not limited to, risks that the interpreted drill results may not accurately represent the actual continuity of geology or grade of the deposit, bulk density measurements may not be representative, interpreted and modelled metallurgical domains may not be representative, and metallurgical recoveries may not be representative, and other risks involved in the gold production, development and exploration industry, as well as those risk factors discussed in Orla's latest Annual Information Form and its other SEDAR filings from time to time.

All forward-looking information herein is qualified by this cautionary statement. Accordingly, readers should not place undue reliance on forward-looking information. Orla and the authors of this Technical Report undertake no obligation to update publicly or otherwise revise any forward-looking information whether as a result of new information or future events or otherwise, except as may be required by applicable law.

1.13.2 Non-IFRS Measures

Orla has included certain non-International Financial Reporting Standards (IFRS) performance measures as detailed below. In the gold mining industry, these are common performance measures but may not be comparable to similar measures presented by other issuers and the non-IFRS measures do not have any standardized meaning. Accordingly, it is intended to provide additional information and should not be considered in isolation or as a substitute for measures of performance prepared in accordance with IFRS.

Cash Costs per Ounce – Orla calculated cash costs per ounce by dividing the sum of operating costs, royalty costs, production taxes, refining and shipping costs, net of by-product silver credits, by payable gold ounces. While there is no standardized meaning of the measure across the industry, Orla believes that this measure will be useful to external users in assessing operating performance.

All-In Sustaining Costs (“AISC”) – Orla has disclosed an AISC performance measure that reflects all of the expenditures that are required to produce an ounce of gold from operations. While there is no standardized meaning of the measure across the industry, Orla’s definition conforms to the all-in sustaining cost definition as set out by the World Gold Council in its guidance dated 27 June 2013. Orla believes that this measure will be useful to external users in assessing operating performance and the ability to generate free cash flow from current operations.

1.14 Economic Analysis

Based on the estimated production schedule, capital costs and operating costs, a cash flow model was prepared by KCA for the economic analysis of the Camino Rojo Project. All of the information used in this economic evaluation has been taken from work completed by KCA and other consultants working on this Project.

The project economics were evaluated using a discounted cash flow (DCF) method, which measures the Net Present Value (NPV) of future cash flow streams. Construction activities for the Camino Rojo Project are currently in progress as of the date of this Technical Report. All costs related to project development are included in the pre-production capital estimate, including those already spent to date. Capital already spent has been included in the Year-1 totals but is not discounted. This provides the best estimate of the project NPV and IRR as of the date of this Technical Report.

The final economic model was based on the following assumptions:

- The mine production schedule from IMC.

- Period of analysis of fifteen years including one years of investment and pre-production, 11 years of production and three years for reclamation and closure.
- Gold price of US\$1,600/oz.
- Silver price of US\$20/oz.
- Processing rate of 18,000 tpd.
- Overall recoveries of 62% for gold and 20% for silver.
- An exchange rate of 19.3 MXN\$ to US\$ 1
- Capital and operating costs as developed in Section 21.0 of this Technical Report.

The Project economics based on these criteria from the cash flow model are summarized in Table 1-6.

**Table 1-6
Economic Analysis Summary**

Production Data		
Life of Mine	10.4	Years
Mine Throughput per day	18,000	Tonnes Ore /day
Mine Throughput per year	6,570,000	Tonnes Ore /year
Total Tonnes to Crusher	67,363,000	Tonnes Ore
Grade Au (Avg.)	0.73	g/t
Grade Ag (Avg.)	14.55	g/t
Contained Au oz	1,588,000	Ounces
Contained Ag oz	31,506,000	Ounces
Metallurgical Recovery Au (Overall)	62%	
Metallurgical Recovery Ag (Overall)	20%	
Average Annual Gold Production	94,000	Ounces
Average Annual Silver Production	597,000	Ounces
Total Gold Produced	980,000	Ounces
Total Silver Produced	6,189,000	Ounces
LOM Strip Ratio (W:O)	0.92	
Operating Costs (Average LOM)		
Mining (including pre-production tonnes)	\$1.75	/Tonne mined
Mining (processed)	\$3.37	/Tonne Ore processed
Processing & Support	\$3.20	/Tonne Ore processed
G&A	\$1.60	/Tonne Ore processed
Total Operating Cost	\$8.17	/Tonne Ore processed
Total By-Product Cash Cost	\$490	/Ounce Au
All-in Sustaining Cost	\$543	/Ounce Au
Capital Costs (Excluding IVA and Closure)		
Initial Capital	\$134	million
LOM Sustaining Capital	\$24	million
Total LOM Capital	\$158	million
Working Capital & Initial Fills	\$10	million
Closure Costs	\$29	million
Financial Analysis		
Gold Price Assumption	\$1,600	/Ounce
Silver Price Assumption	\$20	/Ounce
Average Annual Cashflow (Pre-Tax)	\$106	million
Average Annual Cashflow (After-Tax)	\$79	million
Internal Rate of Return (IRR), Pre-Tax	82%	
Internal Rate of Return (IRR), After-Tax	62%	
NPV @ 5% (Pre-Tax)	\$668	million
NPV @ 5% (After-Tax)	\$452	million
Pay-Back Period (Years based on After-Tax)	1.5	Years

A sensitivity analysis was performed on the project economics. Figure 1.1 and Figure 1.2 are charts showing the relative sensitivity to a number of parameters.

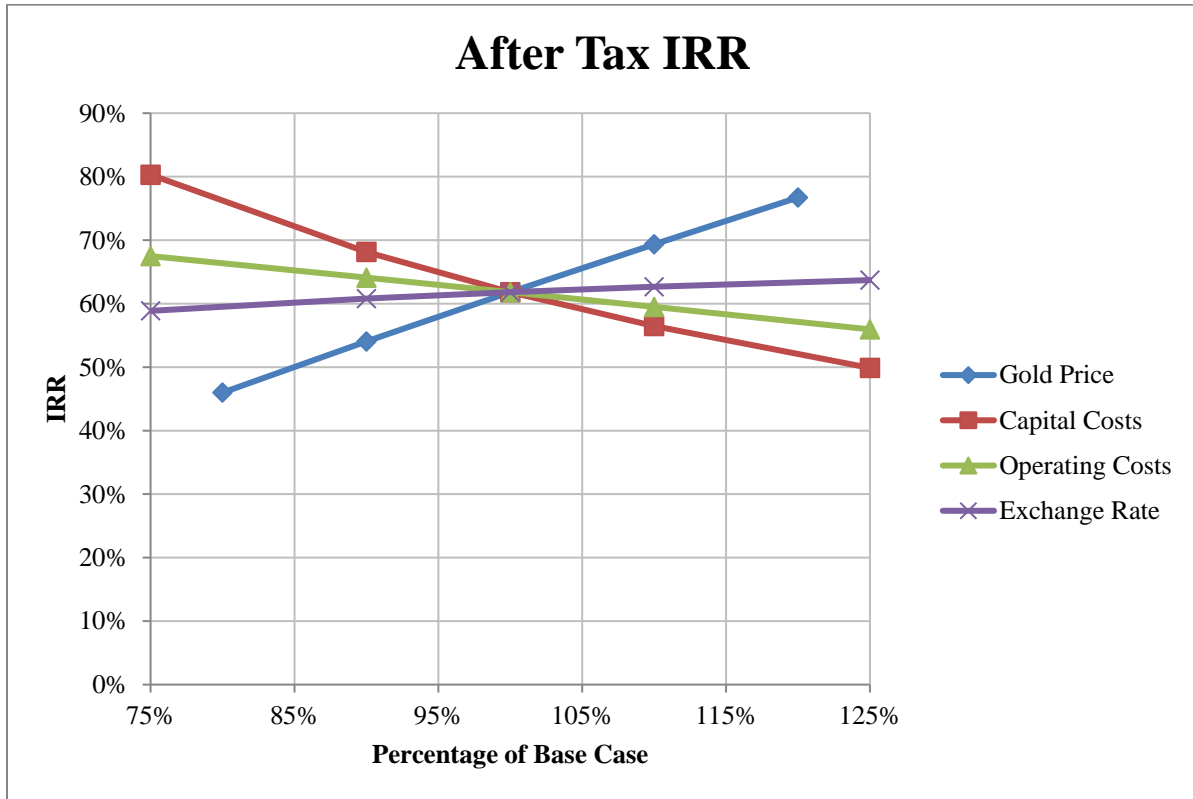

Figure 1.1 After-Tax IRR vs. Gold Price, Capital Cost, Operating Cost & Exchange Rate

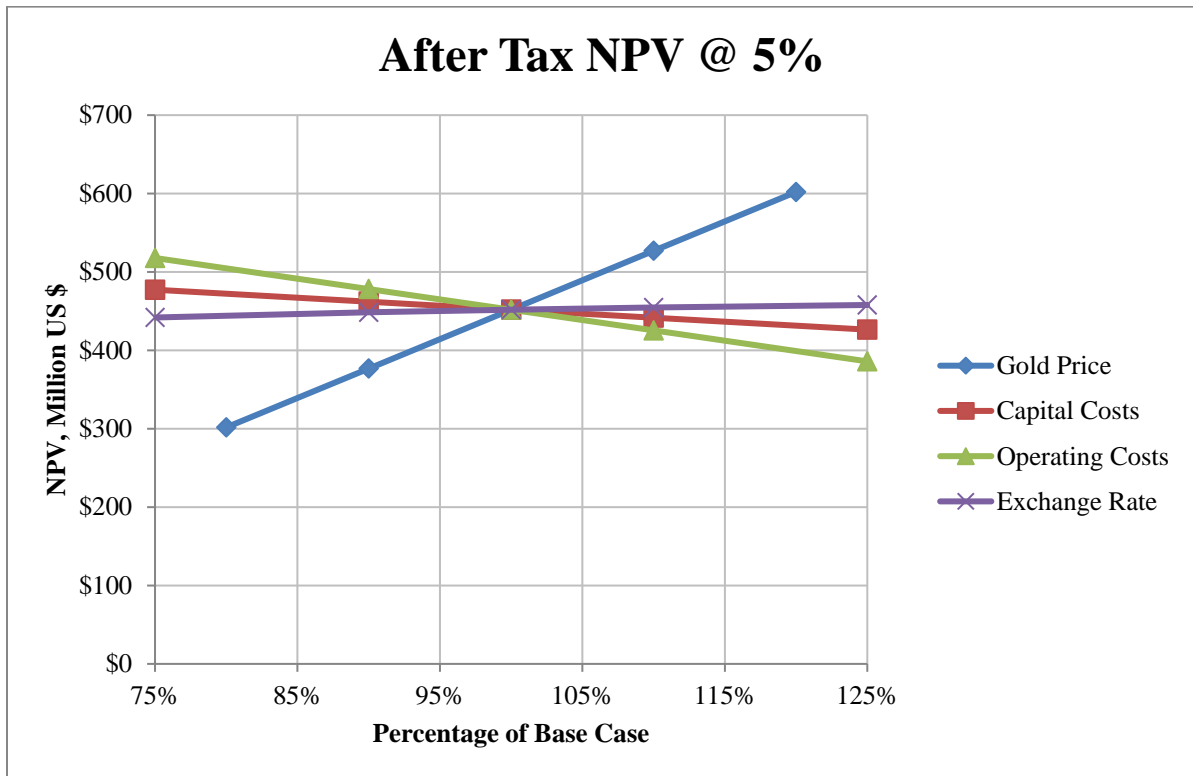

Figure 1.2 NPV @ 5% vs. Gold Price, Capital Cost, Operating Cost & Exchange Rate

1.15 Interpretations and Conclusions

1.15.1 Conclusions

The Camino Rojo open pit mine and heap leach facility described in the 2019 Technical Report is currently under construction and the site work and feasibility investigations that have been completed to date demonstrate that the Project described in this Technical Report is a technically feasible and economically viable endeavor. The property is conveniently located with access via Mexican highway 54 which connects the major cities of Zacatecas and Saltillo. The project terrain is predominately flat with sufficient water for operations available from wells located at the project site. Required mineral, surface and water rights for the project described in the 2019 Technical Report have been secured. The Layback Agreement with Fresnillo, subject to approval by COFECE, and the subsequent transfer of surface rights, provide the additional mineral and surface rights required for the expanded project described in this Technical Report. Approval by COFECE is expected to be received in a timely manner.

The Project has been designed as an open-pit mine with heap leach for recovery of gold and silver from oxide and transition material with a LOM production of 67.4 million tonnes with an average grade of 0.73 g/t Au and 14.5 g/t Ag which amounts to 1.59 million contained ounces of gold and 31.5 million contained ounces of silver. Metallurgical test work on the material to date shows acceptable recoveries for gold and silver with low to moderate reagent consumptions. Cement agglomeration is not required for stability or permeability for heap heights up to 80 metres.

Ore will be crushed to P₈₀ 28mm, stockpiled, reclaimed and conveyor stacked onto the heap leach pad at an average rate of 18,000 tpd. Stacked material will be leached using low grade sodium cyanide solution and the resulting pregnant leach solution will be processed in a Merrill-Crowe plant for the recovery of gold and silver by zinc cementation followed by drying and smelting to produce the final doré product. The Project has an estimated mine life of 10.4 years.

1.15.2 Opportunities

Key opportunities for the Camino Rojo project include:

- As part of the Layback Agreement with Fresnillo, Orla has the right to mine and recover all heap leachable material located on the adjacent concession in a pit mined for oxide and transitional material that is covered by the Layback Agreement. Any oxide or transitional material amenable to heap leach recovery would allow additional gold and silver production to Orla's account. Fresnillo drilled approximately 63 core holes totaling 33,253 metres and targeting both near surface oxide mineralization and deep sulphide mineralization in the surface area covered by the Layback Agreement. Orla has received the drill data from Fresnillo but has not yet independently verified the results or undertaken

any QA/QC analysis. However, results from holes drilled in close proximity to the most northern holes on the Orla property appear to be consistent with projections of the geological and oxidation models created from Orla's data and assay results appear to be consistent with projections of Orla's Mineral Resource model.

- In addition to the leachable oxide Mineral Resource, this Technical Report has identified Measured and Indicated Mineral Resources of 258.8 million tonnes at 0.88 g/t gold and 7.4 g/t silver that is sulphide and amenable to mill processing and flotation concentration. This amounts to 7.3 million contained ounces of gold and 61.6 million contained ounces of silver. Additional metallurgical, mining, process, environmental and other studies are required to further evaluate potential economic parameters for this material. This Mineral Resource is contained on Orla property, but was not included in this Technical Report. An additional agreement with Fresnillo will be required to exploit this Mineral Resource by open pit methods as the current Layback Agreement only covers a portion of the Mineral Resource amenable to heap leaching.
- Leaching cycles have been designed for 80 days, but laboratory results have shown that silver recoveries benefit from cyanide solution application beyond the 80-day period. With subsequent lifts, drain down from active lifts will result in extended leaching times on previously leached lifts. As a result of this, silver recoveries are expected to increase over the LOM of the Project.
- Preliminary oxidative treatment test work was conducted by KCA in 2020 and consisted of an alkaline atmospheric oxidation (AAO) process as a pre-treatment for heap leach material. This test work concluded that there is an opportunity to increase recoveries on transition and mixed sulfide material when heap leaching with a sodium cyanide solution.
- The Camino Rojo deposit occurs within a mineralized district that is highly prospective for discovery of additional deposits. New discoveries of Mineral Resources in the vicinity of the proposed mine may be accretive to the Project.

1.15.3 Risks

1.15.3.1 Mining

- Camino Rojo considers contract mining. There is a risk that the selected mining contractor may require financial assistance from the owner, which may increase costs. Contract mining is common in Mexico and this risk can be minimized by careful evaluation of potential contractors.

- By Year 5 of commercial operations the pit depths will be below the pre-mining water table and dewatering operations are anticipated. Cost estimates of these operations have been based on an expected range of dewatering rates provided in Ward (2020). Dewatering requirements outside of this range are possible due to the inherent inability to completely describe groundwater conditions in advance of mining. There is a risk that the estimated pit dewatering costs may change as a result of changed dewatering requirements.

1.15.3.2 *Metallurgy and Process*

- Carbonaceous material with preg-robbing characteristics has been identified, which may reduce overall heap performance and metal recovery if processed. With regard to gold and silver recovery the Camino Rojo deposit shows preg-robbing organic carbon as being the only significant deleterious element identified, which is primarily associated with the transition material at depth along the outer edges of the deposit. Preg robbing presents a low risk to the overall Project. A significant investigation by Orla into the preg robbing material which was reviewed by KCA indicates that preg robbing material will most likely not be encountered until later in the Project life and can be mitigated by proper ore control.
- There is a risk that Merrill-Crowe efficiencies may be poor, particularly during initial operations due to low pregnant solution concentrations of gold and silver. This may result in increased zinc consumption and delayed metal recoveries.
- Evaporators for pit dewatering require a minimum operating depth in the pond for operation which is assumed to be approximately 1.5 metres, or approximately 46,500 m³ of solution. Based on the pond sizing criteria there is sufficient capacity in the event pond to accommodate this additional solution for the planned heap without any changes. However, evaporation rates of water from the pit may not consistently be as estimated which may lead to some periodic short-term loss of pond storage.

1.15.3.3 *Access, Title and Permitting*

- The Project is subject to normal risks regarding access, title, permitting, and security. The Project has had a productive relationship with the surface owners and no extraordinary risks to project access were discerned. Conditional upon continued compliance with annual requirements, no risk to validity of title was discerned. Conditional upon compliance with applicable regulations, permits for normal exploration activities, mine construction, and mine operation are expected to be attainable. Drug related violence, propagated by members of criminal cartels and directed against other members of criminal cartels, has occurred in the region and has affected local communities. The aggression is not directed at mining companies operating in the region and has not affected the ability of Orla or previous operators to explore the Camino Rojo property.

- The Project is subject to similar risks as comparable projects; however, Orla believes it has mitigated many of those risks by early engagement with the stakeholders involved in the project, including government permitting agencies, local land holders, including the Ejidos and Fresnillo, and the advanced stage of activities around mine construction and long-lead time mine equipment. Purchase and construction of required process and other infrastructure is already underway under the plan outlined in the 2019 Technical Report. Permits for the Project currently being built were received and the expanded Project requires comparatively minor permit additions and amendments. Construction and operation of the permitted portion of the Project can continue unaffected as additional permitting requirements are met. Completion of the Layback Agreement remains subject to COFECE approval. The Feasibility Study detailed herein assumes receipt of COFECE approval and subsequent transfer of surface rights.
- In recent years, some mining projects in Mexico have suffered development delays or production stoppages as a result of community interference. Orla has an active community relations and social program and strives to maintain constructive relationships with local communities. Management believes that maintaining a robust community relations program can reduce and mitigate social risks and improve overall operational sustainability.
- Under Mexico's current COVID-19 legislation, mining and construction are permitted economic activities and the Camino Rojo Project site is operating in compliance with the Mexican Health Authority and Company requirements. Orla has implemented a strict COVID-19 protocol, including rigorous screening and testing programs to support the health of Orla's employees and local communities. The Company is closely monitoring the potential impacts from the pandemic on areas including equipment delivery and logistics, materials for construction and operation, other necessities, as well as construction costs and schedule, and community and government relations. While some delays to construction and permit amendments may occur due to the COVID-19 pandemic, Orla has taken steps to minimize potential impacts to the overall Project including additional costs related to COVID-19 safety measures.
- Federal environmental authorities issued a Change of Land Use Permit for the Camino Rojo Project on 6 February 2020, allowing mine development and operation affecting 816.25 ha. as per the Project described in the 2019 Technical Report. Receipt of the CUS permit minimizes the risk of a possible Federal designation of a protected biological-ecological reserve that could affect the project. On 24 June 2014, SEMARNAT published a public notice in the Official Gazette of the Federation requesting public consultation and comments on the possible designation of an area known as "Zacatecas Semiarid Desert"

as a Natural Protected Area (“ANP”). The proposed area for designation is located in the Municipalities of General Francisco Murguía, Villa de Cos, El Salvador, Melchor Ocampo, Concepción del Oro and Mazapil, in the State of Zacatecas (CONANP, 2014). The proposal for the ANP was created by the Comisión Nacional de Áreas Naturales Protegidas (CONANP). CONANP does not have legal authority to designate the ANP, this power being reserved for the Executive branch of Mexican Federal government. If a designation of this ANP by the government includes the surface of the mining concession areas or immediately adjacent areas, this could limit the growth and continuity of the project. However, since the time that the proposal to create this ANP was first published in the Official Gazette of the Federation, there has been no formal Federal movement on the proposal and State and municipal governments affected by the Camino Rojo Project have formally expressed opposition to creation of an ANP in the area of the Camino Rojo Project. The authors of the Camino Rojo Report believe that the permitting risk for the project is similar to that of any mining project of similar scope in North America.

1.15.3.4 *Other Risks*

- The primary Project production well (PW-1) underwent a 10,000-minute pumping test and a sustained flow of 32 L/s was maintained. There is a risk, however, that the long-term productive capacity of well PW-1 will not be maintained due to the nature of fracture- or solution-enhanced secondary permeability, and that the yield of the well may diminish. Development of additional production capacity, as recommended, will mitigate this risk.
- An ecological tax implemented by the state Congress of Zacatecas in 2017 could have a significant impact on the economics of the Project. This tax is applied to cubic metres of material extracted during mining, square metres of material impacted by dangerous substances, tonnes of carbon dioxide produced during mining processes and tonnes of waste stored in landfills. Due to the uncertainty of application of this tax and turbulence between active mining companies and the State of Zacatecas, the long-term effects and implementation of this ecological tax are currently unknown and are not considered in this Technical Report.
- The Feasibility Study and the Camino Rojo Project may be subject to legal, political, environmental or other risks that could materially affect the development of the Camino Rojo Project which are unknown at this time but could materialize in the future.

1.16 Recommendations

1.16.1 KCA Recommendations

This Technical Report presents an economically robust project. Based on these results, the following future work is recommended by KCA:

- The oxidative metallurgical test work should continue to be advanced in order to gain a better understanding of the metallurgical parameters involved in the application of oxidation processes and improved recoveries on transition and mixed sulphide material at the Project. Estimated costs for this are approximately US\$100,000.

1.16.2 RGI Recommendations

RGI recommends a phased exploration program. Phase 1, at a total cost of US\$3.7 million, consists of:

- An estimated 2,500 metres of drilling and detailed QA/QC on the Fresnillo data, and integration of Orla's geological and resource models with Fresnillo's drill data to enable material on the Fresnillo mineral concession to be included in the Measured and Indicated Mineral Resource category, which will then allow the material to be considered in an updated Reserve estimate.
- 950 line-km of induced polarization (IP) geophysical surveys to seek additional mineralized zones concealed by colluvium.
- 7,500m of RAB drilling to seek additional mineralized zones concealed by colluvium.
- A 5,000m core drill program to evaluate the sulphide resource underlying and adjacent to the oxide and transition mineralization that is the focus of this Technical Report.
- A 5,000m RC drill program to test IP anomalies already identified.

Phase 2, at a total cost of US\$1.8 million, is conditional upon identification of new IP anomalies and RAB geochemical anomalies identified in Phase 1 and comprises:

- A 5,000m RC drill program to test newly identified IP anomalies.
- A 5,000m core drilling program to evaluate the mineralized zones thus discovered.

1.16.3 John Ward, CPG, Groundwater Consultant Recommendations

John Ward, Groundwater Consultant, recommends the following:

- Construction of one or more back-up production wells capable of providing water for mine use in case the primary production well (PW-1) is out of service or cannot provide sufficient water.
- Completion of the monitoring well network.
- Estimated costs are US\$350,000 for a backup production well, and US\$375,000 for the monitoring well network.

These estimates are included in the pre-production capital costs (Table 21-3).

2.0 INTRODUCTION

2.1 Introduction and Overview

This Technical Report is an update of a previously completed Technical Report and Feasibility Study on the Camino Rojo Project and has been prepared in accordance with disclosure and reporting requirements set forth in the Canadian Securities Administrators' current "Standards of Disclosure for Mineral Projects" under the provisions of National Instrument 43-101 (NI 43-101), Companion Policy 43-101 CP and Form 43-101F1 and supersedes a Technical Report prepared by KCA dated 25 June 2019, "Feasibility Study NI 43-101 Technical Report on the Camino Rojo Gold Project Municipality of Mazapil, Zacatecas, Mexico".

This Technical Report incorporates the impact of completion of the Layback Agreement with Fresnillo, which provides Orla with the right to expand the north wall of the proposed open pit to extend across the north boundary of Orla's property. This Technical Report also reflects that the project outlined in the 2019 Technical Report has been permitted, detailed engineering is over 90% completed and construction activities are in progress.

This Technical Report is issued to Orla. Orla is listed on the TSX Exchange (TSX: OLA) and the NYSE American (NYSE: ORLA) and holds a 100% interest in the Camino Rojo deposit through its Mexican subsidiary MCR. This Technical Report was prepared by KCA, IMC, RGI and Ward with input from other consultant groups.

The Feasibility Study commenced during December 2019 and was completed during January 2021.

2.2 Project Scope and Terms of Reference

2.2.1 Scope of Work

Orla commissioned KCA to evaluate the Camino Rojo Project to Feasibility Study standards. This Technical Report is led by KCA and incorporates work from other groups including IMC for mine development and costs, RGI for the property descriptions and geology, Ward for evaluation of water supply wells, groundwater simulations of pit dewatering and simulations of off-site groundwater impacts; HydroGeoLogica Inc. (HydroGeoLogica) for heap leach pad and waste dump runoff models and Piteau Associates (Piteau) for geotechnical investigations and Barranca Group (Barranca) for hydrogeological consulting. A more detailed scope description for each group is included below.

KCA's scope of work for the project is summarized as follows:

- Review of new and historical metallurgical tests and interpretation,
- Process design and recovery methods,
- Infrastructure design,
- Infrastructure and process capital and operating costs,
- General and administrative (G&A) costs with input from Orla mining.
- Economic analysis, and
- Overall report preparation and compilation.

IMC's scope of work for the project is summarized as follows:

- Audit the drill hole database for the Camino Rojo deposit,
- Develop the Mineral Resource block model for the deposit,
- Estimate Mineral Resource,
- Estimate Mineral Reserve,
- Develop an operational mine plan for the open pit, and
- Mining capital and operating costs including evaluation of contract mining quotes.

RGI's scope of the work for the project is summarized as follows:

- Property description, including reporting on exploration work completed by Orla, geology and mineralization, environmental liabilities, location, access, physiography, infrastructure, claim ownership, and surface rights ownership,
- Assessment of regulatory requirements and description of the steps required to obtain construction and operating permits for the mine plan described in this Technical Report,
- Assess risks to project development related to access, title, permits, and security.

Ward's scope of work for the project is summarized as follows:

- Development of predictive groundwater model of dewatering and off-site impacts, reporting;
- Evaluation of site groundwater conditions and monitoring wells;
- Evaluation of production well performance.

HydroGeoLogica's scope of the work for the project is summarized as follows:

- Heap rinsing and drain down,
- Acid rock drainage and metal leaching potential,
- Heap and waste rock facility closure plans, and

- Pit lake model.

Piteau's scope of the work for the project is summarized as follows:

- Geotechnical investigations and analysis for the mine pit, waste rock dump and heap leach facilities.

Barranca's scope of the work for the project is summarized as follows:

- Well establishment and testing
- Hydrogeological investigation

The scope of this Technical Report also includes a study of information obtained from public documents; other literature sources cited; and cost information from public documents and recent estimates from previous studies conducted by KCA.

This Technical Report is intended to provide the project's economics and to give guidance for the implementation of the Camino Rojo project.

2.2.2 Terms of Reference

The purpose of this Technical Report is to disclose updated Mineral Reserves for the Camino Rojo property and to summarize the Feasibility Study completed on the property. This Technical Report supports information disclosed in a press release dated 11 January 2021.

The units of measure presented in this Technical Report, unless noted otherwise, are in the metric system. The currency used for all costs is presented in US Dollars (US\$ or \$), unless specified otherwise. A majority of the capital costs were estimated based on purchase orders issued and updated firm proposals during the current EPCM work (4th Quarter 2020). The remaining capital costs and a majority of the operating costs were received in the 3rd and 4th Quarters of 2019. For all major equipment packages, construction contracts and infrastructure items not covered by purchase orders or updated proposals, quotes obtained for the 2019 Technical Report were used for this Technical Report.

The economic evaluation of the Project has been conducted on a constant dollar basis (1st Quarter 2021) with a gold price of US\$1,600 per ounce and a silver price of US\$20 per ounce for the Base Case. Economic evaluation is done on a Project basis and from the point of view of a private investor, after deductions for royalties, income taxes, and various mining taxes and duties paid to the government of Mexico. An exchange ratio of 19.3 Mexican pesos = US\$1 was used for any costs converted from Mexican currency.

The total capital cost estimate excludes payments to Fresnillo as part of the Layback Agreement as they are considered property purchase payments. Pursuant to the Layback Agreement, an aggregate US\$62.8 million is payable to Fresnillo through a staged payment schedule.

2.3 Sources of Information

KCA has taken all reasonable care in producing the information contained in this Technical Report. The information, conclusions and estimates contained in this Technical Report are consistent with information available at the time of preparation, the data supplied by outside sources and assumptions, conditions and qualifications set forth in this Technical Report. The authors of this Technical Report are Carl Defilippi, Michael G. Hester, Dr. Matthew Gray and John Ward, each of whom is a Qualified Person as defined under NI 43-101.

The information in this Technical Report is not a substitute for independent professional advice before making any investment decisions. Any information in this Technical Report cannot be modified without the express written permission from KCA.

The primary sources of information used for this Technical Report are set out in Section 27, References, and include:

- The 25 June 2019 Feasibility Report titled “Project Feasibility Study on the Camino Rojo Gold Project Municipality of Mazapil, Zacatecas, Mexico” and accompanying appendices.
- The digital drillhole database. This includes work developed during the Canplats, Goldcorp and Orla tenures.
- The original assay certificates for the holes.
- Various geologic solids that were developed (interpreted) by Orla geologists.
- Various reports, including previous reports on sampling methodology, quality control and quality assurance (QA/QC), resource modeling, geotechnical and slope stability, mine planning, and economic evaluations. These were developed by Canplats, Goldcorp, and various consultants.
- Various new reports for water production and supply and site geotechnical evaluations.
- Various reports on metallurgical testing, process recovery, and mineral processing that were developed by Canplats, Goldcorp, Orla and various consultants.
- Published reports on Mexican taxes and duties.
- Contractor and supplier quotes from ongoing EPCM activities.

KCA, IMC, RGI and Ward reviewed the data and only used data that were deemed reliable for this Technical Report.

2.4 Qualified Persons and Site Visits

The processing studies, cost estimations, and financial analysis and review of current and historical metallurgical data were conducted by KCA under the auspices of Carl Defilippi, RM SME, of Reno, NV. Mr. Defilippi is an independent Qualified Person under NI 43-101 and is responsible for Sections 1.1, 1.5, 1.9, 1.10, 1.12, 1.13, 1.14, 1.15.1, 1.15.2, 1.15.3.2, 1.15.3.4, 1.16.1, 2, 3, 12.2, 12.3, 13, 17, 18, 19, 20.1.7, 21.0, 21.1, 21.1.2, 21.1.3 through 21.1.9, 21.2, 21.2.2, 21.3, 22, 24.1, 24.2, 24.3, 25.1, 25.1.2, 25.2.3, 25.3.2, 25.3.4, 26.1, 27 and 28 of the Technical Report. Mr. Defilippi visited the site on 20 and 21 of February 2018 and on 17 and 18 of January 2019. On these dates, Mr. Defilippi inspected the Project site and proposed locations for the process facilities and site infrastructure, examined drill core, and discussed geology and site conditions with Orla personnel.

Michael G. Hester, FAusIMM, Vice President and Principal Mining Engineer for IMC, is an independent Qualified Person under NI 43-101 and is responsible for Sections 1.6, 1.7, 1.8, 1.15.3.1, 10.1, 10.2, 10.3, 10.5.1, 10.6.1, 11.1, 11.2, 11.3.1, 11.3.2, 11.4.1, 12.1.1, 12.1.3, 14, 15, 16, 21.1.1, 21.2.1, 24.5, 25.1.1, 25.2.1, 25.2.2 and 25.3.1 of the Technical Report. Mr. Hester is responsible for drilling, sample analysis, security and data verification, Mineral Resource and Mineral Reserve estimates, the mine plan used for this Technical Report, and the mine capital and operating cost estimates. Mr. Hester visited the site on 20 and 21 February 2018. The purpose of the site visit was to examine site conditions, examine drill core, discuss project geology with Orla personnel, discuss the drilling database and sample and analytical procedures and to discuss previous work on the Project by Canplats and Goldcorp.

Matthew D. Gray, Ph.D., C.P.G, is an independent Qualified Person under NI 43-101 and is responsible for Sections 1.2, 1.3, 1.4, 1.11, 1.15.3.3, 1.16.2, 4, 5, 6, 7, 8, 9, 10.4, 10.5.2, 10.6.2, 11.3.3, 11.4.2, 12.1.2, 20 exclusive of 20.1.7, 23, 25.1.3, 25.2.4, 25.3.3, and 26.2 of this Technical Report, conducted field visits to the Camino Rojo Gold Project, Zacatecas, Mexico, during the period 12 to 13 December 2016 as part of Orla's due diligence review of the project, which at the time was owned and operated by Goldcorp. During his visit, Dr. Gray reviewed drill core, the geologic and resource model created by Goldcorp, assay and geologic data, and site infrastructure. In 2018, Dr. Gray visited again during the periods 19 to 22 February, 18 to 20 July, and 20 to 24 August. Additional site visits were made in 2019 in the periods 17 to 18 January and 8 to 12 April. During the 2018 and 2019 site visits, Dr. Gray: designed and implemented drill program QA QC protocols; reviewed new drill core; verified 2018 and 2019 drill data; checked the new geologic and resource model for consistency with drillhole data; met with, and reviewed the work of consultants preparing environmental baseline studies and permitting documents; met with Orla's Mexican legal counsel to discuss status of land, mineral, and water rights agreements; and reviewed the results of regional exploration programs.

John J. Ward, CPG, is an independent Qualified Person under NI 43-101, and is responsible for Sections 1.16.3, 24.4, and 26.3 of this Technical Report. Mr. Ward visited the Camino Rojo property in Zacatecas, Mexico, between November 13 and 17, 2018. The purpose of the site visit was to inspect the site, examine subsurface coring, conduct a well inventory of the property and surrounding region, and finalize work plans.

There is no affiliation between Mr. Defilippi, Mr. Hester, Dr. Gray, Mr. Ward and Orla, except that of an independent consultant / client relationship.

The effective date of the Mineral Resource estimate is 7 June 2019. The effective date of the Mineral Reserve estimate is 11 January 2021. The effective date of this Technical Report is 11 January 2021.

2.5 Frequently Used Acronyms, Abbreviations, Definitions and Units of Measure

All costs are presented in United States dollars. Units of measurement are metric. Only common and standard abbreviations were used wherever possible. A list of abbreviations used is as follows:

Distances:	mm	– millimetre
	cm	– centimetre
	m	– metre
	km	– kilometre
	mbgl	– metres below ground level
	masl	– metres above sea level
Areas:	m ² or sqm	– square metre
	ha	– hectare
	km ²	– square kilometre
Weights:	oz	– troy ounces
	Koz	– 1,000 troy ounces
	Moz	– 1,000,000 troy ounces
	g	– grams
	kg	– kilograms
	T or t	– tonne (1000 kg)
	Kt	– 1,000 tonnes
	Mt	– 1,000,000 tonnes
	Time:	min
h or hr		– hour
op hr		– operating hour
d		– day
yr		– year
Ma		– Mega-annum (one million years)
Volume/Flow:	m ³ or cu m	– cubic metre
	m ³ /h	– cubic metres per hour
	L/s	– litres per second
Assay/Grade:	g/t	– grams per tonne
	kg/t	– kilograms per tonne
	g/t Au	– grams gold per tonne
	g/t Ag	– grams silver per tonne
	ppm	– parts per million;
	ppb	– parts per billion
Other:	TPD or tpd	– metric tonnes per day

ktpy	– 1,000 tonnes per year
kph	– kilometres per hour
kV	– kilovolt
m ³ /h/m ²	– cubic metres per hour per square metre
Lph/m ²	– litres per hour per square metre
L/s/km ²	– litres per second per square kilometres
g/L	– grams per litre
Ag	– silver
As	– arsenic
Au	– gold
Ba	– barium
Hg	– mercury
Pb	– lead
Sb	– antimony
Zn	– zinc
US\$ or \$	– United States dollar
MXN\$	– Mexican Peso
NaCN	– sodium cyanide
TDS	– total dissolved solids
DDH	– diamond drill boreholes
LOM	– life of mine
RAB	– rotary air blast
ROM	– run of mine
RC	– reverse circulation
RQD	- rock quality data
Preg	– pregnant solution
kWh	– kilowatt-hours
V	– volts
kVa	– kilo-volt-ampere
TEM	– transient electromagnetic
P ₈₀	– 80% passing
P ₁₀₀	– 100% passing
KN	– kilonewton
CMU	– concrete masonry unit
HLP	– heap leach pad
TSX	– Toronto Stock Exchange
Owner	– Orla Mining LTD.
NAD27	– North American Datum of 1927 coordinates
WGS84	– World Geodetic System (1984) coordinates
AAO	– Atmospheric Alkaline Oxidation

3.0 RELIANCE ON OTHER EXPERTS

All of the work summarized above was prepared under the supervision of a Qualified Person or has been reviewed and approved by a Qualified Person. The authors would like to acknowledge those who assisted in the study as “non-Qualified Persons” and their respective inputs are listed:

Sections authored by Mr. Defilippi:

- James Hogarth and Chris Wattam, Piteau Associates, Vancouver BC (geotechnical investigations for pit slope stability, heap leach facility and waste rock dump stability) (Piteau, 2019).
- Jake Waples and Brent Johnson, HydroGeoLogica, Golden CO (heap and waste rock dump closure, pit lake model geochemistry) (HydroGeoLogica, 2020).

Sections authored by Mr. Ward:

- David Hawkins, Barranca Group, Tucson AZ (production well testing, hydrogeologic consulting) (Barranca, 2020)

The authors are not experts in Mexican legal, political, environmental or tax matters and accordingly for Items 4.2, 4.3, 4.5, and 4.6 the authors have relied upon:

- For legal matters regarding mining concession title, opinion was provided by Lic. Mauricio Heiras, Mexican legal counsel for Orla dated 28 June 2017 (Heiras, 2017) and in reports prepared by Lic. Maricio Heiras for Orla dated 6 January 2018 (Heiras, 2018), 18 June 2019 (Heiras, 2019), and January 2021 (Heiras, 2021).
- For legal matters regarding surface rights, land access agreement summaries were provided by Lic. Mauricio Heiras, Mexican legal counsel for Orla in a report dated 28 June 2017 (Heiras, 2017) and reports dated 6 January 2018 (Heiras, 2018), 18 June 2019 (Heiras, 2019), and January 2021 (Heiras, 2021).
- For legal matters on environmental permitting, reports were prepared by Lic. Mauricio Heiras, Mexican legal counsel for Orla, dated 28 June 2017 (Heiras, 2017), 18 June 2019 (Heiras, 2019), and January 2021 (Heiras, 2021).
- For environmental matters relating to the 24-hour storm event for different periods, the report prepared by NewFields Servicios de Mexico dated 1 February 2019 titled "Diseno Conceptual de Manejo de Aguas Pluviales y Control de Sedimentacion, Proyecto Minero Camino Rojo, San Tiburcio, Zacatecas, Mexico" (NewFields, 2019).
- For political matters relating to the independent assessment of social and community impacts of development of the Camino Rojo project, and to provide guidance on actions and policies needed to insure that Orla obtains and maintains social licence to operate the project, the conclusions and data contained in a report prepared by Environmental Resources Management (ERM), a global provider of environmental, health, safety, risk,

social consulting services and sustainability related services, titled “Estudio de Impacto Social para el Proyecto Minero “Camino Rojo”, Marzo 2019 Proyecto No.: 0460594” (ERM, 2019).

Except for the purposes legislated under provincial securities laws, any use of this Technical Report by any third party is at that party’s sole risk.

4.0 PROPERTY DESCRIPTION AND LOCATION

4.1 Area and Location

The Camino Rojo property is located in the Municipality of Mazapil, State of Zacatecas, Mexico near the village of San Tiburcio. The property lies 190km NE of the city of Zacatecas, 48km S-SW of the town of Concepción del Oro, and 54km S-SE of Newmont’s Peñasquito Mine (Figure 4.1). The Project area is centred at approximately 244150E 2675900N UTM NAD27 Zone 14N.

All geographic references in this Technical Report utilize UTM Zone 14N datum NAD27 unless otherwise stated.



Figure 4.1 Location Map, Camino Rojo Project

4.2 Claims and Title

The authors of this Technical Report are not experts in Mexican mining law. The authors have relied upon Orla's legal counsel in Mexico, Lic. Mauricio Heiras of Chihuahua, Chihuahua for a review of the concession titles and legal framework, as shown in Table 4-1. Lic. Heiras verified that the concessions are in good standing and ownership of all seven concessions has been registered to MCR, (Heiras, 2017), (Heiras, 2018), (Heiras, 2019), (Heiras, 2021).

All minerals rights in Mexico are the property of the government of Mexico and may be exploited by private entities under concessions granted by the Mexican federal government. The process was defined under the Mexican Mining Law of 1992 and excludes petroleum and nuclear resources from consideration. The Mexican mining law also requires that non-Mexican entities must either establish a Mexican corporation, or partner with a Mexican entity.

Under current Mexican mining law, amended 29 April 2005, the Direccion General de Minas (DGM) grants concessions for a period of 50 years, provided the concession is maintained in good standing. There is no distinction between mineral exploration and exploitation concessions. As part of the requirements to maintain a concession in good standing, bi-annual fees must be paid based upon a per-hectare escalating fee, work expenditures must be incurred in amounts determined on the basis of concession size and age, and applicable environmental regulations must be respected.

The Camino Rojo property consists of seven concessions covering in aggregate 163,129.92 hectares. All concessions were originally staked and titled to Canplats de Mexico SA de CV, whose legal name was subsequently changed to Camino Rojo SA de CV. Camino Rojo SA de CV subsequently ceded all mining claims to Minera Peñasquito SA de CV, who in turn sold the mining claims to MCR, as discussed in Section 4.2.1 of this Technical Report.

Concession information is summarized in Table 4-1, and the concessions are shown in Figure 4.2.

In addition to the claims held directly, MCR has obtained the right to mine waste rock and to mine, and recover for Orla's account, all oxide and transitional material amenable to heap leaching that is within that portion of the open pit extending onto an adjacent mineral concession, as discussed in Section 4.2.2 of this Technical Report.

**Table 4-1
Listing of Mining Concessions**

Concession Name	File Number (Expediente)	Title Number	Validity		Area
			Title Issued Date	Expiration Date	Hectares
Camino Rojo	093/28336	230914	6/11/2007	5/11/2057	8,340.79
Camino Rojo 1	093/28349	231922	16/05/2008	15/05/2058	88,897.33
Camino Rojo 1 Frac. A	093/28349	231923	16/05/2008	15/05/2058	96.89
Camino Rojo 3*	093/28425	232014	3/6/2008	2/6/2058	14,830.00
Camino Rojo 2	093/28417	232076	10/6/2008	9/6/2058	17,847.44
Camino Rojo 4	093/28465	246859	19/12/2019	1/10/2058	96.00
Camino Rojo 5**	093/28534	232647	2/10/2008	1/10/2058	33,018.47
Total					163,126.92

* originally 30,050 Has, application to reduce to 14,830 ha filed on 10 Sept 2019

** originally 154,055.02 Has, application to reduce to 33,018.47 ha filed on 11 Dec 2013

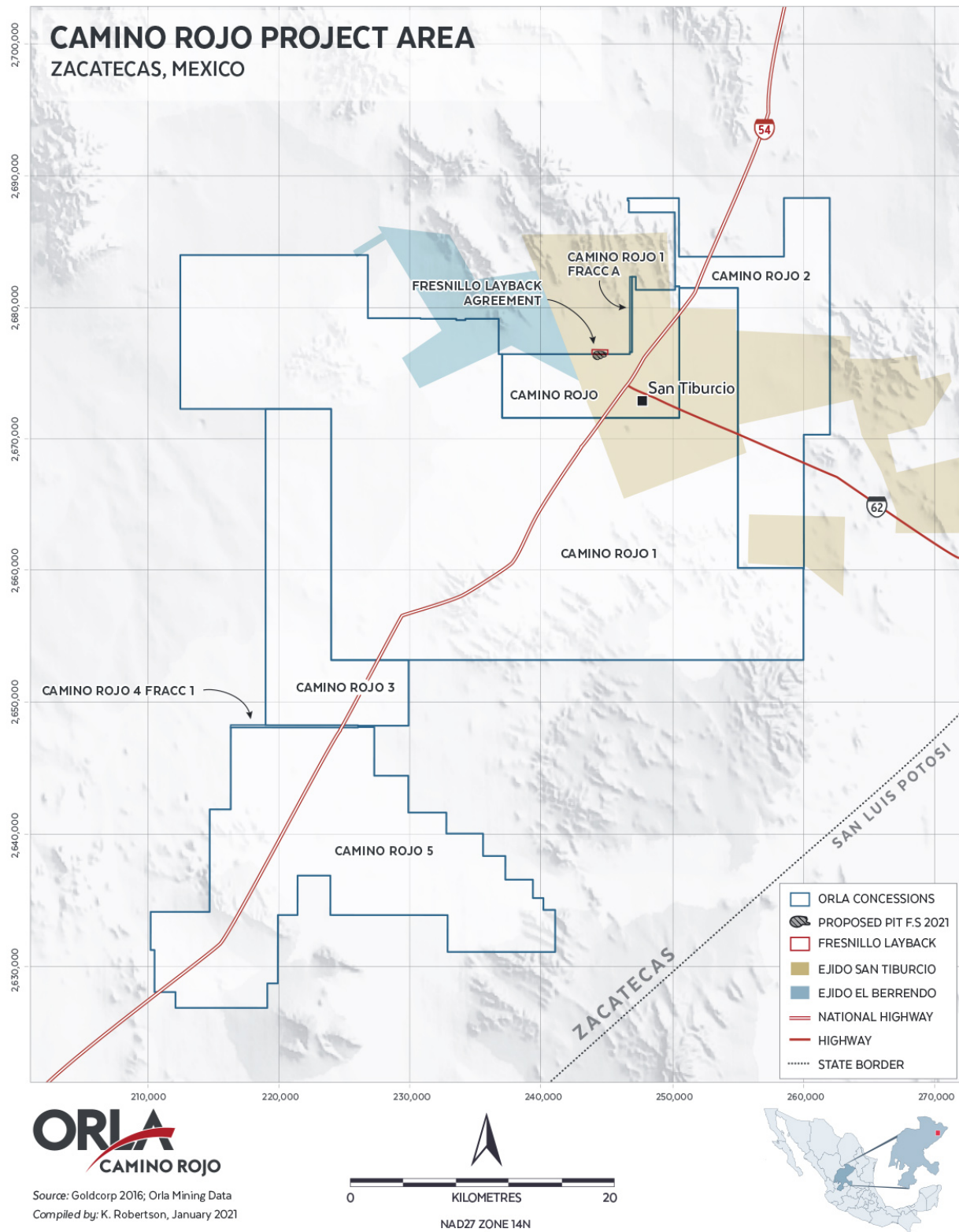

Figure 4.2 Mining Concessions, Camino Rojo Property

Prior to entering into purchase option agreements for the concessions, Orla requested a title opinion for the concessions from Orla's legal counsel in Mexico, Lic. Mauricio Heiras of Chihuahua, Chihuahua, who investigated the concession status and reported that the claims were valid. Subsequent to Orla's acquisition of the Project, and as of the effective date of this Technical Report, Lic. Heiras has confirmed that MCR has maintained the concessions in good standing and all concessions are current with respect to payment of mining taxes and filing of assessment reports (Heiras, 2019), (Heiras, 2021).

4.2.1 Orla Control of Mining Concessions via Acquisition from Minera Peñasquito SA de CV

The claims are controlled by Orla by means of its ownership of MCR, which acquired the concessions from Newmont's Mexican subsidiary, Minera Peñasquito SA de CV. A summary of Orla's and Newmont's rights and obligations under the terms of the acquisition agreement is as follows:

- Goldcorp, a subsidiary company to Newmont, was granted a 2% NSR royalty on all metal production from the Project, except for metals produced under the sulphide joint venture option stipulated in the acquisition agreement. On 29 October 2020 the 2% NSR royalty that pertains to oxide material was acquired by Maverix Metals Inc.
- Orla is the operator of the Camino Rojo Project and has full rights to explore, evaluate, and exploit the property.
- In the event that a sulphide project is defined through a positive Pre-Feasibility Study outlining one of the development scenarios a) or b) contained herein, Newmont may, at its option, enter into a joint venture for the purpose of future exploration, advancement, construction, and exploitation of the sulphide project.
 - Scenario a): A sulphide project where material from the Camino Rojo Project is processed using the existing infrastructure of the Peñasquito Mine, Mill and Concentrator facilities. In such circumstances, the sulphide project would be operated by Newmont, who would earn a 70% interest in the sulphide project, with Orla owning 30%.
 - Scenario b): A standalone sulphide project with a mine plan containing at least 500 million tonnes of Proven and Probable Mineral Reserves using standalone facilities not associated with Peñasquito. Under this scenario, the sulphide project would be operated by Newmont, who would earn a 60% interest in the sulphide project, with Orla owning 40%.
- Following exercise of its option, if Newmont elects to sell its portion of the sulphide project, in whole or in part, then Orla would retain a right of first refusal on the sale of the sulphide project.

- For as long as Newmont maintains ownership of at least 10% of Orla common shares, Newmont has the right to nominate one director to the board of Orla and to participate in all future equity offerings to maintain its prorated ownership.
- Carry forward of assessment work credits will be applied to the Camino Rojo property concessions thus no expenditures are immediately required to meet assessment work requirements.

4.2.2 Orla's Access to a Portion of Fresnillo's Mining Concessions

On December 21, 2020, Orla announced that it had entered into an agreement with Fresnillo plc and two of its Mexican subsidiary companies, granting Orla the right to expand the Camino Rojo oxide pit onto 21.8 ha. of Fresnillo's 782 ha. "Guachichil D1" mineral concession, Title 245418, located immediately to the north of Orla's property pursuant to a definitive layback agreement (the "Layback Agreement"). The Layback Agreement allows Orla access to oxide and transitional heap leachable Mineral Resources on Orla's property below the open pit outlined in the June 2019 Technical Report. In addition, the Layback Agreement grants Orla the right to mine from Fresnillo's mineral concession and recover for Orla's account, all oxide and transitional material amenable to heap leaching that are within an expanded open pit. Closing of the Layback Agreement is subject to receipt of approval from the Mexican Federal Competition Commission (Comisión Federal de Competencia Económica or "COFECE").

The Layback Agreement is only with respect to the portion of the heap leach material included in the Mineral Reserve. Any potential development of the Camino Rojo property that includes an open pit encompassing the Mill Resource included in the Mineral Resource estimate is dependent on entering into an additional agreement with Fresnillo (or any potential subsequent owner of the mineral titles).

Pursuant to the Layback Agreement, Orla will pay Fresnillo a total cash consideration of US\$62.8 million based on the following schedule:

- US\$25 million due upon the execution of the definitive Layback Agreement and approval of the Layback Agreement by COFECE;
- US\$15 million due no later than (i) twelve (12) months following the commencement of commercial production at Camino Rojo or (ii) December 1, 2022, whichever is earlier; and US\$22.8 million due no later than (i) twenty-four (24) months following the commencement of commercial production at Camino Rojo or (ii) December 1, 2023, whichever is earlier.

The amounts for the third and fourth payments shall bear an interest of 5% per annum from the date COFECE approval is granted until the date of payment.

4.2.3 Pending Concession Reductions

Currently, ongoing exploration programs are identifying the most prospective areas surrounding the Camino Rojo deposit. Prior operators and Orla, through its Mexican subsidiary MCR, have filed petitions to relinquish mineral rights to the least prospective ground, reducing project mineral concession holdings to 1,631 km² as shown in Figure 4.2 and summarized in Table 4-1. Newmont retains the right to re-acquire the mineral rights to any lands released by MCR. If Newmont does not elect to exercise its rights, the released mineral concessions will revert to Federal control.

4.3 Surface Rights

The authors of this Technical Report are not an expert in Mexican legal surface rights or contract law. The authors have relied upon Orla's legal counsel in Mexico, Lic. Mauricio Heiras of Chihuahua, Chihuahua for a review of the Project surface rights (Heiras, 2017), (Heiras, 2018), (Heiras, 2019), (Heiras, 2021) as discussed in Section 3.0 of this Technical Report.

Surface rights in the Project area are owned by several Ejidos, which are federally defined agrarian communities. The land which includes the Mineral Resource at Camino Rojo is controlled by the San Tiburcio Ejido, comprised of 400 voting members who collectively control 37,154 hectares. The legal ownership of surface rights verification and the information contained herein comes from summary reports prepared by Orla's legal counsel in Mexico, Lic. Mauricio Heiras.

Areas for which MCR controls surface rights include both areas with and without mineral rights, with the latter being maintained for possible infrastructure purposes. Surface rights controlled are shown in Figure 4.3.

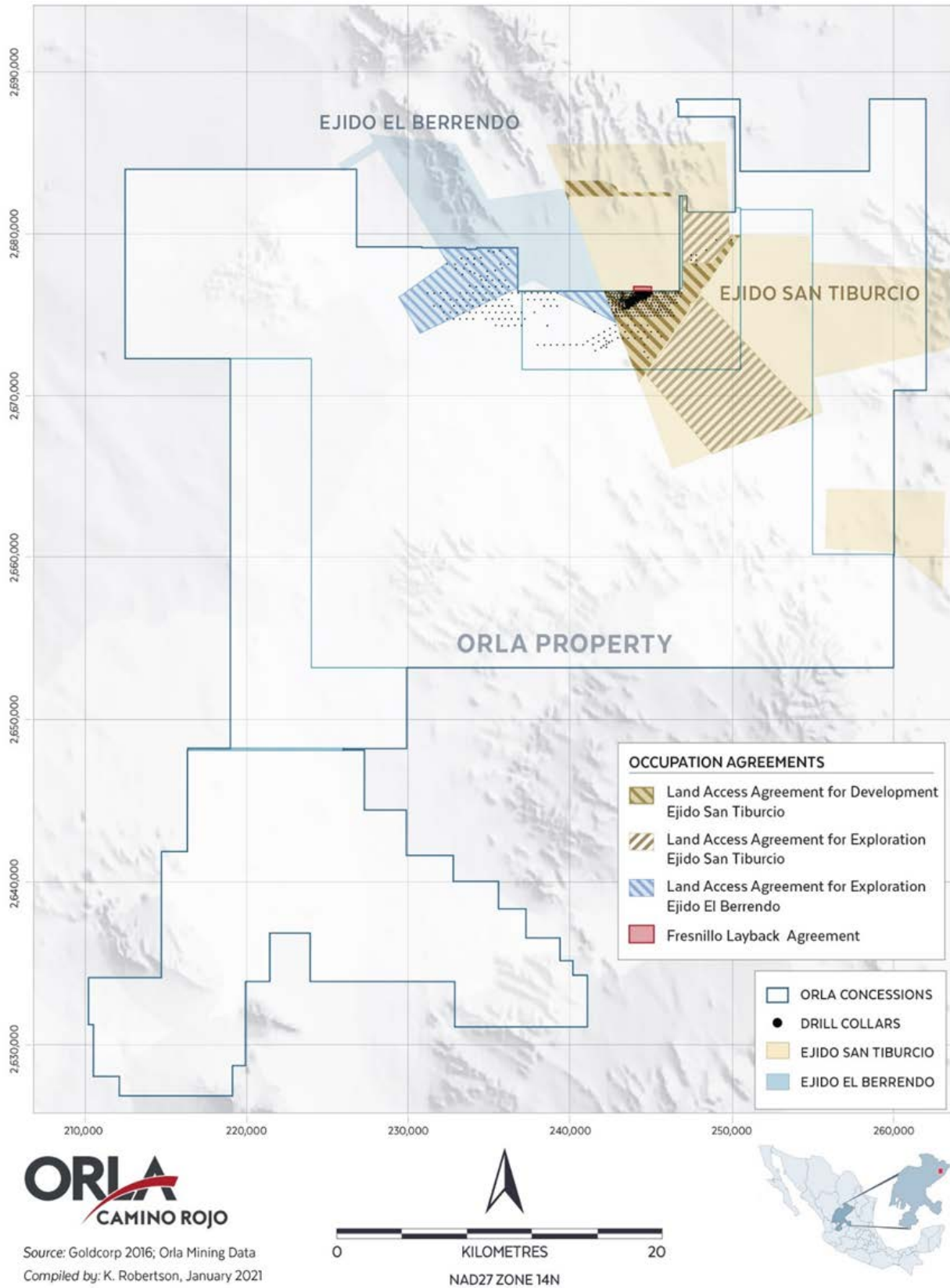

Figure 4.3 Surface rights in Project Area

Exploration work at the Project has been carried out under the terms of surface access agreements negotiated with the Ejido San Tiburcio and executed on 26 February 2013 and 31 October 2018. Camino Rojo SA de CV (a Goldcorp subsidiary) executed agreements with the Ejido that cover the Camino Rojo Mineral Resource. Camino Rojo SA de CV subsequently passed the rights and obligations of these agreements to Minera Peñasquito SA de CV (a Goldcorp subsidiary), who subsequently transferred the rights and obligations to MCR. The three agreements currently in effect with Ejido San Tiburcio are:

- Previous to Expropriation Occupation Agreement (COPE), executed on 26 February 2013 by and between Camino Rojo SA de CV, in its position of “occupant”, and Ejido San Tiburcio, as the owner, with regards to a surface of 2,497.30 ha. The rights and obligations of this agreement were passed to MCR and the agreement stipulates that the Ejido expressly and voluntarily accepts the expropriation of Ejido lands by MCR, in effect converting the Ejido land to fee simple private land titled to MCR. In the event that the Federal agency responsible for the expropriation process, the Secretario de Desarrollo Agrario Territorial y Urbano, denies the petition to cede the Ejido lands to MCR, the agreement automatically converts to a 30-year temporary occupation agreement. Payment in full was made at the date of signing and no further payments are due. This agreement is valid and expires in 2043 and covers the area of the Mineral Resource discussed in this Technical Report.
- Temporary Occupation Agreement (COT), executed on 30 October 2018 by and between MCR, in its position of occupant, and Ejido San Tiburcio, as owner, with regards to a surface of 5,850 ha. (the “TOA”). This agreement allows MCR to explore 5,850 ha. of Ejido lands over a 5-year period, while the expropriation process is executed. Payments of \$10,000,000 Pesos on signing, \$5,000,000 Pesos on 15 December 2019, \$5,000,000 Pesos on 15 December 2020, and \$5,000,000 Pesos on 15 December 2021 are required to maintain the agreement in force. MCR has made all required payments up to the date of this Technical Report, thus is current on all required payments and the agreement is in good standing (Heiras, 2021).
- Collaboration and Social Responsibility Agreement (CSRA), executed on 26 February 2013 by and between Camino Rojo SA de CV, in its position of “collaborator”, and Ejido San Tiburcio, as “beneficiary”, with regards to certain social contributions to be provided in favour of this last CSRA. The rights and obligations of this agreement were passed to MCR and the agreement stipulates that MCR will contribute \$10,000,000 Pesos annually to the Ejido to be used to promote and execute diverse social and economic development programs to benefit the Ejido. Additionally, at its discretion, MCR will provide support for adult education, career training, business development assistance, and cultural programs, and scholastic scholarships. The agreement expires when exploration or exploitation

activities at the Camino Rojo Project end. Annual payments are due on the 29th of June each year. MCR has made all required payments up to the date of this Technical Report, thus this agreement is valid and remains in effect until mine closure or project cancellation.

MCR executed a surface rights agreement with Ejido El Berrendo on 4 March 2019. None of the Mineral Resources or Mineral Reserves discussed in this Technical Report, nor proposed infrastructure, is located on Ejido El Berrendo land. This Temporary Occupation Agreement (COT) allows MCR to conduct exploration activities on 2,631 ha., as shown in Figure 4.3. The agreement expires on 24 February 2024. A payment on signing and annual payments of \$2,284,787 Pesos are required to keep the agreement in good standing. MCR has made all required payments up to the date of this Technical Report, thus is current on all required payments and the agreement is in good standing (Heiras, 2021).

Fresnillo controls surface rights needed for exploration and mining on the Guachichil D1 mining concession. Pursuant to the Layback Agreement, 27.5 hectares of surface rights controlled by Fresnillo will be acquired by MCR to mine on a portion of the Guachichil D1 mining concession that covers the area outside of the Orla concession required for the project as defined in this Technical Report.

4.4 Environmental Liability

No environmental liabilities are apparent. Prior to Orla's development of the Project, the property did not contain active or historic mines or prospects, and there were no pre-existing plant facilities nor tailings piles present within the Project area. All exploration work has been carried out by prior operators in accordance with Mexican environmental standards.

MCR currently has all major permits required for construction and operation of the Project described in the 2019 Technical Report. There are no impediments to construction, mining, and processing activities for the already authorized project while permit modifications for the project described in this Technical Report are in the application process. MCR commenced the start of earthworks on 26 November 2020 and through January 2021, 230 hectares had been cleared for construction activities with over 20,000 cubic metres of topsoil removed and stockpiled. A total of 3,703 plants were rescued as part of flora and fauna relocation, and as of January 2021 the 44-kilometre, 34.5-kV powerline is 49% complete. Equipment deliveries to site commenced in December 2020.

4.5 Permits

The authors of this Technical Report are not experts in Mexican environmental law. The authors have relied upon Orla's legal counsel in Mexico, Lic. Mauricio Heiras of Chihuahua, Chihuahua for a summary review of the Project environmental permits (Heiras, Legal opinion letter, 2017), (Heiras, 2019), (Heiras, 2021) and a public domain Federal report (CONANP, 2014) for a review of permitting risks discussed in this Technical Report.

The Ley de Desarrollo Forestal Sustentable (Sustainable Development Forest Law) and the Ley General del Equilibrio Ecológico y Protección al Ambiente (General Law of Ecologic Equilibrium and Environmental Protection) regulate all direct exploration activities carried out at Camino Rojo (reverse circulation drilling, core drilling, trenching, road construction, etc.). Surface disturbances caused by exploration activities require a Cambio de Uso de Suelo (CUS, Land Use Change) authorization and approval of an Manifiesto de Impacto Ambiental (MIA, Environmental Impact Statement).

The National Water Law regulates all water use in Mexico under the responsibility of Comisión Nacional del Agua (CONAGUA). Applications are submitted to CONAGUA indicating the annual water needs for mining activities and the source of water to be used. CONAGUA grants water concessions according to stipulated water availability in the source area. MCR is the title holder of subsurface water rights totaling 9,695,900 cubic metres per annum for industrial use (Heiras, 2021).

Current exploration work at the Project is being conducted under the approval of MIA and CUS permits. Construction and operation of the open pit mine described in the 2019 Technical Report has been approved by SEMARNAT under the authorization of CUS and MIA permits issued in February and August 2020 respectively.

On 30 August 2019 MCR submitted to SEMARNAT an application for a CUS permit for the construction and operation of an open pit mine as per the project described in the 2019 Technical Report. Federal environmental authorities approved this CUS permit in December 2019, MCR made the requisite payment to the National Forestry Commission (Comision Nacional Forestal) on 23 January 2020, and MCR received the CUS permit on 6 February 2020, via Oficio No. DFZ152-201/20/0196 allowing the mine development and operation affecting 816.25 ha. The project described in this Technical Report will require an additional CUS permit to allow for additional surface disturbances related to development of a pit layback onto lands not considered in the August 2019 permit application. The additional CUS permit is expected to require 3 months for preparation of the application, and an additional 6 months for review and issuance of resolution by SEMARNAT.

On 29 August 2019 Minera Camino Rojo submitted to SEMARNAT the MIA (Manifiesto de Impacto Ambiental/Environmental Impact Statement) for the construction and operation of an open pit mine as per the project described in the 2019 Technical Report. MCR received the MIA permit on 11 August 2020, via Oficio No. SGPA/DGIRA/DG/03478, authorizing mine construction and operation of the project described in the 2019 Technical Report. The Project described in this Technical Report, at the discretion of SEMARNAT, may require a modification to the MIA permit, or an additional MIA permit to allow for additional production related to development of a pit layback onto lands not considered in the August 2019 permit application. Process methods and process infrastructure does not change. The MIA modification or additional MIA permit request is expected to require 3 months for preparation of the application, and an additional 6 months for review and issuance of resolution by SEMARNAT.

Federal regulations require staged postings of a bond or financial guarantee for the estimated cost of reclamation, proportional to the pending reclamation work created by the Project in each development phase, as determined by a Technical Economic Study. On 11 November 2020 MCR submitted the required first stage reclamation bond of \$89,451,775 Pesos (~ \$4.5 M) which was accepted by the Federal Treasury, with formal notice given to PROFEPA, on 13 November 2020. All MIA and CUS permit conditions have been satisfied, allowing for site activities to commence for the Project described in the 2019 Technical Report.

MCR received a Municipal Construction Licence on 4 December 2020 from the Mazapil Municipality, authorizing construction of the mine and processing infrastructure as per the Project described in the 2019 Technical Report. The Project described in this Technical Report will require a modification to the Municipal Construction License to allow for additional earthworks related to development of a pit layback onto lands not considered in the August 2019 permit application.

MCR currently has all major permits required for construction and operation of the project described in the 2019 Technical Report. Certain permits, including authorization from SEDENA to use and store explosives, cannot be obtained before facilities are built, and routine surface water management permits from CONAGUA, required for constructing surface drainage diversion works and road crossings, are in process. Receipt of these permits is not expected to affect project timelines. There are no impediments to construction, mining, and processing activities for the already authorized project while permit modifications for the project described in this Technical Report are in the application process.

Construction and operation of the mine described in this Technical Report will require various Federal, State, and Municipal permits as discussed in Section 20.2 of this Technical Report.

4.6 Access, Title, Permit and Security Risks

4.6.1 Access Risks

The Project has had a productive relationship with the surface owners and no extraordinary risks to Project access were discerned. A valid surface access agreement allows Orla, through its Mexican subsidiary MCR, to explore and develop the Project described in the 2019 Technical Report. Development of the Project as described in this updated Feasibility Study will require transference to MCR of the surface access rights currently held by Fresnillo subject to the Layback Agreement summarized in Section 4.3 of this Technical Report. The Layback Agreement is subject to COFECE approval.

4.6.2 Title Risks

Prior operators and Minera Camino Rojo have met legal requirements to maintain in good standing the mining concession titles. Conditional upon continued compliance with annual requirements, no risk to validity of title was discerned.

4.6.3 Permit Risks

Prior operators and Minera Camino Rojo have been compliant with Mexican environmental regulations and conditional upon continued compliance, permits for normal exploration activities are expected to be readily attainable.

Approximately two-thirds of the Mineral Reserves described in this Technical Report are within the currently permitted mine plan. The remaining portion will require additional permits for an expanded pit and approval of the Layback Agreement from COFECE. These permits are expected to be approved in a reasonable timeline. The authors of the Camino Rojo Report believe that the permitting risk for the project is similar to that of any mining project of similar scope in North America.

4.6.4 Security Risks

Drug related violence, propagated by members of criminal cartels and directed against other members of criminal cartels, has occurred in the region and has affected local communities. The aggression is not directed at mining companies operating in the region and has not affected the ability of Orla or previous operators to explore the Camino Rojo Project.

4.7 Royalties

Under the terms of the acquisition agreement, Newmont acquired a 2% NSR royalty on all metal production from the Camino Rojo Project, except for metals produced under a sulphide joint

venture option as stipulated in the acquisition agreement. On 29 October 2020 the 2% NSR royalty that pertains to the oxide material was acquired by Maverix Metals Inc.

A 0.5% royalty is payable to the Mexican government as an Extraordinary Mining Duty, mandated by Federal Law, and applies to precious metal production from all mining concessions, regardless of owner or other royalty encumbrances.

5.0 ACCESSIBILITY, CLIMATE, LOCAL RESOURCES, AND PHYSIOGRAPHY

5.1 Accessibility

The Camino Rojo project is located in the Municipality of Mazapil, State of Zacatecas, Mexico, situated along a wide, flat valley near the village of San Tiburcio on Mexican Highway 54, a well-maintained, paved highway providing southbound access to the major city of Zacatecas in Zacatecas State, a distance of 203km, as well as northbound towards Monterrey in Nuevo Leon, a distance of 261km (Figure 5.1). Both of these cities have airports with regularly scheduled flights south to Mexico City or north to the U.S.A. The Project is located 48 km S-SW of the nearest population center with basic services, the town of Concepción del Oro, and 54 km S-SE of Newmont's Peñasquito Mine.

There are numerous gravel roads within the property linking the surrounding countryside with the two highways, Highways 54 and 62, which transect the property. There are very few locations within the property that are not readily accessible by four-wheel drive vehicle.

The project area is centered at approximately 244150E 2675900N UTM NAD27 Zone 14N.

All geographic references in this Technical Report utilize UTM Zone 14N datum NAD27 unless otherwise stated.

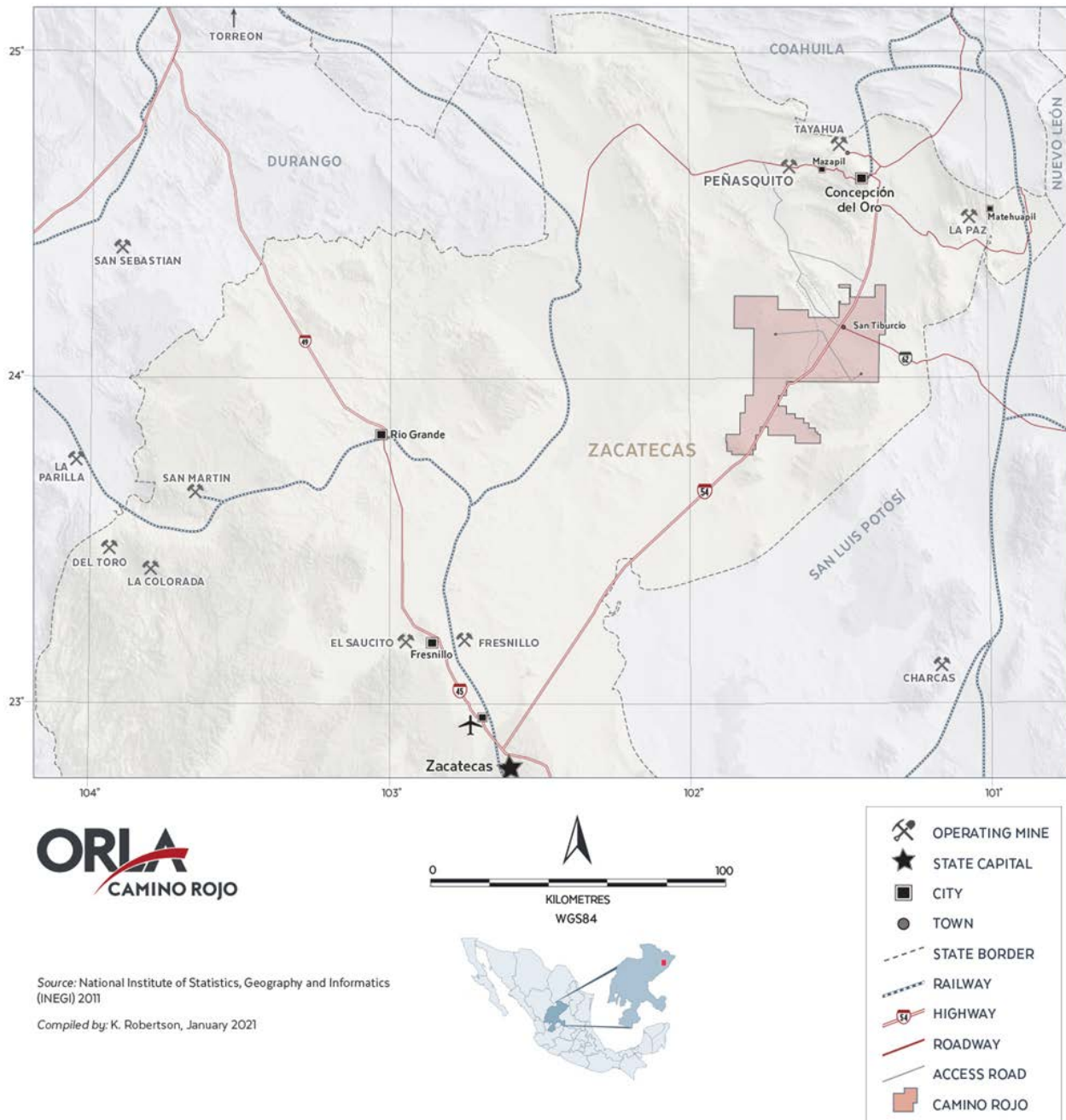

Figure 5.1 Project Location and Regional Infrastructure

5.2 Physiography, Climate and Vegetation

The broad valley around San Tiburcio is bounded to the north by the low rolling hills of Sierra La Arracada and Sierra El Barros, to the east by Sierra La Cucaracha, and to the south by the Sierra Los Colgados. The terrain is generally flat. Bedrock exposures are rare, limited to road cuts,

borrow pits or creek beds. The elevations within the property range from approximately 1,850 to 2,460 masl and relief is low.

The climate is typical of the high-altitude Mesa Central, dry and semi-arid. Annual precipitation for the area is approximately 337mm, mostly during the rainy season in July, August, and September. Temperatures commonly range from +30° to 12°C in the summer and 24° to -6°C in the winter. Exploration and production activities can be conducted year-round.

The vegetation is dominated by the scrub bushes creosote bush and tar bush, with lesser cacti, maguey, sage and coarse grasses with rare yucca (Figure 5.2). The natural vegetation is used to locally graze domestic livestock, principally goats. Wild fauna is not abundant but several varieties of birds, rabbits, coyote, lizards, and snakes inhabit the area.



Figure 5.2 View of Typical Topography and Vegetation at Camino Rojo

5.3 Local Resources and Infrastructure

There is a good network of road and rail services in the region. Road access to most of the property is possible via numerous gravel roads from both Highways 54 and 62. In addition, there is a railway approximately 40 km east of San Tiburcio that crosses both highways (Figure 5.1). There is a high voltage powerline transecting the property near San Tiburcio. A new 34.5 kV powerline that will provide electricity to the project is under construction and as of the effective

date of this Technical Report is 49% complete. The line will have capacity for 10MW and connect the project to the national electric grid at Concepción del Oro.

The Project site is generally flat with adequate space for development of mining and processing facilities. Surface rights over the area required for Project infrastructure development, including access from the adjoining highway, and most of the open pit are subject to a Previous to Expropriation Occupation Agreement (COPE), as described in Section 4.0. Surface rights for the part of the pit that is on the Fresnillo mineral concession are subject to the Layback Agreement.

Prior operators purchased ground water from owners of local wells and trucked the water to site for drilling needs. On 24 February 2015, Camino Rojo SA de CV acquired subsurface water rights totaling 9,695,900 m³ per annum for industrial use. These water rights were subsequently transferred to Minera Peñasquito SA de CV and then assigned to MCR. The water rights acquired by Minera Camino Rojo grant permission to construct and extract water from 26 wells in the Project area. Four water wells were constructed by prior operators of the Project. Pump test results from well CR-01 were indicative that significant water production is feasible from structural zones within the Caracol Formation, but additional test borings in 2018 and 2019 failed to encounter significant water in the Caracol Formation. In 2019, MCR constructed and tested two additional wells, one of which was highly productive, producing water from the Cuesta del Cura Formation. Orla's hydrogeologic consultants believe that the wells built in 2019 are adequate to meet projected Project water needs of 24 L/s average demand (Barranca Group, 2019).

Most exploration and operating supplies may be purchased in the nearby historic mining cities of Zacatecas, Fresnillo and Saltillo. Experienced mining personnel are available locally and from nearby mining towns of Concepción del Oro and Mazapil.

Potential waste disposal areas, heap leach pad areas, process plant sites and infrastructure facilities are discussed in Sections 16.0, 17.0 and 18.0.

6.0 HISTORY

6.1 Prior Ownership

Orla's mining concessions comprising the Camino Rojo property were originally staked to the benefit of Canplats de Mexico, S.A. de C.V., a subsidiary of Canplats Resources Corporation (Canplats), in 2007. In 2010, Goldcorp acquired 100% of the concession rights held by Canplats. Orla acquired the Project from Goldcorp in 2017.

6.2 Prior Exploration

The Camino Rojo gold-silver-lead-zinc deposit was discovered in mid-2007, approximately 45 km southwest of Concepción del Oro, and was originally entirely concealed beneath post-mineral cover in a broad, low relief alluvial valley adjacent to the western flank of the Sierra Madre Oriental. Mineralized road ballast, placed on a dirt road near San Tiburcio, Zacatecas, was traced to its source by geologists Perry Durning and Bud Hillemeier from La Cuesta International, working under contract to Canplats. A shallow pit excavated through a thin veneer of alluvium, located adjacent to a stock pond (Represa), was the discovery exposure of the deposit. Following a rapid program of surface pitting and trenching for geochemical samples, Canplats Resources began concurrent programs of surface geophysics (resistivity and induced polarization) and RC drilling in late 2007, which continued into 2008.

The initial drilling was focused on a 450m x 600m gold in rock geochemical anomaly named the Represa zone. Core drilling began in 2008. The geophysical survey defined two principal areas of high chargeability: one centred on the Represa zone and another 1km to the west named the Don Julio zone. Drilling demonstrated that the Represa and Don Julio zones are part of the same mineralized zone which crops out at Represa and plunges to the west. The elevated chargeability zones were interpreted as large volumes of sulphide mineralized rocks. Drilling by Canplats, and later drilling by Goldcorp, confirmed the presence of extensive sulphide mineralization at depth in the Represa zone, and much lower quantities of sulphide minerals at Don Julio.

By August of 2008, Canplats drilled a total of 92 RC, and 30 diamond-core holes, for a total of 23,988 and 16,044 metres respectively, mainly focused in the Represa zone. The surface access and permission to continue drilling were cancelled in early August 2008, by the ejido of San Tiburcio, Zacatecas. Nevertheless, in November 2008, Canplats published an independent Mineral Resource estimate for the Represa zone, as discussed in Section 6.4 of this Technical Report.

In October 2009 Canplats publicly released a Preliminary Economic Assessment of the Project (Blanchflower K. K., 2009) which has been superseded by later work and technical studies, and is no longer current and accordingly should not be relied upon.

Canplats was acquired by Goldcorp in early 2010. Validation, infill, condemnation, and expansion drilling began in January 2011. By the end of 2015, a total of 279,788 metres of new core drilling in 415 drillholes and 20,569 metres of new RC drilling in 96 drillholes was completed in the Represa and Don Julio zones and their immediate surroundings. An additional 31,286 metres of shallow RAB-style, RC drilling in 306 drillholes was completed, with most of the RAB drilling testing other exploration targets within the concession. Airborne gravity, magnetic and TEM surveys were also carried out, the results of which are in the archives of Minera Camino Rojo.

As of the end of 2015 a total of 295,832 metres in 445 diamond core holes, 44,557 metres in 188 RC drillholes, and 31,286 metres of RAB drilling had been completed.

Locations of historical drillholes and the Project claim boundaries are summarized in Figure 6.1.

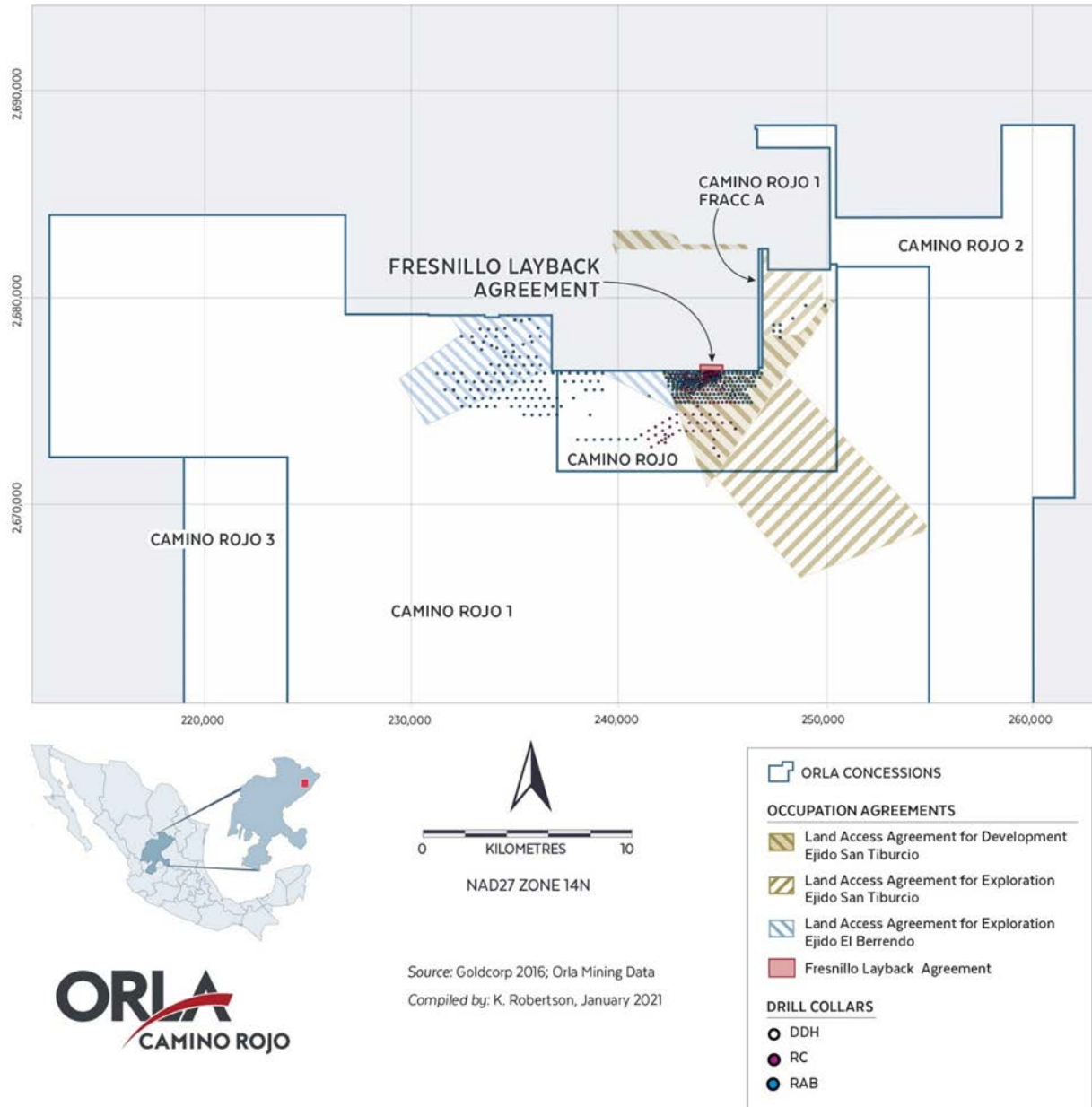

Figure 6.1 Historical Drillhole Locations and Project Claim Boundaries

Mineral Reserve and Mineral Resource tabulations for Camino Rojo were publicly disclosed by Goldcorp as recently as 30 June 2016, as discussed in Section 6.4 of this Technical Report. The methodology of Goldcorp’s Mineral Resource estimations has not been disclosed and Dr. Gray has not confirmed the validity of the estimate, thus the Goldcorp estimates are regarded as historical estimates only, as discussed in Section 6.4 of this Technical Report and have since been replaced by current Mineral Resource estimates.

6.3 Historical Metallurgical Studies

Canplats, Goldcorp and Orla conducted metallurgical tests which are discussed in Section 13.0 of this Technical Report.

6.4 Historical Resource Estimates

6.4.1 Canplats

Minorex Consulting Ltd. prepared a Mineral Resource estimate for Canplats in 2009 (Blanchflower J., 2009) that was publicly disclosed in a Technical Report prepared in accordance with the disclosure standards of NI 43-101. However, since the effective date of the Mineral Resource estimate, significant additional drillhole data has become available, rendering the 2009 estimate obsolete. **The 2009 resource estimate is historical in nature, has not been verified by the authors and should not be relied upon. Orla is not treating the historical estimate as a current estimate.**

6.4.2 Goldcorp

Goldcorp publicly disclosed Mineral Reserve and Mineral Resources on Camino Rojo with an effective date of 30 June 2016 (Goldcorp, 2017) which is no longer current. **The key assumptions, parameters, and methods used by Goldcorp to prepare the historical estimate are unknown. The 2016 reserve and resource estimates are historical in nature, have not been verified by the author, and should not be relied upon. Orla is not treating these historical estimates as current estimates.**

Current Mineral Resource and Mineral Reserve estimates are reported in Sections 14 and 15, respectively, in this Technical Report.

6.5 Prior Production

There has been no recorded mineral production from the property. Surface gravels have been used for road material and a shallow excavation made for gravel extraction created the discovery exposure of the Camino Rojo deposit.

7.0 GEOLOGICAL SETTING AND MINERALIZATION

7.1 Sources of Information

The following geological discussion is derived from a variety of peer-reviewed professional papers focused on the regional geology (Mitre-Salazar, 1989) (Centeno-Gracia, 2005) (Aranda-Gomez, 2006) (Nieto-Samaniego, 2007) (Loza-Aguirre I. N., 2008) (Tristán-González, 2009) (Barboza-Gudiño, 2010) (Weiss, 2010) (Ortega-Flores, 2015) (Cruz-Gámez, 2017), a Master's of Science thesis from the University of Nevada-Reno that details the deposit geology (Sanchez, 2017), geologic maps published by the Servicio Geologico Mexicano, field and diamond drill core observations by Dr. Matthew Gray (Gray M. D., 2016) (Gray M. D., 2018) and Dr. Anthony Longo (Longo, 2017) (Longo, A.A., Edwards, J., 2017), and regional stratigraphy from previously published Technical Reports (Blanchflower K. K., 2009).

7.2 Regional Geology

The Camino Rojo deposit is located beneath a broad pediment of Tertiary and Quaternary alluvium (Figure 7.1) along the boundary between the Mesa Central physiographic province and the Sierra Madre Oriental fold and thrust belt near the pre-Laramide continental-margin. Oldest rocks are Triassic metamorphic continental rocks overlain by Early to Middle Jurassic red beds. Upper Jurassic to Upper Cretaceous marine facies rocks overlie the red beds at a disconformity and comprise a package of shelf carbonate rocks comprising the Zuloaga to Cuesta del Cura Formations and the basin-filling flysch sediments of the Indidura and Caracol Formations (Nieto-Samaniego, 2007), (Ortega-Flores, 2015). The deposit lies within the southern extent of the northwest striking San Tiburcio fault zone (Weiss, 2010).

A Permo-Triassic tectono-volcanic arc in the eastern Sierra Madre Oriental represents the first Pacific-directed subduction and tectonism in Central Mexico (Centeno-Gracia, 2005). Erosion of the eastern Triassic highlands shed siliciclastic material westward and turbidites off the continental shelf into the Triassic basin plains. These marine clastic rocks, the Triassic Zacatecas and El Alamar Formations (Cruz-Gámez, 2017) were subsequently metamorphosed to phyllites and schists (Nieto-Samaniego, 2007) then eroded before continental siliciclastic rocks or red beds were deposited atop an angular unconformity in Early Jurassic (Nazas Formation and later La Joya Formation) (Barboza-Gudiño, 2010). A disconformity atop Lower Jurassic continental rocks preceded deposition of marine carbonate rocks belonging to the Zuloaga and La Caja Formations in Late Jurassic. Following a cessation of volcanism, arc magmatism flared up in the west along the Guerrero arc and continued through Late Cretaceous. Deposition of the shelf carbonate rocks progressed into Early Cretaceous with Taraises, Cupido, La Peña and Cuesta del Cura Formations. Upper Cretaceous flysch sediments derived from the erosion of the western Guerrero arc were deposited in the back-arc basin atop the carbonate rocks. The Mesozoic

marine sediments were deformed during the Laramide orogeny from Late Cretaceous to Paleocene forming the Sierra Madre Oriental fold and thrust belt (Nieto-Samaniego, 2007).

By late Paleocene, northeast of Mesa Central, a flexural bend in the fold and thrust belt deflected the Mesozoic strata into a series of west- and northwest-trending fold axes and faults (Tristán-González, 2009). South of the westward deflection, the fold belt strikes south to southeast. By early Eocene, the initial pulse of extensional tectonics produced north-northeast to north-northwest normal and strike-slip faults that bound mountain ranges (Matehuala fault zone) and deformed the southeast-trending fold belt along the eastern boundary of Mesa Central (Loza-Aguirre I. N., 2008). By middle Eocene, ranges in the fold and thrust belt were displaced and truncated by northwest-striking high angle faults that translated through the Mesa Central and feature both normal and strike-slip displacement (Nieto-Samaniego, 2007) (Tristán-González, 2009). Subsequent pulses of extension occurred from early Oligocene to Miocene and Pliocene to Quaternary that reactivated existing faults in conjunction with basaltic fissure volcanism and isolated monogenetic basaltic cinder cones (Aranda-Gomez, 2006).

The northwest faults include two major fault systems that localized middle Eocene to Oligocene magmatic activity and define the southern and northern boundaries of Mesa Central. The southern fault zone known as the San Luis-Tepehuanes fault system separates the Sierra Madre Occidental from Mesa Central and localizes numerous mineral deposits (Nieto-Samaniego, 2007) (Loza-Aguirre I. N., 2008). The northern fault zone known as the San Tiburcio lineament and fault zone extends for more than 185km and features both left-lateral strike-slip and normal displacement (Mitre-Salazar, 1989). The fault truncates west-trending anticlinal axes in the flexural bend of the Sierra Madre Oriental and may crosscut the NNE-trending Matehuala fault zone that bounds the eastern Mesa Central. Anticlinal fold axes and faults parallel the San Tiburcio fault zone, and granitic intrusive rocks and dacitic to andesitic dikes are localized along portions of its extensive strike length.

Mineralization styles in the region include polymetallic and copper-gold skarn and limestone manto (replacement) silver-lead-zinc sulphide ores. The nearest significant producing mines or past producers are Newmont's Peñasquito mine, located 53km N-NW of Camino Rojo, and various mines of the Concepción del Oro district, 47km N-NE of Camino Rojo. The Peñasquito mine exploits gold-silver-lead-zinc mineralization hosted in igneous diatreme-breccia and the surrounding Caracol Formation. Peñasquito mineralization gives way at depth to copper-gold sulphide breccias in garnet skarn, within limestone beneath the Caracol Formation (Rocha-Rocha, 2016). Concepción del Oro mines produced from polymetallic and copper-gold skarn deposits and limestone-hosted manto (replacement) silver-lead-zinc sulphide deposits adjacent to Late Eocene igneous intrusions (Buseck, 1966). **Dr. Gray has not verified this information and the mineralization described for the mines and mineral deposits in this section is not necessarily indicative of the mineralization at the Camino Rojo, Zacatecas property.**

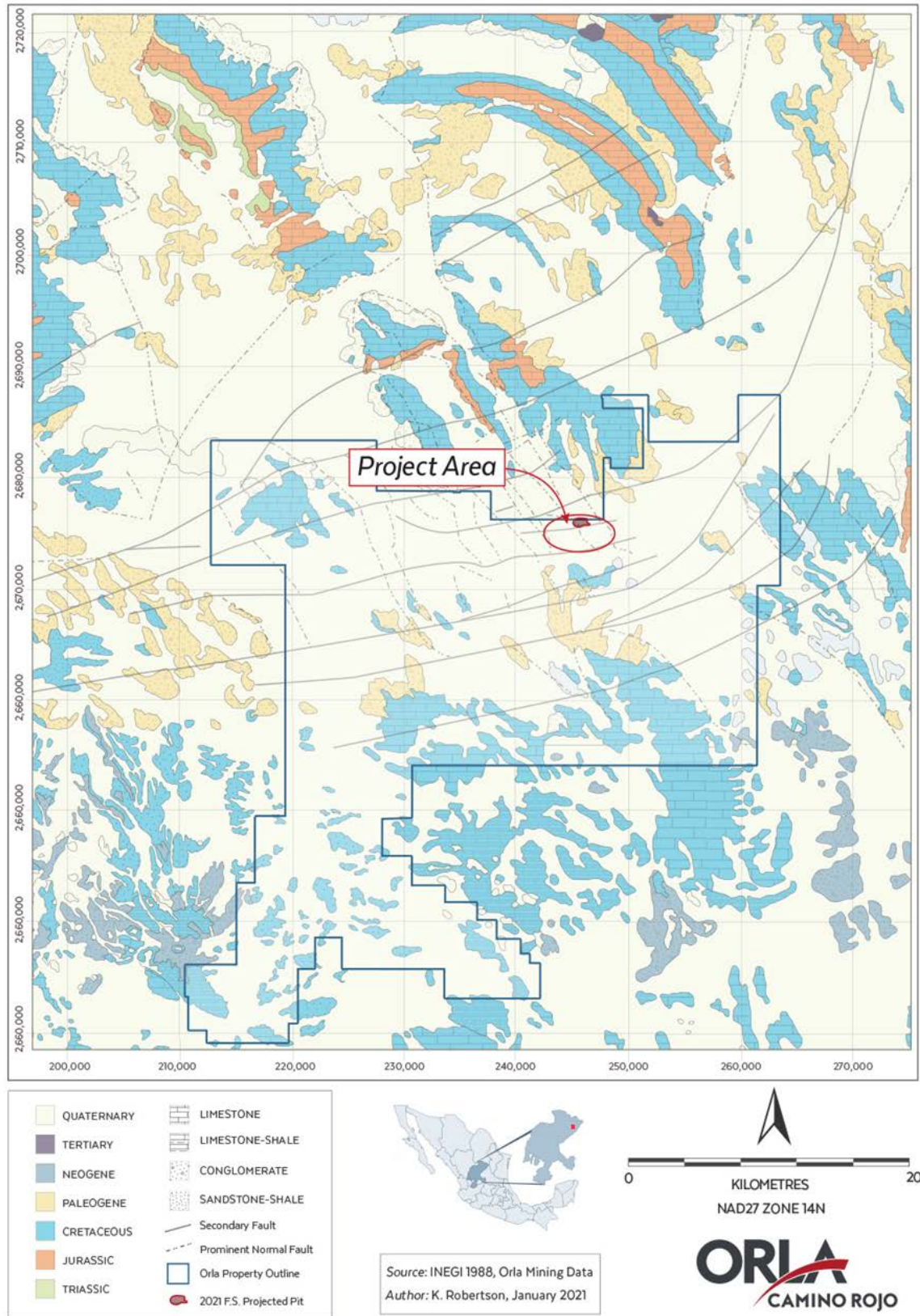

Figure 7.1 Regional Geologic Map (Servicio Geológico Mexicano, 2000)

7.3 Local Geology

7.3.1 General Deposit Geology

Camino Rojo is a gold-silver-zinc-lead deposit concealed below shallow (<1 to 3 m) alluvial cover in a large pediment along the southwest border of the Sierra Madre Oriental (Weiss, 2010). Small water storage pits and trenches expose a portion of the oxide deposit in the discovery area known as the Represa zone (i.e., water reservoir). The Late Cretaceous Caracol Formation is the primary host to mineralization, and at depth, the upper Indidura Formation is a minor host near the Caracol contact. The local geology is summarized in Figure 7.2. The deposit stratigraphy, known from current diamond drilling, is discussed below from oldest to youngest.

Early Cretaceous Cuesta del Cura Formation features thin- to medium-bedded grey limestone with wavy laminations and locally discontinuous layers of black shale and chert. Polymetallic replacement manto-type occurrences are typically found in Cuesta del Cura elsewhere in the region. No significant mineralization has been found in these limestones at Camino Rojo. Late Cretaceous Indidura Formation features thin-bedded calcareous shale, grey shaley limestone and siltstone with estimated thicknesses that range from 100 to 220 metres (Figure 7.3). Atop the Indidura, the Caracol Formation consists of thinly interlayered carbonaceous and calcareous siltstones, silty mudstones, and fine-grained calcareous sandstone, and thicknesses range from 600 to 800 metres (Figure 7.4). Sandstone layers typically display cross-laminations, and the lowest occurrence of sandstone is considered the Indidura contact (Sanchez, 2017). Camino Rojo vein-style mineralization has not been found to extend below the Indidura into the Cuesta del Cura Formation, although drilling is sparse. The few drill holes that have penetrated below Indidura discovered marbleized limestone and slight calc-silicate hornfels alteration in the Cuesta del Cura Formation (Figure 7.5).

Three genetically different types of igneous dikes intruded the Cretaceous marine sediments at Camino Rojo. Type 1 dikes are medium- to coarse-grained porphyritic hornblende-biotite-feldspar porphyry. Type 2 dikes are fine-grained with rare quartz phenocrysts (1-2mm diameter). Type 3 dikes have coarse-grained hornblende with plagioclase (Sanchez, 2017). The dikes consistently display hydrothermal alteration so the actual petrologic and chemical compositions are unknown. They are assumed as intermediate composition igneous dikes (Sanchez, 2017). Drill-supported models created by Orla show dikes are oriented in two parallel subvertical northeast-trending planes spatially associated with the deposit shape. Ore stage IS veins crosscut the dikes and feature bleached halos of sericite alteration.

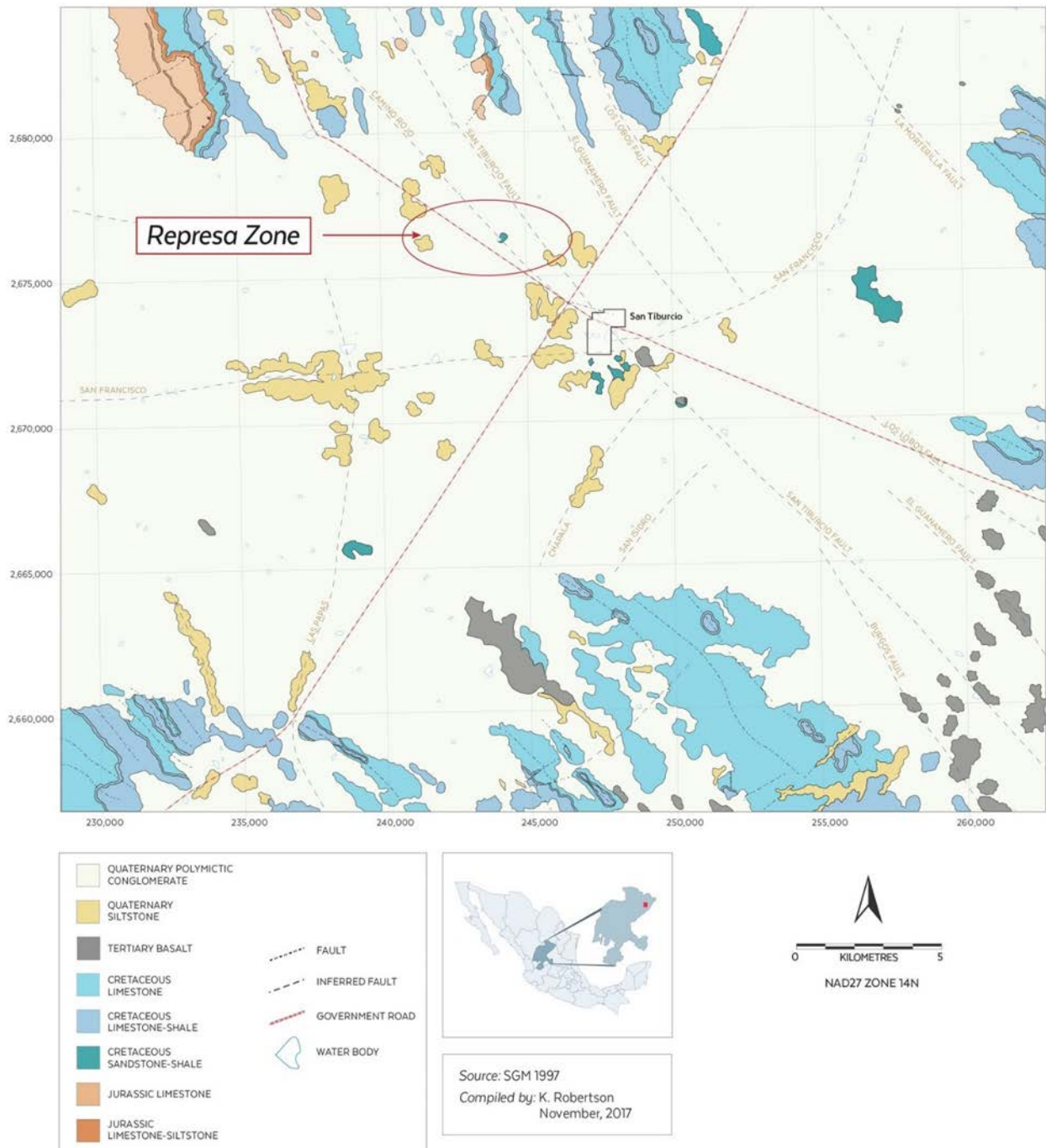

Figure 7.2 Local Geology, Camino Rojo Deposit (Servicio Geológico Mexicano, 2014)

Figure 7.3 shows relatively uniform nature of siltstone and shale beds in Indidura Formation, stratigraphically below Caracol Formation. Indidura is distinguished from Caracol by the absence of rhythmic sandstone-shale beds. Interval from 817.5 to 819.0m assayed 18 ppb Au.

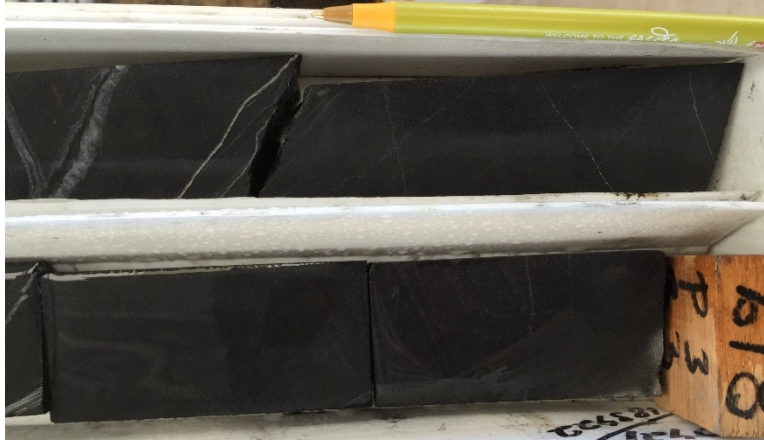

Figure 7.3 Drillcore from CR12-345D, 818m

Figure 7.4 shows typical and diagnostic interbedded centimetre scale sandstone, siltstone, and shale beds, fining upward turbiditic sequence, in unoxidized Caracol Formation. Sample assayed less than 5 ppb Au. Stratigraphic top is to right.



Figure 7.4 Drillcore from CR12-345D, 254m

Figure 7.5 shows marbleized Cuesta del Cura limestone, stratigraphically below the Indidura Formation. Interval from 991.5 to 993.0m assayed 44 ppb Au.



Figure 7.5 Drillcore from CR12-345D, 993m

7.3.2 Structural Setting

The Camino Rojo deposit is situated within the northwest-striking San Tiburcio fault zone that features both left-lateral strike-slip and normal displacement (Mitre-Salazar, 1989) (Weiss, 2010). Anticlinal fold axes and faults parallel the San Tiburcio fault zone lending credence to a possible 15 km wide zone, encompassing Camino Rojo, which experienced extensional deformation. The deposit has a northeast trend that plunges southwest. Intermediate composition dikes localized within the deposit also strike northeast.

7.3.3 Mineralized Zones

Three stages of mineralization have been observed in the Camino Rojo deposit, and two types of high-grade mineralization (Longo, 2017) (Longo, A.A., Edwards, J., 2017).

Stage 1 K-metasomatism (adularia?)-pyrite - K-metasomatism with disseminated pyrite replaced the mudstone, siltstone and fine-grained sandstones in the Caracol. Mineralization is typically low-grade gold with 0.1-0.4 g/t (Figure 7.6, Figure 7.7).

Stage 2 Intermediate Sulphidation (IS) veins – IS veins with pyrite-arsenopyrite-sphalerite±galena, calcite and minor quartz. Moderate to high grade gold (0.4 to +4.0 g/t), high zinc grades (0.5 to >2.0% Zn) and high values of As, Pb and Ba, with variable Ag. Sanchez (2017) reports electrum and acanthite in Stage 2.

IS Type 1 are pyrite-sphalerite-calcite veins with high values of Au-Zn-Ba, and low to moderate values of As, low Sb, and moderate to high Pb (Figure 7.8).

IS Type 2 – IS veins with pyrite-arsenopyrite-quartz ±calcite and sphalerite-sulphosalts, high gold (up to 60 g/t), Ag, As, Sb.

Stage 3 LS veins – colloform banded quartz veins, drusy-coxcomb quartz veins, and quartz-cemented, polymictic hydrothermal breccia with pyrite-galena-sulphosalts, adularia and electrum. Moderate to high gold grades (2.0 to 15.0 g/t) with high silver (100 to 500 g/t), and high As and Sb values, but variable to low Zn, Pb, and Ba values.

At hand specimen scale, mineralization is controlled by bedding and fractures. The sandy and silty beds of the turbidite sequences of the Caracol Formation are preferentially mineralized, with pyrite disseminations and semi-massive stringers hosted within them, presumably due to higher porosity and permeability relative to the enclosing shale beds. Basal layers of the turbiditic sandstone beds are often preferentially mineralized (Figure 7.6, Figure 7.7). Bedding discordant open space filling fractures and structurally controlled breccia zones host banded sulphide veins and sulphide matrix breccias (Figure 7.8, Figure 7.9). Some higher-grade vein and breccia zones are localized along the margins of dikes of intermediate composition.

Dr. Gray observed mineralization in drill core over vertical intervals greater than 400 metres, with mineralization occurring in a broad NE-SW trending elongate zone as much as 300m wide and 700m long.

Figure 7.6 displays pyrite concentrations developed in basal sandy layer of fining upward sandstone-siltstone-shale/mudstone turbiditic sequence of Caracol Formation. Note textbook turbiditic sequence comprised of cross bedded sandstone above laminar basal sand, and scour marks of basal sand into black pelagic sediments that mark top of lower and base of upper turbidite sequence. Stratigraphic up is to right of photo. Interval from 394.5 to 396.0m assayed 0.211 g/t Au, 8 g/t Ag, 101 ppm Pb, 128 ppm Zn, and 245 ppm As.

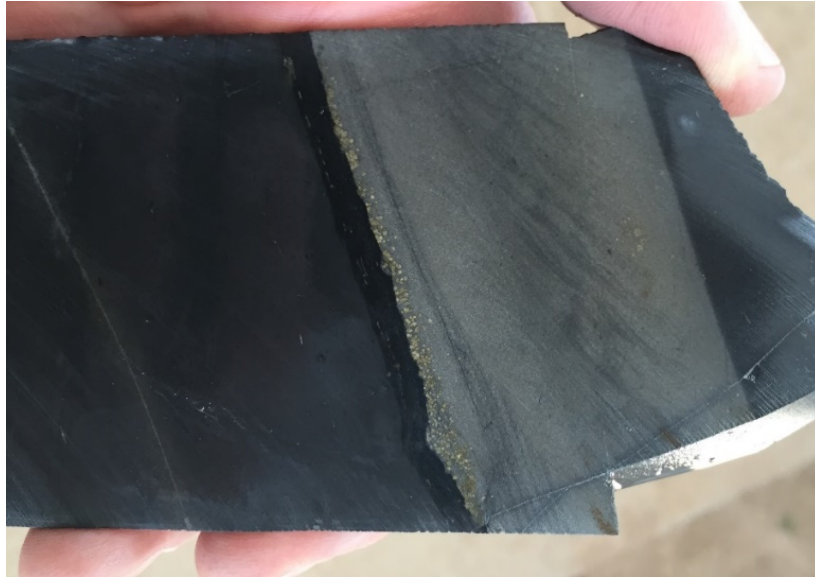

Figure 7.6 Drillcore from CR12 345D, 395m

Figure 7.7 shows pyrite concentrations developed in silty and sandy beds of turbiditic sequence of Caracol Formation. Stratigraphic up is to right of photo. Interval from 726.0 to 727.5m assayed 0.109 g/t Au, 1 g/t Ag, 19 ppm Pb, 56 ppm Zn, and 114 ppm As.

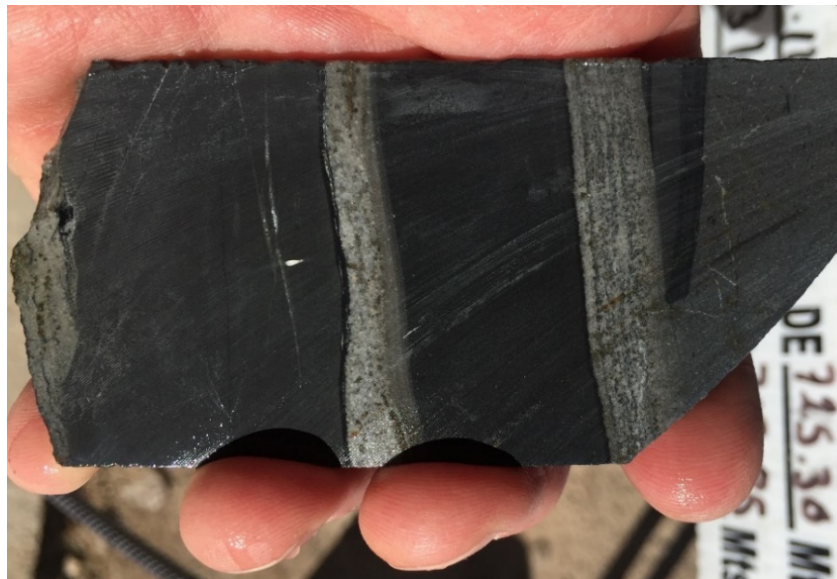

Figure 7.7 Drillcore from CR12 345D, 727m

Figure 7.8 displays banded pyrite-marmatite (Fe rich sphalerite) carbonate veinlet. Interval from 489.5 to 491m assayed 4.76 g/t Au, 22 g/t Ag, 572 ppm Pb, 16850 ppm Zn, and 7240 ppm As. Surrounding sample intervals without discordant sulphide veinlets assayed only 0.79 and 0.28 g/t Au. Note that sulphide veinlet is nearly parallel to core axis.



Figure 7.8 Drillcore from CR11 267D, 490m

Figure 7.9 illustrates pyrite-marmatite (Fe rich sphalerite) matrix bedding discordant breccia. Interval from 471.5 to 473.0m assayed 1.71 g/t Au, 14 g/t Ag, 411 ppm Pb, 3050 ppm Zn, and 4290 ppm As. Surrounding sample intervals without discordant sulphide veinlets assayed only 0.19 and 0.31 g/t Au.



Figure 7.9 Drillcore from CR11 267D, 473m

7.3.4 Alteration

Distinct alteration styles accompanied each stage of mineralization (Longo, 2017) (Longo, A.A., Edwards, J., 2017):

Stage 1 K-metasomatism (adularia? flooding), decarbonization and sulphidation (forming fine-grained pyrite). This alteration assemblage is typically associated with low metal concentrations, except where cut by IS veins, then grades increase. Temperature of this event is unknown and likely not a high temperature (>400 to 700°C) event characteristic of K-silicate alteration in porphyry Cu deposits.

Stage 2 sericite-calcite ±pyrite-quartz overprints Stage 1 and is associated with pyrite-arsenopyrite and pyrite-sphalerite-galena ore stage veins (Sanchez, 2017). Veins that crosscut the igneous dikes display prominent alteration halos. Sericitic halos to ore stage veins are not visually obvious in the sedimentary rocks with intense K-metasomatism.

7.4 Oxidation

Oxidation was observed to range from complete oxidation in the uppermost portions of the deposit, generally underlain or surrounded by a zone of mixed oxide and sulphide mineralization where oxidation is complete along fracture zones and within permeable strata, but lacking in the remainder of the rock, which then is generally underlain by a sulphide zone in which no oxidation is observed.

Oxidation is ~100%, generally extending from surface to depths of 100m to 150m, and to depths of as much as 400m along fracture zones. The underlying transitional zone of mixed oxide/sulphide extends over a vertical interval in excess of 100m and is characterized by partial oxidation controlled by bedding and structures.

The sandy layers of the turbiditic sequence are preferentially oxidized, creating a stratigraphically interlayered sequence of oxide and sulphide material at the centimetre scale (Figure 7.10), with oxidation along structures affecting all strata (Figure 7.11). The partial oxidation of the Caracol Formation preferentially oxidizes the mineralized strata thus incomplete oxidation in the transition zone may result in nearly complete oxidation of the gold bearing portion of the rock, thus the metallurgical characteristics of mixed oxide/sulphide may vary greatly, with some material exhibiting characteristics similar to oxide material.

Figure 7.10 displays partially oxidized mineralized Caracol Formation. Note that oxidation is controlled by both bedding and structures. Sandy turbiditic beds are preferentially oxidized in the oxide/sulphide transition zone, whereas interlayered mudstone and shale beds are unoxidized. Oxidation affects all beds adjacent to structures.



Figure 7.10 Drillcore from CR11 258D, 256m

Figure 7.11 shows oxidized Caracol Formation. Interval from 256.5 to 258.0m assayed 3.52 g/t Au, 33 g/t Ag, 6070 ppm Pb, 6060 ppm Zn, and 2590 ppm As. Note the oxidized sulphide veinlet crosscutting bedding, seen below the knife.



Figure 7.11 Drillcore from CR11 258D, 257m

7.5 Conclusions

The distribution of mineralization at Camino Rojo is controlled by both primary bedding and discordant structures. Pervasive, near surface oxidation extends to depths in excess of 100m, and extends to greater depths along structurally controlled zones of fracturing and permeability.

8.0 DEPOSIT TYPES

The observed geological and geochemical characteristics of the gold-silver-lead-zinc deposit at Camino Rojo are consistent with those of a distal oxidized gold skarn deposit. Characteristics of these deposits (Meinert, L.D., Dipple, G.M., and Nicolescu, S., 2005) are summarized as:

- Typically found in lithologies containing some limestone, but deposits not restricted to limestones.
- Formed by regional or contact metamorphic processes by metasomatic fluids, often of magmatic origin.
- Typically zoned deposits with a general pattern of garnet and pyroxene minerals proximal to the mineralizing heat and fluid source, and distal zones of bleaching.
- Low total sulphide content.
- Sulphide mineralogy comprised of pyrite, pyrrhotite, chalcopyrite, sphalerite, and galena.
- Highest gold grades are associated with late, relatively lower temperature mineralizing events, often with potassium feldspar and quartz gangue.
- May be transitional to epithermal deposits.

The near surface portion of the Camino Rojo deposit has characteristics consistent with those of the distal skarn zone, transitional to epithermal mineralization, and overlies garnet bearing skarn mineralization encountered in the deeper portions of the system.

Skarn deposits often exhibit predictable patterns of mineral zoning and metal zoning. Application of skarn zoning models to exploration allows for inferences about the possible lateral and depth extents of the mineralized system at the Camino Rojo deposit and can be used to guide further exploration drill programs.

9.0 EXPLORATION

Orla has conducted reconnaissance geological evaluations of portions of its mining concessions. Exploration activities completed include: geologic mapping; rock chip and soil geochemical sampling; and induced polarization geophysical surveys. As of the effective date of this Technical Report, 695.2 line-km of induced polarization geophysical surveys have been completed in 4 separate grids over the known area of mineralization, over the proposed area of infrastructure development, and to the west and south of the resource area, and over 5 separate grids in the Camino Rojo 5 concession. All grids were designed with 400m line separation and stations every 100m. Dipole spacing was selected to search for features at depths greater than 100 to 200m. Chargeability anomalies with some similarities to the Camino Rojo deposit were identified (Figure 9-1). Three anomalies in the vicinity of the Represa Zone were drill tested by nineteen reverse circulation holes totalling 5,662.5 meters. No significant mineralization was encountered

Five separate IP grids in the Camino Rojo 5 claim defined several chargeability anomalies with some similarities to the Camino Rojo (Figure 9.1). As of the date of this Technical Report, one of the chargeability anomalies at the Las Miserias target had been drill tested by seven reverse circulation drillholes totaling 2,096.5m. No significant mineralization was encountered.

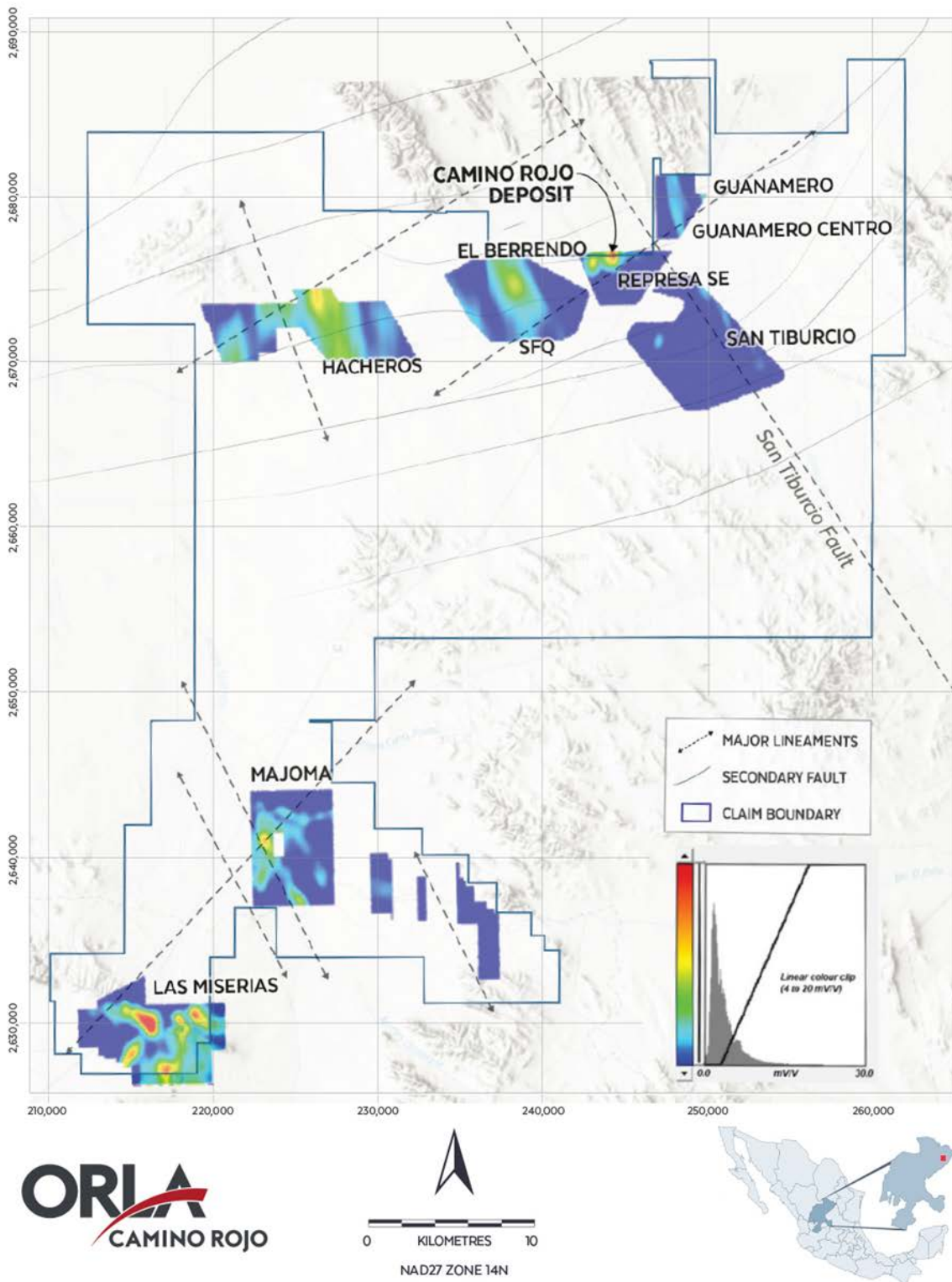

Figure 9.1 Exploration Targets and Chargeability Features from Orla’s 2018, 2019, and 2020 IP Surveys

A small orientation soil survey has been conducted over the resource area and 66 soil samples were collected. Results from the orientation soil survey over the known deposit area to test for any characteristic signature indicates the geochemical “halo” over the deposit is tightly restricted to sub/outcrop. Anomalous gold (>0.2 g/t) is most closely associated with elevated arsenic (>100 ppm) and zinc (>300ppm). More than 1,500 rock chip samples have been collected from throughout the mining concessions comprising the Project. Thus far no significant rock chip gold anomalies have been identified but low-level anomalies were detected in the Las Miserias area, associated with a silicified breccia and a chargeability anomaly.

Rock samples collected during the regional exploration are sent to the ALS Minerals (ALS) sample preparation facility in Zacatecas, Mexico. Sample analysis is performed in the ALS laboratory in Vancouver, British Columbia. All gold results are obtained by ALS using fire assay fusion and an atomic absorption spectroscopy finish (Au-AA23). All samples are also analysed for multi-elements, including silver, copper, lead, and zinc, using an Aqua Regia (ME-ICP41) digestion.

Regional exploration continues to field check interpreted targets, consisting of coincident historical geochemical, airborne geophysical and satellite imagery anomalies. Ten areas of alteration of sedimentary strata have been identified, and although no significant geochemical results have been returned from them to date, they are considered of interest as possible distal alteration zones to mineralized areas.

The ten target areas defined by geophysical and geochemical surveys are shown on Figure 9.1 and are:

- 1) Guanamero, which lies northeast of the Represa Zone, along the trend of mineralization, and hosts recrystallized limestones of the Cuesta del Cura Formation.
- 2) Guanamero Centro, located along the NE trace of dikes and faults that of the Represa deposit, where outcropping sills and dikes were intercepted in two drillholes, hosted in Indidura-Caracol strata.
- 3) Las Miserias, a zone of structural intersections with jasperoid and breccias developed in Cretaceous limestones.
- 4) Represa SE, immediately SE of the Represa deposit, where geochemical Au-Zn anomalies were identified in historic RAB drillholes.
- 5) San Tiburcio, where geochemical anomalies coincide with a chargeability anomaly along a fault NW of the San Tiburcio fault system.
- 6) SFQ San Francisco de los Quijanom, an area of scarce outcrops of Caracol strata, with several magnetic anomalies which could be the SW extensions of structures of the Represa deposit.
- 7) Hacheros, where Indidura Formation limestones and siltstones are bleached and highly fractured with Fe-oxides and carbonate veinlets along fractures.

- 8) Pozo de San Juan- Las Catas, which hosts old mining prospects that expose Ag-Pb-Zn mineralization in recrystallized limestones of the Cupido Formation.
- 9) El Berrendo area, a colluvium covered area where geochemical anomalies and alteration were identified in historic RAB drillholes.
- 10) Majoma, where a polymictic breccia, possibly hydrothermal, and hematized Caracol Formation are observed.

As of the effective date of this Technical Report, Orla has a planned exploration program including:

- 2,500 metres of core drilling to confirm mineralization on the Fresnillo property that is subject to the Layback Agreement.
- A directional diamond drilling program to test the sulfide zone, over the down plunge extension of the Camino Rojo deposit.
- Continuation of the regional exploration program to discover satellite deposits near the Camino Rojo deposit including 7,500-metres of rotary air blast (“RAB”) reconnaissance drilling to test areas where bedrock is covered by soil and colluvium. The results from the RAB drilling, in combination with 200 line km of planned IP surveys, will define property exploration targets.

10.0 DRILLING

10.1 General

The drillhole database used for the Feasibility Study contains 911 drillholes and 370,566m of drilling. Table 10-1 summarizes the drilling by company, date, and type of drilling. During 2007 and 2008 Canplats drilled 121 holes for 39,831m of drilling, about 11% of the drilling by metres. This was 92 RC holes and 29 core holes. Between 2011 and 2015 Goldcorp drilled 779 holes for 328,587m of drilling. These were 95 RC holes, 306 RAB holes, and 378 core holes. The 2015 holes and some of the late 2014 holes were drilled for geotechnical investigations. Orla drilling included in the Mineral Resource estimate was conducted during 2018 and consisted of 6 RC holes for 803m of drilling and 5 core holes for 1,345m of drilling, totalling 11 holes and 2,148m of drilling.

There has been no new drilling for the Mineral Resource since the 2019 Technical Report and this section is the same as presented in the 2019 Technical Report. There was limited non-resource drilling completed by Orla in 2018, 2019 and 2020 as discussed in this section.

Compared with the drilling reported in Section 6.2 of this Technical Report, Table 10-1 reports one less Canplats core hole, one less Goldcorp RC hole, and 37 less Goldcorp core holes. It is known that some of the historical drilling in Section 6.2 is well outside the current Project area. The remainder of the historical drilling is included in the current database for the purposes of the Feasibility Study.

Table 10-1
Summary of Camino Rojo Drilling, 2007-2018

Year	Company	RC Holes		RAB Holes		Core Holes		Total Holes	
		Holes	Metres	Holes	Metres	Holes	Metres	Holes	Metres
2007	Canplats	12	2,367					12	2,367
2008	Canplats	80	21,621			29	15,843	109	37,464
2007-08	Canplats	92	23,988			29	15,843	121	39,831
2011	Goldcorp	91	18,447	138	10,008	124	54,249	353	82,704
2012	Goldcorp	4	1,116	160	18,514	38	35,606	202	55,236
2013	Goldcorp					134	110,305	134	110,305
2014	Goldcorp			8	2,764	79	75,478	87	78,242
2015	Goldcorp					3	2,100	3	2,100
2011-15	Goldcorp	95	19,563	306	31,286	378	277,738	779	328,587
2018	Orla	6	803			5	1,345	11	2,148
ALL		193	44,354	306	31,286	412	294,926	911	370,566

Note: Quantity of drillholes is less than the historical record in Section 6.2. It is known that some of the historical drilling in Section 6.2 is well outside the current Project area. The remainder of the historic drilling is included in the current database.

Figure 10.1 shows the drillhole locations by drilling type and Figure 10.2 shows the drilling by company. Note that the RAB holes are mostly peripheral to the main mineral deposit area. The denser drilling in the northeast portion of the deposit is the area of interest for the Feasibility Study. This material is relatively close to the surface and oxidized. To the southwest the mineralization is deeper with higher amounts of sulphide.

10.2 Canplats Drilling

The Canplats drilling was conducted during 2007 and 2008. It is reported the RC holes were drilled by Tiger Drilling de Mexico, S.A. de C.V. and Layne de Mexico, S.A. de C.V. (Layne). The rigs used drilled holes of either 4.75in or 5.5in (12cm or 14cm) diameter. Most of the core holes are HQ (63.5mm) and drilled by Major Drilling International Inc. Four PQ (85.0mm) holes were drilled to collect metallurgical samples, but only three of them are in the IMC database. Metallurgical holes CRM-006, CRM-014 and CRM-020 included assays for individual sample intervals in the database. CRM-038 was not in the assay database provided to IMC and it is not certain individual assays were available for this hole. Often metallurgical holes are consumed in their entirety for testing purposes.

It was reported that Canplats did not do downhole surveys for the RC holes. However, Goldcorp was able to re-enter most of the holes and do the surveys. Most of the Canplats RC holes currently have detailed downhole survey information.

Core and RC logging procedures for Canplats drilling were described by Blanchflower (2009). For RC drilling, Canplats sampling personnel extracted spoon size splits from each drill interval at the rig's cyclone splitter, washed away the fine fraction with a strainer, and placed the washed splits into divided plastic chip trays. Canplats geologists subsequently logged the RC cuttings in the office and storage building, describing each interval on paper log forms with codes for lithology, alteration, mineralization and fracturing. The logged information was later captured into electronic spreadsheet files.

Core was logged prior to hydraulic splitting and sampling. Canplats geologists used paper logging forms to record descriptions of colour, lithology, alteration, mineralization, bedding, and fracture and fault angles to the core axis. Descriptions used a combination of alpha-numeric codes and normal text, and included hand-drawn graphic sketches. The logged information was later captured into electronic spreadsheet files for importation in the database.

The Canplats drilling discovered and partially delineated the oxide mineral deposit that occurs at the northeast end of the Camino Rojo deposit, in the Represa zone. The drilling also discovered the deeper sulphide deposit to the southwest, in the Don Julio zone. This data was used to develop a Mineral Resource and PEA level study for the Represa zone by Canplats during 2009.

10.3 Goldcorp Drilling

The Goldcorp drilling was conducted from 2011 to 2015. The RC drilling was conducted by Layne and G4 Drilling. The RC holes were 4.75in to 5.125in in diameter (12cm to 13cm). The core holes were drilled by Layne, BD Drilling, and Boart-Longyear and were generally HQ core. In addition to the core and RC holes, 306 RAB holes were drilled. The average depth of these holes was only about 100m and they were mostly peripheral to the main deposit area. Downhole surveys were conducted for the core and RC drilling, but not for the RAB holes. They were assumed vertical.

Most of the holes are orientated north with an approximate 60° north plunge. This is an optimal orientation for the bedding, which dips moderately to the south/southeast. This direction is less optimal for steep north dipping structures and intercepts with narrow veins at low to very low angles to the core axis have been observed in many holes. There are two sections with holes directed to the south drilled by Goldcorp. However, it would be desirable to drill more holes directed south with a 45 to 60° south plunge to intersect structures with a similar attitude as the dike, southwest to northeast trending with a steep north dip. However, these holes require access to ground controlled by Fresnillo.

Goldcorp RC chip logging was recorded on paper log forms by Goldcorp geologists at the RC drill sites, concurrent with drilling. Washed fines and chips from each interval were examined and logged, and a spoon-sized split was placed into divided chip trays for future reference. As of the date of this Technical Report, the chip trays are available for inspection. The Goldcorp geologists described and recorded the lithology, alteration, fracture/fault zones, oxidation class, percent oxidation by volume, estimated percent and type of iron oxides, estimated percent sphalerite, galena, pyrite, and other sulphides, calcite, other veins, and colour. Descriptive text and a graphic sketch column were also recorded. These data were later captured into electronic spreadsheet files for importation into the database.

Core logging by Goldcorp was carried out on whole core, prior to any core cutting or sampling. All core was brought by Goldcorp personnel to the core logging shelter, rinsed with water, and measured from run blocks to determine core depths contained in each core box. Goldcorp geologists logged lithology, alteration, fracture/fault zones, oxidation class, and percent oxidation by volume. Graphic sketch columns for lithology, bedding, fracture and fault angles to core axes, and mineralization were also recorded. Estimated percentages of sulphide and gangue minerals, as well as their mode of occurrence were recorded as text. Logged information was later captured into electronic spreadsheet files for importation into the database. Core was also photographed prior to splitting. In 2012, the logging was modified to include fields for estimated percentages of various sulphide minerals. During 2010, Goldcorp geologists re-logged the Canplats RC drill cuttings to determine the degree of oxidation of each drill interval in terms of percent oxidation of

the rock by volume. The Goldcorp drilling further delineated both the oxide and sulphide Mineral Resources. The oxide portion of the deposit has sufficient drilling to conduct studies at the Feasibility Study level. The sulphide deposit has sufficient drilling to conduct studies at the PEA or Preliminary Feasibility level of study. More drilling would be required for a Feasibility level study.

10.4 Orla Drilling

BD Drilling of Guadalajara, Jalisco, Mexico drilled 5 HQ diameter diamond core holes totaling 1,345m in 2018. Three holes were drilled for geotechnical investigations and two were drilled to test a possible higher-grade structure proximal to the main resource area. All holes were sampled. Core logging by Orla personnel was conducted on unsplit whole core. Lithology, structure, alteration, oxidation, and mineralization data was recorded on paper drill logs, then transcribed into an electronic database. RQD and core recovery information was similarly captured. Drillcore was photographed prior to sampling.

Layne of Hermosillo, Sonora, Mexico drilled 6 RC holes totaling 803.1m in 2018. A 5 ¼” (13.34 cm) diameter face return bit with shroud was used. RC chips were logged by Orla geologists. Lithology, alteration, oxidation, and mineralization data was recorded on paper drill logs, then transcribed into an electronic database. Drill cuttings were sampled by splitting the sample at the drill rig with a cyclone, or in the case of wet samples, with a rotary splitter. Depending on recovery, a ½ or ¼ split was sent for assay and the remaining sample preserved and stored in warehouses in San Tiburcio.

Gyroscopic downhole surveys were completed for both diamond core and reverse circulation drillholes by Silver State Surveys Inc., supported by their Concepción del Oro, Zacatecas office. The Orla drilling included in the Mineral Resource model database, as of the effective date of this Technical Report, was conducted in 2018 and is summarized in Table 10-2.

Table 10-2
Drillholes by Orla Included in Mineral Resource Model Database

Drillhole	Type	Core Size	Depth (m)	Azimuth	Inclination	E UTM NAD27	N UTM NAD27	Elevation (m)	Start Date	Finish Date	Drill Contractor
CRDH18-001	DDH	HQ	250.00	160	-45	243402.68	2675882.93	1955.37	20180804	20180812	BD Drilling
CRDH18-002	DDH	HQ	369.00	155	-50	243695.74	2676093.77	1952.46	20180809	20180812	BD Drilling
CRGT18-001	DDH	HQ	250.00	135	-65	244145.55	2676170.38	1946.56	20180705	20181711	BD Drilling
CRGT18-002	DDH	HQ	240.00	205	-70	244342.02	2676141.77	1948.36	20180712	20180718	BD Drilling
CRGT18-003	DDH	HQ	236.00	50	-80	244534.84	2676143.32	1944.52	20180719	20180726	BD Drilling
CRI18-01	RC		100.58	0	-90	244142.42	2676045.35	1944.57	20180822	20180822	BD Drilling
CRI18-02	RC		100.58	180	-50	244142.24	2676043.36	1944.58	20180822	20180823	Layne
CRI18-03	RC		100.58	180	-70	244081.44	2676021.81	1945.36	20180823	20180824	Layne
CRI18-04	RC		100.58	0	-50	244046.99	2676178.62	1946.97	20180824	20180825	Layne
CRI18-05	RC		100.58	0	-90	244098.29	2676239.08	1947.77	20180825	20180825	Layne
CRI18-06	RC		300.23	180	-70	244203.57	2676197.94	1947.18	20180826	20180827	Layne

In addition to Orla drilling used in the Mineral Resource model database, through the effective date of this Technical Report, Orla has completed geotechnical, metallurgical, condemnation, regional exploration, sulphide zone exploration and water exploration and development drilling totalling 21,796.02 metres as summarized in Table 10-3.

**Table 10-3
Non-Resource Drilling Completed by Orla, 2018, 2019 and 2020**

Purpose	Drillhole Type	Total Number of Holes	Total m
Clay Exploration	DDH	5	56.00
Condemnation	RC	7	1,767.85
Geotech Infrastructure Substrate	DDH	19	323.35
Geotech/Condemnation	DDH	4	642.00
Metallurgy	DDH	14	2,288.50
Infill/Sulfide Zone	DDH	3	1,959.70
Regional Exploration	RC	26	7,759.00
Monitoring Wells	RC/rotary	11	916.51
Water Exploration	RC	16	5,340.51
Water Production	RC/rotary	2	715.60
Total		86	21,769.02

The clay exploration drilling indicated that clay required for leach pad and pond construction is present, but was not able to confirm adequate amounts. The condemnation holes verified that the proposed sites for Project infrastructure will not impede development of Mineral Resources. The geotechnical holes provided the information necessary to determine pit slope stabilities and design criteria for the process plant, leach pad, waste dumps, and ponds, and confirmed that the proposed locations for each are suitable. Metallurgical drillholes provided material for testing as described in Section 13.0 of this Technical Report. The water exploration, monitoring, and development drilling provided information needed for hydrologic modeling as described in Section 24.4 of this Technical Report and indicated that wells at the Project site can provide an adequate water supply to the Project as described in Section 18.3.1 of this Technical Report.

10.5 Sampling

10.5.1 Canplats and Goldcorp Sampling

Goldcorp sample intervals were consistently 1.5m for core, RC, and RAB drilling. For Canplats RC drilling about 20% of the sample intervals were 1.0m and 80% 2.0m intervals. Canplats core samples tended to be 2.0m intervals, but about 30% of the intervals were shorter and of random length. According to the Canplats 2009 Technical Report, the geologist could adjust the sample intervals to correspond with geologic contacts.

For the RC drilling by Canplats and Goldcorp a splitter was used at the drill rig and the sample collected in the field. For drillcore, both Canplats and Goldcorp split the samples at secure facilities and bagged them for shipment to the sample preparation laboratories.

There is no recovery information for Canplats drilling or for any of the RC or RAB drilling. The recovery for Goldcorp core was very high, generally above 90% and the overall average was about 96%.

10.5.2 Orla Sampling

Drillcore was sampled by cutting the core with a diamond disk saw and sending ½ of the core for assay and maintaining ½ of the core in the core box for archive. Sample intervals were generally 1.5m long, except where geologic contacts or lack of recovery required a different sample length. Sampling was conducted in secure facilities at the Project core logging facility in San Tiburcio.

For reverse circulation drilling, imperial unit drill rods were used, thus sample intervals were 1.524m long (5 feet). Sampling was conducted at the drill rig, and samples then transported to secure warehouse facilities in San Tiburcio.

10.6 Conclusions

10.6.1 IMC Conclusion

It is the opinion of IMC that the drilling and sampling procedures for Camino Rojo drill samples by Canplats and Goldcorp are reasonable and adequate for the purposes of this Technical Report. IMC does not know of any drilling, sampling, or recovery factors that would materially impact the accuracy and reliability of the results that are included in the database used for Mineral Resource and Mineral Reserve estimation.

Analytical work comparing various drilling campaigns and drilling types indicates potential down hole contamination in some of the wet Canplats RC drilling. This is discussed in more detail in Section 12.1.1.3. The suspect sample intervals were not used for the resource modeling for this Technical Report. This impacted about 2100m, or about 5%, of the Canplats drilling.

10.6.2 RGI Conclusion

It is the opinion of RGI that the 2018 drilling and sampling procedures for Camino Rojo drill samples by Orla are reasonable and adequate for the purposes of this Technical Report. RGI does not know of any drilling, sampling, or recovery factors related to 2018 drilling that would materially impact the accuracy and reliability of results that are included in the database used for Mineral Resource and Mineral Reserve estimation.

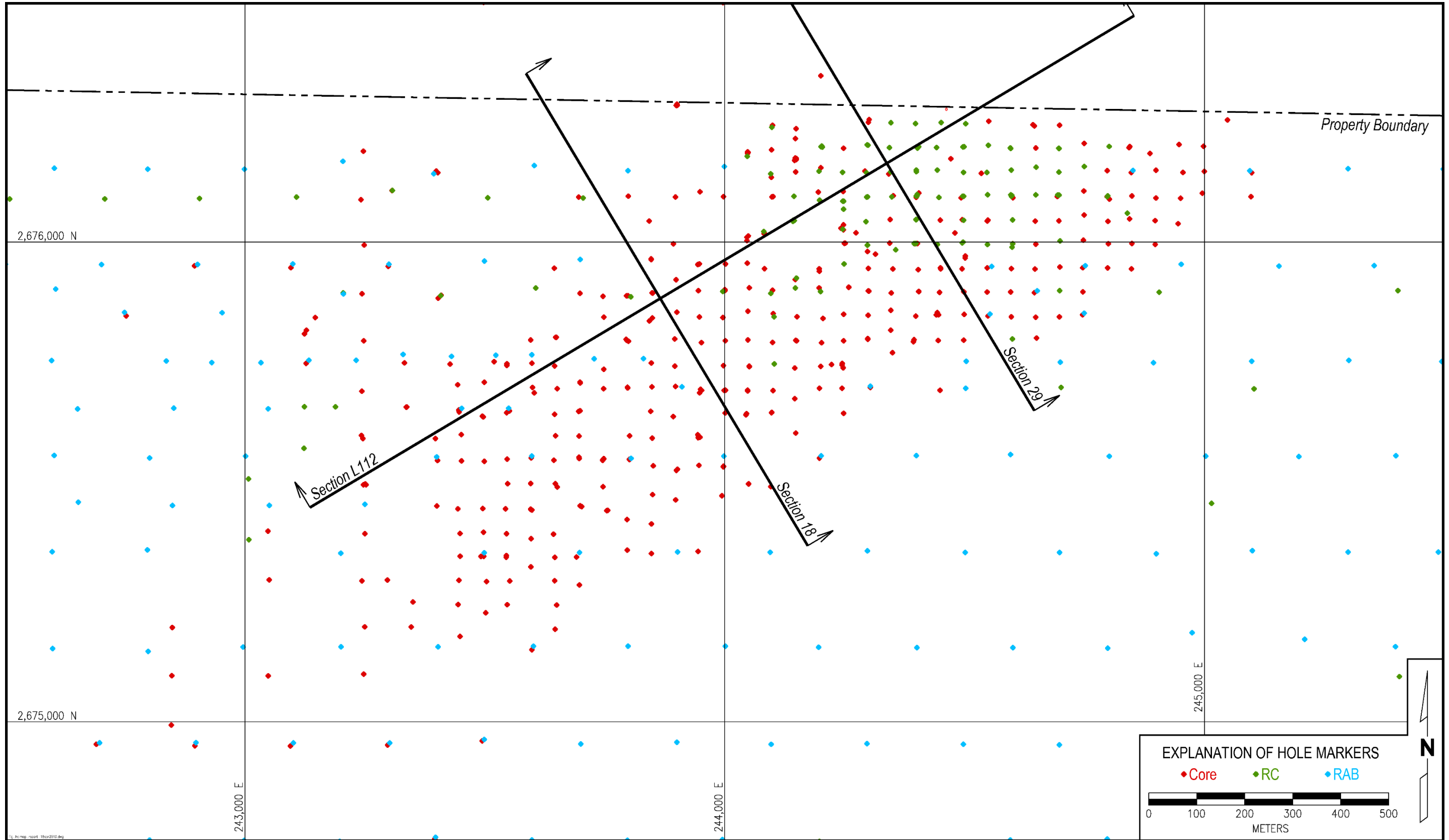

Figure 10.1 Drilling by Type, IMC 2019

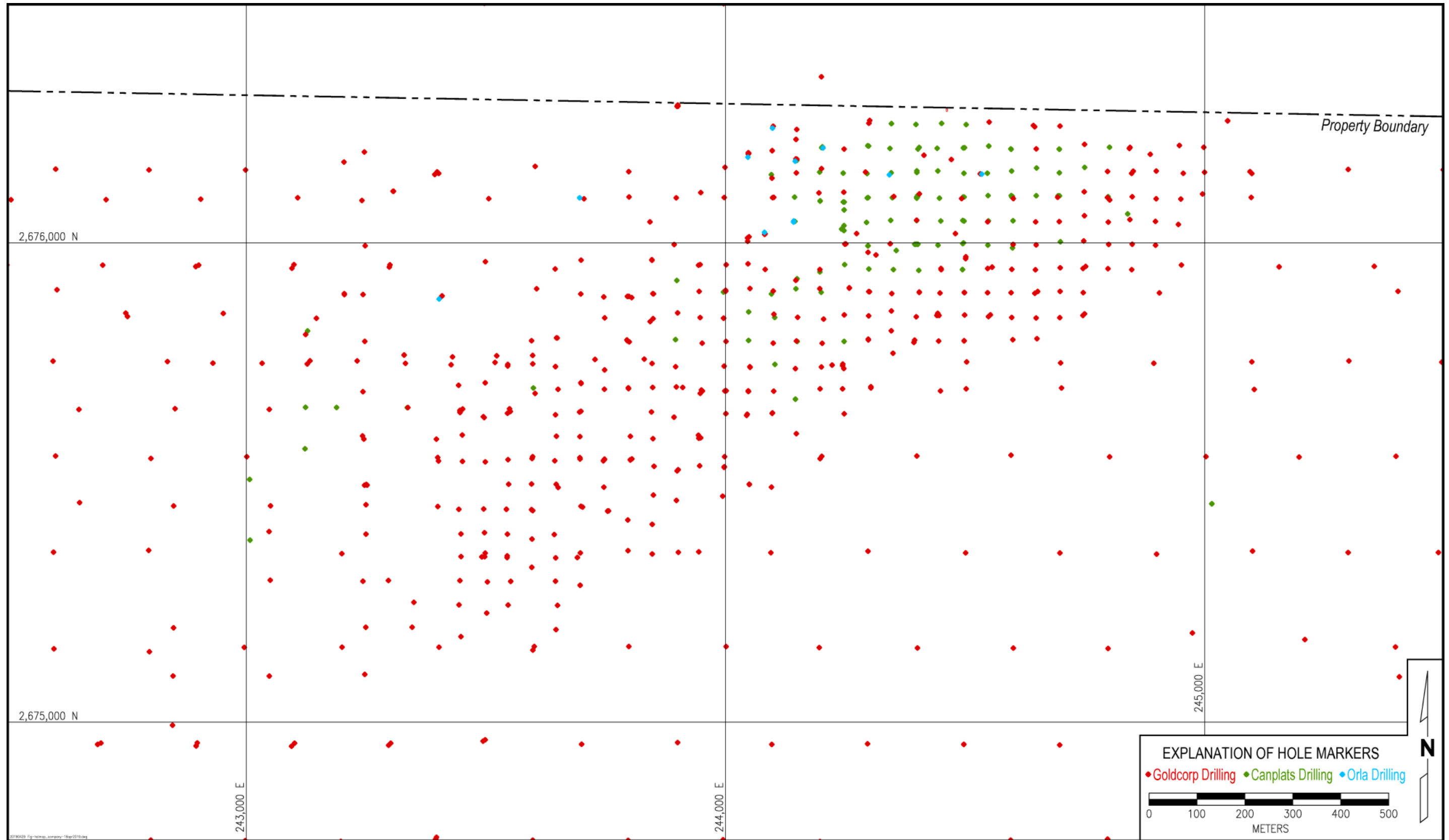

Figure 10.2 Drilling by Company, IMC 2019

11.0 SAMPLE PREPARATION, ANALYSES AND SECURITY

11.1 Sample Preparation

There has been no new drilling for Mineral Resource estimation purposes since the 2019 Technical Report and this section is the same as presented in the 2019 Technical Report. The sampling and analysis were supervised by the geological staff of Canplats for 2007 and 2008 drilling, by Goldcorp for 2011 through 2014 drilling, and by Orla for 2018 drilling.

ALS Chemex has been the primary assay laboratory used for the routine assaying of surface and drill samples for the Canplats, Goldcorp, and Orla drilling/sampling programs. All of the assays have been done at the ALS Chemex laboratory in North Vancouver, British Columbia, certified under ISO 9001: 2000, and 2008, and accredited under ISO 17025:2005. ALS Chemex is independent of each of Canplats, Goldcorp, and Orla.

The Canplats samples were prepared for assaying at the ALS Chemex sample preparation laboratory in Guadalajara, Mexico. Most of the Goldcorp samples were prepared at the ALS Chemex sample preparation laboratory in Zacatecas, Mexico. However, during 2013 and 2014 samples were also sent to the ALS Chihuahua facility and the ALS Guadalajara preparation lab as well as the Zacatecas facility. Orla samples were prepared at the ALS Chemex facility in Zacatecas.

Upon receipt at the sample preparation labs the samples were dried, crushed in their entirety to >70% passing a 2mm screen. The crushed material was riffle split to extract an approximate 250-gram sub-sample that was pulverized to >85% passing 75 microns in a disc pulveriser. This sample preparation procedure is the standard ALS Chemex "PREP-31" procedure. Each of the 250-gram pulps were riffle split into two sealed paper sample envelopes, with one split air-shipped to the ALS Chemex assay facility in North Vancouver. The second split was returned to the property for storage. The same sample preparation procedure was used for core and RC chips.

11.2 Analyses

The core and RC samples collected by Canplats and Goldcorp, and Orla, as well as the surface pit and trench samples collected by Canplats, were assayed with the same analytical methods and at the same laboratory, the ALS Chemex facility in North Vancouver, British Columbia. For gold, all were assayed using the Au-AA23 30-gram fire assay fusion, with Atomic Absorption finish. A total of 33 other elements were determined by four-acid sample digestion followed by Inductively Coupled Plasma Atomic Emission Spectrometry (ICP-AES). This is ALS Chemex method code ME-ICP61. The elements assayed by ICP-AES are Ag, Al, As, Ba, Be, Bi, Ca, Cd, Co, Cr, Cu, Fe, Ga, K, La, Mg, Mn, Mo, Na, Ni, P, Pb, S, Sb, Sc, Sr, Th, Ti, Tl, U, V, W, and Zn.

Over-limits for gold were automatically re-assayed with 30-gram fire assay fusion with gravimetric finish (method code Au-GRA21). Over-limits for silver, copper, zinc and lead were automatically performed by four acid digestion of the sample followed by analysis by ICP-AES. This is ALS Chemex method code ME-OG62 for ore grade samples.

RAB-style RC samples from 2011 to 2014 were analysed at ALS Chemex using method code ME-MS61m, which employs the same four-acid digestion, and a combination of ICP-AES, mass-spectrometry, and cold-vapour Atomic Absorption to determine 48 elements plus mercury. Most of the RAB holes are peripheral to the main deposit area.

11.3 QA/QC Programs

11.3.1 Canplats QA/QC Program

It is reported that the Canplats Quality Control/Quality Assurance (QA/QC) program was based on the insertion of control samples at a target rate of 5% to the assay laboratory (Blanchflower, 2009). A quality control sample was to be inserted randomly within every 20 consecutive samples, alternating between standard, blank or duplicate samples. The standard and blank samples were inserted into the sample sequence as the sample shipment was being readied. Duplicate samples were inserted into the sample sequence at the time of collection (Blanchflower, 2009). As reported by Blanchflower (2009) the final, compiled database for 2007 and 2008 drilling included 2,165 blanks and standards, and 1,078 field duplicates. However, relatively few of the Canplats QA/QC samples (about three holes) are included in the current database. IMC believes the Canplats drilling is adequately verified by the Goldcorp drilling results. Based on 5m composite there are 673 Canplats composites in 51 different holes that also have Goldcorp composites within 10m. The distributions of the gold values are comparable. This analysis is after the removal of potentially contaminated Canplats RC samples discussed in Section 12.1.1.3.

11.3.2 Goldcorp QA/QC Program

Goldcorp's QA/QC program included the use of blanks, standards and field duplicates for all drilling to monitor potential sample numbering issues and contamination during sample preparation, as well as analytical accuracy and precision. The control sample insertion rate was originally targeted at 7%, and Goldcorp personnel inserted all QA/QC samples during sample collection, prior to placing the samples in the storage area for shipment to the laboratory. A blank was inserted every 25 samples and consisted of fragments of unaltered calcareous siltstone and sandstone of the Caracol Formation, from a borrow pit near Tanque Nuevo, Zacatecas, approximately 60km northeast of Camino Rojo. For RC blanks the Caracol material was hand-crushed to coarse gravel size, and for core drilling blanks the material was broken into fragments similar to drill core size. Standards were inserted every 50 samples usually immediately following the blanks. Standards have included the commercial standards CDN-ME-15 and CDN-ME-16,

from CDN Resource Laboratories in Vancouver, B.C., and three in-house reference materials, PEN1850OX, PEN1850T and STDCR14-01, all prepared at SGS Minerales in Durango. The first two were prepared from bulk samples of oxide and mixed oxide-sulphide ore from Peñasquito and the latter from Camino Rojo drill core. Field duplicates were inserted every 100th sample, labelled with a “B” suffix to the original sample number. Field duplicates were two ¼’s of the same ½ piece of sawn core. A total of 10,583 control samples were inserted in 2011 through 2013, for a realized control insertion rate of just below 8%.

A comprehensive compilation and review of Goldcorp’s QA/QC program by Hamilton (2014c) determined that while adequate, the program had several aspects that could be significantly improved through a few simple and easy to implement changes including:

- At 8% the overall insertion rate was considered low and that a higher proportion of QA/QC samples, distributed more evenly, were needed.
- Over significant periods of time only a single standard had been used and that several standards should be used on a rotation basis.
- The ¼ core duplicate could not assess variability in the regular samples properly and that the full second half of core should be used instead.

Early in 2014 a new QA/QC protocol was adopted where a QA/QC material would be inserted every 10th sample for an improved insertion rate of 10%. Three standards were used in a rotation, alternating with blanks and duplicates such that every 80 samples two blanks, two ½ core duplicates and 4 standards were inserted into the sample sequence.

Goldcorp implemented procedures in 2012 for improved follow-up of QA/QC analytical data (Ristorcelli and Ronning, 2012). The project database manager was to review blank and standard assay results as new data was received and loaded into the project master assay table. Standards more than three deviations from the expected values and blanks with gold values greater than 0.020 g/t, or silver values greater than to 1.5 g/t, were reported to the project exploration manager and via email to ALS Chemex for investigation. The exploration manager, database manager and ALS Chemex QA/QC staff communicated to identify the cause of the elevated blank or unexpected standard result. Depending on the cause, the exploration manager ordered appropriate steps as necessary for re-assays, or submission of remaining sample splits for new assays, and instructed the database manager on any changes needed to the assay database.

The Goldcorp QA/QC samples were included in the database provided to IMC. IMC has reviewed this data, including developing some independent control charts. It is the opinion of IMC that the Goldcorp QA/QC program met or exceeded industry standards.

11.3.3 Orla QA/QC Program

Throughout the 2018 drilling campaign Orla implemented a quality assurance and quality control program appropriate for an exploration and resource evaluation program. Orla's QA/QC program included training of project geologists and drillers on proper sampling methods at the drill rig, field visits by the responsible Qualified Person, systematic insertion into the sample stream and assay of blank samples, standards, and duplicate samples.

Blank samples were of crushed unmineralized post-mineral volcanic rocks. During the 2018 drill program project geologists inserted blank samples into the sample stream at an interval of one blank sample every 50 samples on regular intervals. A total of 29 blanks were inserted into the sample stream and 19 of the blanks were preceded by a sample containing detectable gold. In 2 of these 19 cases, the blank sample also returned a detectable gold assay. The blank sample that was immediately preceded by the highest-grade drill sample, 5.57 ppm, yielded the highest measured gold concentration of 0.16 ppm. If it is assumed that the blank samples truly are "blank" and do not contain gold above the 0.005 ppm detection limit, then these data are consistent with a slight and immaterial amount of contamination during sample preparation. This possible error is not considered significant.

Standards were inserted into the sample stream every 50 samples. Five different standards of different gold grades were used. The standards were prepared and certified by CDN Resource Laboratories Ltd. of Canada and Rocklabs Ltd. of New Zealand. The standards were in the form of pulps and were inserted into the sample stream after the laboratory had completed its sample preparation. Standards ME1401, ME1414, OXC145, OXD127, and OXI121 were used. A comparison of standard assay results from ALS Chemex to the certified assay means for the standards indicates that the assays obtained during the 2018 drilling program are reliable.

Field duplicates were inserted into the sample stream at a ratio of one duplicate every 50 samples. Field duplicates consist of a ¼ rig split of the RC drilling chips collected from the same ½ split that yields the sample sent to the lab, or a ¼ sawn split of drill core. Field duplicates were submitted blind to the laboratory, i.e., the lab could not distinguish which samples were field duplicates. Duplicates were submitted as the 5th sample immediately following the original sample. A total of 31 field duplicates were analysed. The field duplicates show high variation compared to originals for both Au and Ag and 10% of rig split duplicates have greater than 60% absolute relative difference in Au assay and 47% absolute relative difference in Ag assay from originals. The variance in gold was further examined by segregating data by drilling method. Both RC and drillcore samples exhibit the same variances of Au.

The precision demonstrated by the rig split duplicates is outside of normal ranges observed for disseminated gold deposits. The data indicates the gold and silver distribution is heterogeneous

at a local scale. The assay data is adequate for resource estimation purposes, but the estimate of grade at any specific location or particular block within the model will be moderately uncertain, although the global estimate will be reliable.

Preparation duplicates are inserted into the sample stream at a ratio of one duplicate every 100 samples. A total of 15 preparation duplicates were analysed. Preparation duplicates have a low variation compared to originals. 90% of sample preparation duplicates have less than 22% absolute relative difference Au and less than 20% absolute relative difference Ag from originals. The precision demonstrated by the coarse reject duplicates is within normal ranges observed for gold deposits and the data indicates the sampling is reliable and adequate for resource estimation purposes.

Assay (lab) duplicates were inserted into the sample stream at a ratio of one duplicate every 100 samples. A total of 12 lab duplicates were analysed. Lab duplicates consist of a repeat analysis of an already prepared and analysed sample pulp. The pulp re-assays show low variance compared to the original assay for both Au and Ag and 90% of laboratory pulp duplicates have less than 13% absolute relative difference Au and less than 10% absolute relative difference Ag from originals. The precision demonstrated by the pulp re-assays is within normal ranges observed for gold deposits and the data indicates the sampling is reliable and adequate for resource estimation purposes.

Check assays from an independent lab of the same pulp assayed by ALS have not yet been performed. Bureau Veritas (BV) labs has performed independent assays on a second pulp prepared by ALS and sent out for independent assay for 64 samples. BV gold assays yielded a mean 11.9% higher than the ALS assays. Because the BV assays are of a second pulp, not the same pulp assayed by ALS, no conclusions can be drawn about the repeatability of assays between the labs. It is recommended that 3% of pulps assayed by ALS Chemex are sent to and assayed by another independent laboratory to verify results.

It is the opinion of RGI that Orla's QA/QC program was appropriate for a resource development drill program and the QA/QC program met or exceeded industry standards. Results of analyses of blank, standard, and duplicate samples verify that the analytical results of the 2018 drilling program are reliable and it is the opinion of RGI that the 2018 drillhole assay database is suitable for use for resource estimation.

11.4 Sample Security

11.4.1 Canplats and Goldcorp Sample Security

After collection in the field, the Canplats core and RC samples were transported by truck to a secure warehouse in San Tiburcio, a distance of about 5km. After each drill core sample was split in half by sawing and bagged, the sample bags were tied shut with non-slip plastic ties. The sample bags were then moved to a locked storage area in the core logging and storage facility controlled by the company geologists. Prior to shipping, several sample bags were placed into large woven nylon 'rice' bags, their contents were marked on each bag, and each bag was securely sealed.

The sample bags were delivered directly to the ALS Chemex assay laboratory in Guadalajara, Jalisco State, Mexico by company personnel.

During the Goldcorp tenure samples were transported from the field to a secure warehouse and logging area in San Tiburcio, usually twice a day, morning and late afternoon. Sealed individual sample bags of sawn core were loaded into numbered rice sacks which were tied closed and placed in the secure storage building each afternoon. Once or twice a week the sealed sacks were loaded into a delivery truck operated under contract to ALS Chemex and delivered to the preparation labs.

Orla took possession of the Goldcorp facility in San Tiburcio. As of this writing the core, many of the assay pulps, and the RC chip trays are stored at this facility. The facility is walled with locked gates.

It is the opinion of IMC that the sample preparation, analysis, QA/QC programs and sample security were adequate to ensure the reliability of the drilling database.

11.4.2 Orla Sample Security

During the 2018 drill campaign, at the end of each drill shift, Orla personnel moved RC cutting samples and drill core to Orla's secure, locked storage facilities in San Tiburcio. Samples for assay were packaged in shipping sacks and delivered directly to the ALS sample preparation facility in Zacatecas.

It is the opinion of RGI that the sample preparation, analysis, QA/QC programs and sample security were adequate to ensure the reliability of the 2018 drilling database.

12.0 DATA VERIFICATION

12.1 Resource Model Data

12.1.1 Canplats and Goldcorp Drill Data

12.1.1.1 Assay Data

IMC selected 20 holes at random from the Camino Rojo database and compared the database with original assay certificates. The holes were:

CR13-459D	CR11-289D	CR12-344D	CR11-332D
CR13-380D	CR13-428D	CR13-390D	CR13-422D
BCR-006	BCR-044	BCR-066	CR13-424D
CR11-266D	BCR-078	CRD-021	CR11-284D
BCR-011	BCR-019	CR11-305D	CR13-497D

The gold, silver, lead, and zinc assays in the database were compared with the certificates. The checked data amounted to about 7,623 assay intervals.

For gold there were minor discrepancies in the certificates versus the database for nine intervals; one in CR11-266D and eight in CR13-380D. The database and certificate values were similar, so the discrepancies are not material. There were also eight discrepancies for silver and zinc and seven discrepancies for lead in hole CR13-380D, generally in the same records as gold. This is an indication that a section of hole CR13-380D might have been re-assayed.

There were also 10 discrepancies for silver, lead, and zinc in hole BCR-019. They were the same 10 assay intervals. Again, the certificate and database values were similar, so the discrepancies are not material.

Based on the comparisons IMC concluded the database assay values are reliable.

12.1.1.2 Collar Locations

IMC also compared collar elevations of the drillholes with topography. The elevations were in very good agreement with the exception of 15 holes, mostly on one drill fence, at the south end of the drilling. The holes are not in the resource area and are not material for the present study.

Minera Camino Rojo personnel have also re-surveyed many of the drillhole collars to verify the original surveys. IMC believes the collar coordinates of the drillholes are accurate.

12.1.1.3 *Canplats RC Data*

A review of the RC drilling was done. In particular, a report by Mine Development Associates (MDA) dated June 8, 2011 and titled “Camino Rojo – A Comparison of Goldcorp and Canplats Drill Results” indicated potential issues with the Canplats RC drilling. The report concluded that a portion of the RC drilling that was considered wet was probably contaminated and should not be used for Mineral Resource estimates. Contamination in RC drilling occurs when material from higher in the hole falls downward and mixes with samples extracted from lower in the hole.

IMC conducted a comparison of the following four population sets based on pairing 5m composites:

- Goldcorp core versus all Canplats RC
- Goldcorp core versus dry Canplats RC
- Goldcorp core versus wet Canplats RC
- Canplats dry versus wet RC

There was a variable in the database (wet_rc) that classified the RC drilling into dry, humid, and wet. For the Canplats data there were 11,074 assay intervals classified as dry, 375 classified as humid, and 1,638 classified as wet. Humid and wet are lumped for this analysis. Generally, portions of holes are classified as humid or wet, not the entire hole. Also, the wet samples tend to be deeper in the holes for most occurrences. Based on a review of cross sections, most of the wet RC drilling is not in the constrained oxide pit developed for this Technical Report.

Additional analysis was done with decay analysis and visual review of the assays in the holes. Based on the analysis IMC decided the assay intervals marked as wet or humid for the following 16 holes are potentially contaminated and should not be used for resource modeling:

BCR-031	BCR-039	BCR-040	BCR-052
BCR-069	BCR-080	BCR-010	BCR-028
BCR-030	BCR-032	BCR-035	BCR-044
BCR-057	BCR-074	BCR-084	BCR-085

This impacted about 2100m, or about 5%, of the Canplats drilling.

It is noted that Goldcorp also drilled several RC holes, but they tend to be outside of the Mineral Resource area of interest for this Technical Report.

IMC is of the opinion that the Camino Rojo drillhole database is acceptable for Preliminary Economic Analysis, Prefeasibility and Feasibility level studies, after the deletion of the potentially contaminated RC samples.

12.1.2 Orla Drill Data

RGI conducted field reviews during the 2018 drill program to verify drilling and sampling techniques and drillhole collar locations. RGI reviewed: drill methods; drill core; Orla's drill logs; Orla's geologic and oxidation database; and Orla's geological interpretations and model. No discrepancies, inconsistencies, or geologically implausible interpretations were noted. RGI independently evaluated the drill sample assay data, including a comparison of the Project drillhole database against original assay certificates from the 2018 drill program. No unresolved discrepancies were noted and it is the opinion of RGI that the 2018 geologic and drillhole assay database is suitable for use in resource and reserve estimation and for the purpose of this Technical Report.

12.1.3 Historical Data Reviews

12.1.3.1 Canplats

Canplats Resource Corporation issued a Technical Report titled "Preliminary Assessment based on Report Titled 'Technical Assessment of Camino Rojo Project – Zacatecas Mexico'" with an amended date of November 30, 2009. The report was prepared by Minorex Consulting Ltd., an independent, qualified, consulting group. In Sections 11.0 (Drilling) and 14.0 (Verification) Minorex states that they were responsible for the compilation of the drilling database and that the data included in the database was verified by them.

Section 14.0 of the Canplats report also includes detailed description of the QA/QC program for the 2007/8 drilling campaign. In particular, GeoSparks Consulting based in Nanaimo, British Columbia, an independent consulting company, was retained to compile and review all the 2007 and 2008 QA/QC results. This review also included sending 152 samples to another laboratory for check assays. The GeoSparks report concluded that the final assay results for the 2007 and 2008 drilling were of high quality.

12.1.3.2 Goldcorp

During August 2012, M3 Engineering of Tucson, Arizona (M3) prepared a Pre-Feasibility Study report for the Camino Rojo Project for Goldcorp. The report was titled "Camino Rojo Project – Technical Report – Pre-Feasibility Study – Zacatecas, Mexico", dated August 17, 2012. This Technical Report was prepared in NI 43-101 format but it does not appear it was filed on SEDAR; Camino Rojo was probably not considered a material property for Goldcorp.

The resource block model for the M3 study was developed by Mine Development Associates (MDA) of Reno, Nevada. It is reported that MDA did a detailed audit of several aspects of the drilling data including collar locations, downhole deviation surveys, checks of the specific gravity measurements conducted by Goldcorp, and the analytical data. The report notes that MDA checked all the Canplats and Goldcorp assays against original assay certificates for gold, silver, copper, zinc and lead. It is also reported that very few discrepancies were noted in the data.

As discussed in Section 12.1.1.3, MDA also did analysis that indicated potential downhole contamination in some of the Canplats wet RC drilling.

In addition to IMC's and RGI's reviews, there has been considerable review of the Camino Rojo drilling data by companies that were independent of the owners. IMC is of the opinion that the Camino Rojo drillhole database is acceptable for Preliminary Economic Analysis, Prefeasibility and Feasibility level studies.

12.2 Metallurgical Test Data

KCA checked the metallurgical test procedures and results to ensure they met industry standards. Metallurgical sample locations were reviewed to ensure that there was material from throughout the resource area and that the samples were reasonably representative with regards to material type and grade with the material planned to be processed so as to support the selected process method and assumptions regarding recoveries and costs.

12.3 Site Visits by Qualified Persons

As detailed in Section 2.4, each of the Qualified Persons for this Technical Report visited the Camino Rojo property and, in regards to data verification, were provided the opportunity to review current and past drill programs, property details and other miscellaneous items in relation to the Camino Rojo Project. There was no limitation on the ability of the Qualified Persons to conduct the data verification procedures.

13.0 MINERAL PROCESSING AND METALLURGICAL TESTING

Historical metallurgical test work programs on the Camino Rojo Project were commissioned by the prior operators of the Project: Canplats (SGS, 2009; KCA 2010) and Goldcorp (KCA, 2012; KCA 2014, KCA, 2015; Blue Coast 2012, Hazen, 2014; SGS Vancouver, 2015). A confirmatory metallurgical test program was commissioned by Orla (KCA, 2019) to confirm the results and conclusions from the previous campaigns. The data analyzed in this section of the Technical Report are based on previous results as no new relevant metallurgical testing has been completed since the release of the 2019 Technical Report. Preliminary alkaline atmospheric oxidation pre-treatment work for transition and mixed sulphide material has also been performed (KCA, 2020); however, results from this work is not considered for estimating recoveries or reagent requirements for this Technical Report.

In total 107 column leach tests (85 on representative samples for the material types and pit area) and 164 bottle roll tests have been completed to date on the Camino Rojo ore body as well as physical characterization and preliminary flotation test work.

Selected test work and results from the programs carried out to-date for the Camino Rojo Project are summarized chronologically below and are referenced in this Technical Report. Although condensed, for the sake of completeness, as much relevant data as practical are presented here, as a significant amount of metallurgical work has been done. Sample locations for all column test work are presented in Figure 13.1.

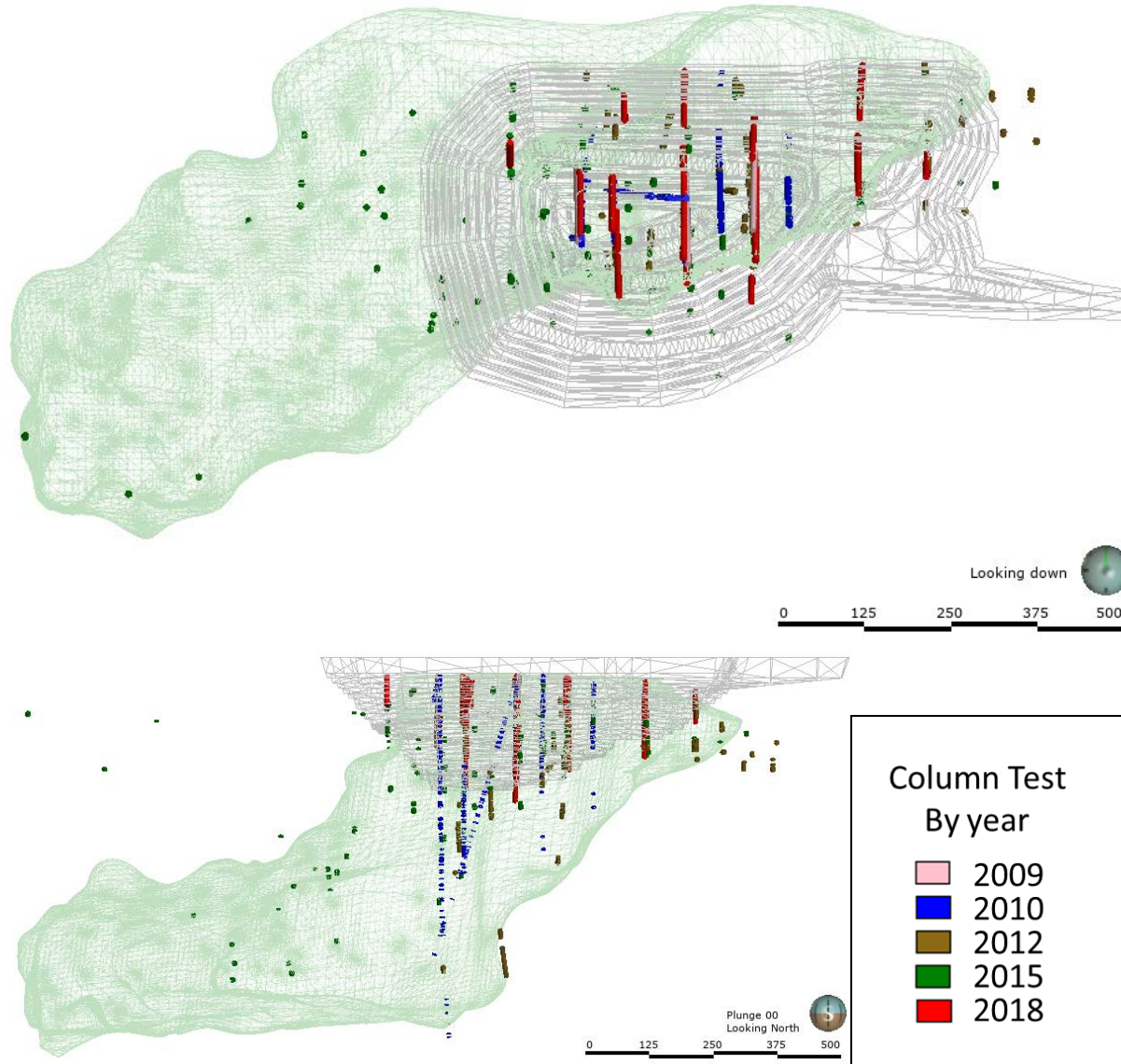

Figure 13.1 Column Leach Test Sample Locations (Orla, 2019)

13.1 Canplats (2009 & 2010)

Canplats commissioned SGS Mineral Services Minerals in Durango, Mexico to conduct bottle roll, column leach, and flotation tests in two programs on Camino Rojo drill core samples and in 2009 publicly disclosed results of 18 column leach tests, 61 bottle roll tests, and 35 flotation tests.

In 2010, Mine and Quarry Engineering Services, on behalf of Canplats, commissioned KCA to perform additional metallurgical test work based on material mineralization according to the geological and mineral interpretations at the time. Test work performed included cyanide shake tests on 569 individual samples and 16 composites, 16 column leach tests, as well as percolation and agglomeration tests.

13.1.1 SGS Mineral Services (2009)

Results for the 2009 SGS test program summarized herein are extracted from the Canplats 2009 technical report (Blanchflower, K.D., Kaye, C., and Steidtmann, H., 2009).

Composite samples for the first program by SGS were obtained from diamond drill cores of oxide and transition material. Tests performed during the first program included bottle roll, column leach and flotation. The second program used samples from diamond drill cores of oxide, sulphide and transition materials. Material from the second program was used for bottle roll and flotation tests. No mineralogy, bond work index and crusher abrasion index tests were performed.

13.1.1.1 SGS Mineral Services 2009 – Column Leach Tests

Column leach tests results are summarized in Table 13-1 and Table 13-2 for oxide and transition composites, respectively, and indicate that variations in crush sizes between 37mm and 9.5mm for oxide material have a negligible effect on gold recovery. Silver recoveries tended to increase as the crush size was reduced to 9.5mm. The effect of crush size on transition material was only evaluated on 2 samples and there were insufficient data to show any meaningful trends. In general, gold recovery was higher for oxide material than transition material. Silver recoveries were consistently higher in transition samples than in oxide samples. Ultimate gold and silver recoveries for oxide material were achieved between 40 and 50 days. Different recovery trends for gold and silver based on material classification (oxide or transition) were evident. At a 19mm crush size, modeling of recovery versus head grades indicated that at a 0.7 g/t Au head grade, a gold recovery of approximately 74% for oxide material and 69% for transition material was predicted. At a 14 g/t Ag head grade, column test results indicated a silver recovery of approximately 23% for oxide material and 28% for transition material.

**Table 13-1
Oxide Column Test Results - SGS Mineral Services 2009**

Column	Crush Size (mm)	Calculated Head Grade		Extraction		Consumption	
		Gold (g/t)	Silver (g/t)	Gold (%)	Silver (%)	NaCN (kg/T)	CaO (kg/T)
CRM-06-1	38	0.672	8.27	72.59	12.84	0.66	2.29
	19	0.603	9.36	73.31	14.91	0.87	3.34
	9.5	0.537	9.00	73.65	19.02	0.81	4.28
CRM-06-2/3	38	1.952	10.63	83.66	12.05	0.79	2.36
	19	1.794	11.51	86.60	21.23	0.99	2.81
	9.5	1.795	11.58	86.49	25.27	1.23	4.60
CRM-14-1	38	0.508	19.24	62.14	30.39	0.78	3.00
	19	0.486	18.01	64.14	32.29	0.62	3.30
	9.5	0.486	18.01	61.81	28.06	0.91	4.30
CRM-20-1	38	0.369	14.09	65.15	23.16	0.58	2.63
	19	0.338	17.94	78.08	23.21	0.55	2.31
	9.5	0.359	15.26	74.81	30.88	0.71	3.55

Table 13-2
Transition Column Test Results - SGS Mineral Services 2009

Column	Crush Size (mm)	Calculated Head Grade		Extraction		Consumption	
		Gold (g/t)	Silver (g/t)	Gold (%)	Silver (%)	NaCN (kg/T)	CaO (kg/T)
CRM-14-2	38	0.431	15.51	34.74	33.71	0.67	1.59
	19	0.446	13.63	36.35	38.95	0.61	1.44
	9.5	0.387	15.33	33.13	44.15	0.81	2.53
CRM-20-2	38	0.593	21.51	55.2	30.54	0.54	1.55
	19	0.585	28.58	62.39	31.74	0.47	1.48
	9.5	0.589	22.35	60.51	50.87	0.84	2.83

13.1.1.2 SGS Mineral Services 2009 – Bottle Roll Leach Tests

Coarse bottle roll tests at -25mm (1”), -12.5mm (1/2”) and -6.25mm (1/4”) along with finely ground bottle rolls at -70 Mesh and -140 Mesh were conducted on samples from CRM 06 Composites 1, 2 and 3, CRM 14-1 (oxide) and 14-2 (transition) composites and CRM 20-1 (oxide) and 20-2 (transition). Results from the bottle roll tests for CRM 06, CRM 14 and CRM 20 composites are presented in Table 13-3, Table 13-4 and Table 13-5, respectively.

Table 13-3
Bottle Roll Test Results CRM 06 Composites - SGS Mineral Services 2009

Composite	Size	Head Assay		Residue		Extraction	
		Au g/t	Ag g/t	Au g/t	Ag g/t	Au %	Ag %
1	25 mm	0.68	9.3	0.21	7.8	74%	14%
	12.5 mm"			0.22	8.2	72%	17%
	6.25 mm"			0.26	7.2	64%	20%
	70 Mesh			0.11	8	84%	44%
	140 Mesh			0.06	3	89%	67%
2	25 mm	2.64	20.7	0.39	15.2	77%	16%
	12.5 mm"			0.34	15.2	82%	25%
	6.25 mm"			0.26	13.3	85%	27%
	70 Mesh			0.21	11	87%	43%
	140 Mesh			0.18	10	89%	51%
3	25 mm	1.68	8.7	0.39	14.7	79%	5%
	12.5 mm"			0.35	10.5	83%	10%
	6.25 mm"			0.32	10.1	83%	11%
	70 Mesh			0.11	8	91%	44%
	140 Mesh			0.06		96%	

Table 13-4

Bottle Roll Test Results CRM 14 Composites - SGS Mineral Services 2009

Composite	Size	Head Assay		Residue		Extraction	
		Au g/t	Ag g/t	Au g/t	Ag g/t	Au %	Ag %
1	25 mm	0.48	20	0.17	14.4	65.3%	29.0%
	12.5 mm"			0.16	16.1	67.4%	31.6%
	6.25 mm"			0.17	12.2	67.7%	41.1%
	70 Mesh			0.12	7.0	72.3%	59.5%
	140 Mesh			0.17	11.0	70.2%	53.3%
2	25 mm	0.50	14.0	0.26	7.4	32.5%	37.8%
	12.5 mm"			0.29	8.6	32.7%	39.2%
	6.25 mm"			0.34	4.5	26.1%	59.6%
	70 Mesh			0.35	3.0	39.5%	76.8%
	140 Mesh			0.28	3.0	50.1%	79.9%

Table 13-5

Bottle Roll Test Results CRM 20 Composites - SGS Mineral Services 2009

Composite	Size	Head Assay		Residue		Extraction	
		Au g/t	Ag g/t	Au g/t	Ag g/t	Au %	Ag %
1	25 mm	0.39	19.7	0.16	16.0	62.6%	22.3%
	12.5 mm"			0.12	15.0	69.3%	23.4%
	6.25 mm"			0.12	13.0	71.2%	32.0%
	70 Mesh			0.13	8.0	70.1%	60.7%
	140 Mesh			0.09	8.0	81.5%	60.9%
2	25 mm	0.50	14.0	0.28	15.0	57.1%	33.8%
	12.5 mm"			0.24	13.0	62.4%	45.1%
	6.25 mm"			0.26	11.0	63.1%	55.6%
	70 Mesh			0.19	3.0	68.1%	86.7%
	140 Mesh			0.15	3.0	74.2%	85.8%

Bottle roll tests results show slightly increasing recoveries with finer crushing for all material types with silver recoveries being more sensitive to crush size than gold. Additionally, observed gold recoveries were significantly higher for the oxide composites compared to the transition composites and higher silver recoveries were observed in the transition composites compared to the oxide composites. Dissolution of gold and silver for the bottle roll tests was essentially complete after 48 hours.

13.1.1.3 SGS Mineral Services 2009 – Flotation Tests

Flotation tests were completed on CRM06 composites 1, 2 and 3, CRM14 composites 1 and 2 and CRM20 composites 1 and 2 at grind sizes of 65% -200 Mesh and 75% -200 Mesh as well as additional tests with a sulphidizing reagent Na₂S added. Additional Pb/Zn flotation tests were performed on 14 transition and sulphide composites from Camino Rojo drill holes CRD-005, CRD-009, CRD-012, CRD-013, CRD-015, CRD-022 and CRD-023 at grind sizes of 80% - 200 Mesh. A summary of the additional transition and sulphide samples is presented in Table 13-6.

Table 13-6
Transition & Sulphide Samples for Flotation Tests - SGS Mineral Services 2009

Hole Number	Metres		Samples Number		Composite Label	Comments
	from	to	from	to		
CRD-005	168	198	707003	707022	CRD-005-A	Transition
CRD-005	218	248	707036	707062	CRD-005-B	Transition
CRD-009	532	560	710714	710733	CRD-009-A	Sulphide
CRD-009	674	700	710808	710827	CRD-009-B	Sulphide
CRD-012	290	320	712263	712279	CRD-012-A	Sulphide
CRD-012	360	390	712306	712323	CRD-012-B	Sulphide
CRD-012	522	556	712407	712426	CRD-012-C	Sulphide
CRD-013	260	288	711343	711359	CRD-013-A	Transition
CRD-013	316	348	711378	711397	CRD-013-B	Sulphide
CRD-015	164	194	712819	712838	CRD-015-A	Transition
CRD-015	220	250	712859	712876	CRD-015-B	Transition
CRD-015	296	326	712906	712925	CRD-015-C	Sulphide
CRD-022	180	210	534479	534499	CRD-022-A	Transition
CRD-023	312	346	537533	537554	CRD-023-A	Sulphide

Results from the flotation test work indicated that the oxide material is not amenable to treatment by flotation and sulphidization did not improve the metallurgical response of this material. Flotation tests on sulphide samples produced some encouraging results for recoveries of base metals. Three tests recorded recoveries of lead to a lead rougher concentrate in excess of 85% while two others indicated recoveries in excess of 70%. Apart from these tests, however, lead grades were mostly low and considerable upgrading would be required to produce a marketable lead concentrate. Recoveries of zinc to a zinc rougher concentrate were mostly modest although two tests recorded recoveries in excess of 75%. Results indicated considerable upgrading of both zinc and lead rougher concentrates would be required to produce a marketable concentrate. Recoveries of gold and silver to the lead rougher concentrate ranged between 5% and 67% for gold and 7% and 78% for silver.

13.1.2 Kappes, Cassiday & Associates (2010)

Results for the 2010 KCA test program summarized herein are extracted from the KCA laboratory report titled “Camino Rojo Project Report on Metallurgical Test Work, April 2010” (KCA, 2010).

The 2010 metallurgical program was commissioned by Mine and Quarry Engineering Services (MQEs) on behalf of Canplats to investigate:

- The metallurgical response of the Camino Rojo material based on geological classifications (oxide, transition and sulphide);
- Spatial distribution within the known resource boundary;
- Effect of head grade on metallurgical recoveries; and
- The development of a geo-metallurgical model for the resource.

A total of 1,477 kg of sample material consisting of 569 individual $\frac{1}{4}$ to $\frac{1}{2}$ split core interval samples were submitted for test work. The individual core samples were crushed to a nominal - 38mm and then used to prepare 16 composite samples.

Metallurgical testing included cyanide shake tests on portions of the 569 individual core samples as well as the 16 composite samples, head analyses on the 16 composite samples including semi-quantitative multi-element and whole rock analysis and assays for carbon, sulphur, mercury, gold and silver, percolation and agglomeration test work and column leach test work.

13.1.2.1 Kappes, Cassiday & Associates (2010) – Head Analyses and Cyanide Shake Tests

Composite samples were prepared by combining sample intervals as specified by MQEs to generate 16 composite samples. Head analyses were completed for each composite sample and are presented in Table 13-7, Table 13-8 and Table 13-9 for gold and silver, carbon and sulphur and mercury and copper, respectively. Multi-element and whole rock analyses were also performed on each composite sample. Multi-element analysis shows arsenic concentrations ranging from 184 to 1031 ppm as well as elevated concentrations of zinc and lead.

Table 13-7
Head Analysis Gold & Silver – KCA 2010

KCA Sample No.	Composite	Average Assay, g/t Au	Average Assay, g/t Ag
42433	1	0.31	11.8
42434	2	0.83	18.5
42435	3	0.91	23.5
42436	4	0.37	8.7
42437	5	0.64	15.7
42438	6	0.98	23.8
42439	7	0.73	12.7
42440	9	0.61	18.5
42441	10	0.81	36.0
42442	11	0.55	12.7
42443	12	0.59	19.2
42444	14	0.59	16.2
42445	16	0.59	14.7
42446	17	0.72	27.1
42447	18	0.30	8.9
42448	21	0.24	11.1

Note: Silver analyses by 4-acid digestion with FAAS finish.

Note: Detection limit for silver by 4-acid digestion with FAAS finish is 0.2 g/t Au.

Table 13-8
Carbon & Sulphur Summary – KCA 2010

KCA Sample No.	Composite	Total Carbon, %	Total Sulphur, %	Sulphide Sulphur, %	Sulphate Sulphur, %
42433	1	0.86	0.13	0.01	0.12
42434	2	0.73	0.32	0.03	0.30
42435	3	0.35	0.32	0.05	0.28
42436	4	1.17	1.88	1.35	0.54
42437	5	1.06	2.42	1.81	0.62
42438	6	0.49	1.65	1.21	0.44
42439	7	1.60	3.61	2.91	0.70
42440	9	0.23	0.14	0.02	0.13
42441	10	0.08	0.24	0.02	0.21
42442	11	0.78	2.56	2.11	0.45
42443	12	0.44	2.01	1.52	0.49
42444	14	2.47	5.07	4.06	1.01
42445	16	0.40	0.16	0.01	0.15
42446	17	0.22	0.26	0.04	0.22
42447	18	1.48	3.22	2.52	0.70
42448	21	1.43	3.99	3.29	0.70

Note: The detection limit for carbon and sulphur by LECO analysis is 0.01%

Table 13-9
Mercury & Copper Summary – KCA 2010

KCA Sample No.	Composite	Total Mercury, mg/kg	Total Copper, mg/kg	Cyanide Soluble Copper, mg/kg	Cyanide Soluble Copper, %
42433	1	<0.05	65	28	43%
42434	2	<0.05	80	20	25%
42435	3	<0.05	114	31	27%
42436	4	<0.05	95	82	86%
42437	5	<0.05	89	68	76%
42438	6	<0.05	98	56	57%
42439	7	<0.05	150	86	57%
42440	9	<0.05	92	10	11%
42441	10	<0.05	118	28	24%
42442	11	<0.05	34	27	79%
42443	12	<0.05	80	62	78%
42444	14	<0.05	53	32	60%
42445	16	<0.05	65	21	32%
42446	17	<0.05	113	36	32%
42447	18	<0.05	72	56	78%
42448	21	<0.05	116	68	59%

Based on the head analysis, material grades ranged from 0.3 to 0.98 g/t Au and 8.7 to 36.0 g/t Ag. The composites did not show significant mercury or cyanide soluble copper.

Cyanide shake tests were conducted on portions of the 569 individual samples and the sixteen composite samples generated. Samples were pulverized to 80% passing 0.075mm and agitated with 5 g/L NaCN solution for 24 hours. Results from the cyanide shake tests on the composite samples are presented in Table 13-10.

Table 13-10
Composite Cyanide Shake Tests Results Summary – KCA 2010

KCA Sample No.	Composite	Type	Weighted Avg Calculated Head, g/t Au	Weighted Avg Calculated Head, g/t Ag	Weighted Avg Au Recov, %	Weighted Avg Ag Recov, %
42433	1	Oxide	0.35	9.13	61%	61%
42434	2	Oxide	0.86	13.33	77%	64%
42435	3	Oxide	1.25	21.19	75%	71%
42436	4	Transition	0.48	10.17	64%	56%
42437	5	Transition	0.75	17.64	66%	69%
42438	6	Transition	0.94	21.59	73%	80%
42439	7	Sulphide	0.49	16.27	53%	46%
42440	9	Oxide	0.73	16.25	70%	66%
42441	10	Oxide	0.88	24.91	77%	74%
42442	11	Trans / Sulphide	0.38	11.69	48%	67%
42443	12	Transition	0.54	17.60	50%	73%
42444	14	Sulphide	0.40	6.48	24%	38%
42445	16	Oxide	0.62	11.02	78%	60%
42446	17	Oxide	0.82	25.02	77%	67%
42447	18	Trans / Sulphide	0.29	7.06	52%	54%
42448	21	Sulphide	0.23	7.48	54%	41%

The cyanide shake tests show there is significant variability in metal recoveries with regards to material type with generally higher recoveries with oxide material.

13.1.2.2 Kappes, Cassiday & Associates (2010) – Column Leach Tests

Column leach tests were conducted on material from composites 1, 2, 3, 4, 5, 6, 9, 10, 11, 12, 16, 17 and 18 at -19mm with additional tests at -9.5mm on material from composites 2, 9 and 16. Results from the column tests are presented in Table 13-11.

Gold recoveries ranged from 36% to 80% with higher observed recoveries on oxide material and significantly lower recoveries on the transition/sulphide mix material. Only minor recovery improvements with finer crush size (-9.5mm vs. -19mm) were observed based on test results on the same composite at different crush sizes. Reagent consumptions were low to moderate with NaCN consumption ranging between 0.77 to 1.30 kg/t and lime consumptions around 1.0 kg/t.

Table 13-11
Column Leach Test Results on Composites – KCA 2010

Composite	Type	Crush Size, mm	Calculated Head, g/t Au	Extracted, % Au	Consumption NaCN, kg/t	Hydrated Lime Addition, kg/t
1	Oxide	19.0	0.33	63%	1.30	1.01
2	Oxide	19.0	0.77	70%	1.10	1.00
2	Oxide	9.5	0.78	73%	1.07	1.00
3	Oxide	19.0	0.96	75%	0.95	1.01
4	Transition	19.0	0.37	49%	0.95	1.00
5	Transition	19.0	0.64	57%	1.06	1.01
6	Transition	19.0	0.95	67%	1.06	1.01
9	Oxide	19.0	0.59	74%	1.16	1.01
9	Oxide	9.5	0.61	79%	1.34	1.01
10	Oxide	19.0	0.81	78%	1.30	1.01
11	Trans / Sulphide	19.0	0.44	36%	1.01	1.01
12	Transition	19.0	0.57	51%	1.28	1.01
16	Oxide	19.0	0.60	78%	1.08	1.01
16	Oxide	9.5	0.58	79%	0.98	1.01
17	Oxide	19.0	0.83	80%	0.77	1.00
18	Trans / Sulphide	19.0	0.27	41%	0.90	1.00
Average		19	0.63	63%	1.07	1.01
Average		9.5	0.66	77%	1.13	1.01

13.2 Goldcorp (2012-2015)

Between 2012 and 2015, Goldcorp carried out several metallurgical programs on oxide, sulphide and transition material. This work was performed by several different metallurgical testing groups including KCA, Blue Coast Research Metallurgy in Parksville, B.C., and Hazen Research in Golden, CO.

KCA completed three separate test programs for Goldcorp between 2012 and 2015 including column leach tests, agglomeration and percolation tests, bottle roll tests and cyanide shake tests.

The column tests were completed on composite samples of split core by material types and lithologies. The 2012 program included 28 column tests on 14 different composites by pit oxidation level and material type. The 2014 program included 68 direct and carbon in leach (CIL) bottle leach tests on cut and broken core intervals. The 2015 program included 26 column tests on 13 different composites by lithology.

The Blue Coast Research Metallurgy program consisted of a variability study, small scale gravity tests, and a flotation flowsheet development. The variability program subjected 98 samples to small-scale bench flotation, small-scale leach testing, and small-scale gravity recovery tests. Flotation flowsheet development testing was conducted on three bulk sulphide composites: one from the Represa zone and two from the West Extension.

The Hazen Research test program included grinding, flotation, and cyanide leaching studies of sulphide and transitional material on some 112 composites.

13.2.1 Kappes, Cassiday & Associates (2012)

Results for the 2012 KCA test program summarized herein are extracted from the KCA laboratory report titled “Camino Rojo Project Report on Metallurgical Test Work, May 2012” (KCA, 2012).

The 2012 KCA test program was conducted on half split HQ core material which was used to generate 14 composite samples. Core intervals received were sorted according to zone and oxidation class as requested by Goldcorp. Each composite was utilized for head analyses, bottle roll leach testing, agglomeration testing and column leach testing.

13.2.1.1 Kappes, Cassiday & Associates (2012) - Head Analyses

Head analyses were completed on each composite sample. Assays for gold and silver are presented in Table 13-12. Quantitative assays for carbon and sulphur and mercury and copper were also completed and are presented in Table 13-13 and Table 13-14, respectively. Semi-quantitative assays by means of ICAP-OES for multi-element and whole rock analyses were performed.

Table 13-12
Head Analysis Gold & Silver– KCA 2012

KCA Sample No.	Description	Average Assay, g Au/MT	Average Assay, g/t Ag	Weighted Avg. Head Assay ¹ , g Au/MT	Weighted Avg. Head Assay ¹ , g/t Ag
62401	Composite 1, Central-Oxide	0.350	13.75	0.361	13.38
62402	Composite 6, East-Oxide	0.490	9.29	0.510	9.21
62403	Composite 10, West-Oxide	1.875	11.65	2.551	11.38
62404	Composite 2, Central-Transition	0.468	13.71	0.508	12.05
62405	Composite 3, Central-Transition	0.501	21.00	0.489	18.53
62406	Composite 4, Central-Transition	0.950	25.41	0.991	22.67
62407	Composite 7, East-Transition	0.459	14.30	0.538	13.69
62408	Composite 8, East-Transition	0.799	25.51	0.818	22.59
62409	Composite 9, East-Transition	0.566	9.39	0.582	8.69
62410	Composite 11, West-Transition	0.655	10.01	0.641	8.62
62411	Composite 12, West-Transition	0.345	17.31	0.420	14.77
62412	Composite 13, West-Transition	0.492	12.60	0.517	12.40
62413	Composite 5, Central-Sulphide	0.434	5.90	0.406	5.47
62414	Composite 14, West-Sulphide	0.405	8.14	0.387	6.80

Table 13-13
Head Analysis Carbon & Sulphur– KCA 2012

KCA Sample No.	Description	Total Carbon, %	Total Sulphur, %	Sulphide Sulphur, %	Sulphate Sulphur, %
62401	Composite 1, Central-Oxide	0.32	0.18	0.01	0.17
62402	Composite 6, East-Oxide	0.76	0.22	0.01	0.21
62403	Composite 10, West-Oxide	0.51	0.25	0.01	0.24
62404	Composite 2, Central-Transition	1.09	1.93	1.42	0.51
62405	Composite 3, Central-Transition	1.03	4.42	3.48	0.93
62406	Composite 4, Central-Transition	0.34	1.77	1.37	0.40
62407	Composite 7, East-Transition	1.44	0.62	0.23	0.39
62408	Composite 8, East-Transition	0.86	1.33	0.90	0.43
62409	Composite 9, East-Transition	2.02	0.88	0.47	0.41
62410	Composite 11, West-Transition	1.05	3.22	2.55	0.67
62411	Composite 12, West-Transition	1.19	2.41	1.83	0.58
62412	Composite 13, West-Transition	1.15	0.52	0.22	0.31
62413	Composite 5, Central-Sulphide	1.69	3.55	2.87	0.69
62414	Composite 14, West-Sulphide	1.55	3.78	2.78	0.99

Table 13-14
Head Analysis Mercury & Copper– KCA 2012

KCA Sample No.	Description	Total Mercury, mg/kg	Total Copper, mg/kg	Cyanide Soluble Copper*, mg/kg	Cyanide Soluble Copper, %
62401	Composite 1, Central-Oxide	<0.05	161	8.13	5%
62402	Composite 6, East-Oxide	<0.05	165	3.33	2%
62403	Composite 10, West-Oxide	<0.05	99	7.46	8%
62404	Composite 2, Central-Transition	<0.05	115	69.05	60%
62405	Composite 3, Central-Transition	<0.05	153	82.85	54%
62406	Composite 4, Central-Transition	<0.05	102	46.20	45%
62407	Composite 7, East-Transition	<0.05	97	47.30	49%
62408	Composite 8, East-Transition	<0.05	69	51.70	75%
62409	Composite 9, East-Transition	<0.05	78	41.70	53%
62410	Composite 11, West-Transition	<0.05	97	58.35	60%
62411	Composite 12, West-Transition	<0.05	132	74.75	57%
62412	Composite 13, West-Transition	<0.05	103	51.50	50%
62413	Composite 5, Central-Sulphide	<0.05	77	32.30	42%
62414	Composite 14, West-Sulphide	<0.05	75	30.45	41%

*Note: Average of two (2) splits

13.2.1.2 Kappes, Cassiday & Associates (2012) – Bottle Roll Leach Tests

Cyanide bottle roll tests at 80% passing 0.075mm were performed on a portion of each sample and were run for 96 hours. Sodium cyanide was maintained at 1.0 g/L solution and a pH of 11.0 was maintained by adding hydrated lime.

Additional bottle roll tests were then completed on each composite which had an initial gold extraction of less than 20% including composites 2, 7, 9 and 12. These additional tests were performed with the same parameters with increased sodium cyanide concentrations of 5.0 g/L solution.

Bottle roll leach test results are presented in Table 13-15 for gold and Table 13-16 for silver.

Based on the bottle roll test results, oxide sample recoveries ranged between 71% and 91% for gold and 18% and 61% for silver. Transition recoveries ranged between 0% and 77% for gold and 37% to 93% for silver. Sulphide recoveries ranged between 0% and 16% for gold and 28% to 40% for silver.

The bottle roll test results indicate that the oxide samples are amenable to cyanide leaching for recovery of gold with lower recoveries for silver. Recoveries for transition material are highly variable for gold with good recoveries for silver. Sulphide samples are not amenable to cyanide

leaching for the recovery of gold and leaching of sulphides results in relatively low recoveries for silver. Increased cyanide concentrations resulted in higher cyanide consumptions with minor to no recovery improvements for gold ranging from 0% to 4% and silver recovery improvements ranging from 0% to 11%.

Table 13-15
Bottle Roll Leach Tests Summary, Gold– KCA 2012

KCA Sample No.	Description	Target NaCN, g/L	Calculated Head, g/t Au	Extracted, g/t Au	Avg. Tails, g/t Au	Bottle Roll Au Extracted, %	Leach Time, hours	Consumption NaCN, kg/t	Addition Ca(OH) ₂ , kg/t
62401	Composite 1, Central-Oxide	1	0.363	0.259	0.104	71%	96	0.33	2.50
62402	Composite 6, East-Oxide	1	0.505	0.387	0.118	77%	96	0.19	2.00
62403	Composite 10, West-Oxide	1	1.851	1.680	0.171	91%	96	0.33	2.00
62404	Composite 2, Central-Transition	1	0.458	0.016	0.442	4%	96	0.66	1.50
62404	Composite 2, Central-Transition	1	0.519	0.047	0.472	9%	96	0.74	1.50
62404	Composite 2, Central-Transition	5	0.535	0.062	0.473	12%	96	1.47	1.50
62405	Composite 3, Central-Transition	1	0.516	0.113	0.403	22%	96	1.21	2.00
62406	Composite 4, Central-Transition	1	0.741	0.503	0.238	68%	96	0.54	2.00
62407	Composite 7, East-Transition	1	0.425	0.000	0.425	0%	96	0.52	2.00
62407	Composite 7, East-Transition	1	0.523	0.016	0.507	3%	96	0.48	2.00
62407	Composite 7, East-Transition	5	0.514	0.031	0.483	6%	96	1.08	2.00
62408	Composite 8, East-Transition	1	0.656	0.047	0.609	7%	96	0.73	2.00
62409	Composite 9, East-Transition	1	0.564	0.000	0.564	0%	96	0.66	2.00
62409	Composite 9, East-Transition	1	0.575	0.032	0.543	6%	96	0.46	2.00
62409	Composite 9, East-Transition	5	0.572	0.032	0.540	6%	96	0.84	2.00
62410	Composite 11, West-Transition	1	0.582	0.130	0.453	22%	96	0.57	1.50
62411	Composite 12, West-Transition	1	0.322	0.000	0.322	0%	96	0.91	2.50
62411	Composite 12, West-Transition	1	0.407	0.016	0.391	4%	96	1.20	2.50
62411	Composite 12, West-Transition	5	0.400	0.016	0.384	4%	96	1.96	2.00
62412	Composite 13, West-Transition	1	0.486	0.373	0.112	77%	96	0.30	1.50
62413	Composite 5, Central-Sulphide	1	0.435	0.047	0.387	11%	96	0.75	2.50
62413	Composite 5, Central-Sulphide	1	0.525	0.062	0.463	12%	96	0.72	2.00
62413	Composite 5, Central-Sulphide	5	0.504	0.079	0.425	16%	96	1.99	2.00
62414	Composite 14, West-Sulphide	1	0.362	0.000	0.362	0%	96	0.98	1.50
62414	Composite 14, West-Sulphide	1	0.381	0.000	0.381	0%	96	0.85	1.50
62414	Composite 14, West-Sulphide	5	0.399	0.000	0.399	0%	96	2.34	1.50

Table 13-16
Bottle Roll Leach Tests Summary, Silver– KCA 2012

KCA Sample No.	Description	Target NaCN, g/L	Calculated Head, g/t Ag	Extracted, g/t Ag	Avg. Tails, g/t Ag	Ag Extracted, %	Leach Time, hours	Consumption NaCN, kg/t	Addition Ca(OH) ₂ , kg/t
62401	Composite 1, Central-Oxide	1	11.91	7.21	4.70	61%	96	0.33	2.50
62402	Composite 6, East-Oxide	1	10.09	1.8	8.30	18%	96	0.19	2.00
62403	Composite 10, West-Oxide	1	10.06	3.17	6.89	32%	96	0.33	2.00
62404	Composite 2, Central-Transition	1	8.79	7.69	1.10	88%	96	0.66	1.50
62404	Composite 2, Central-Transition	1	12.55	9.00	3.55	72%	96	0.74	1.50
62404	Composite 2, Central-Transition	5	13.92	10.01	3.91	72%	96	1.47	1.50
62405	Composite 3, Central-Transition	1	19.33	14.84	4.49	77%	96	1.21	2.00
62406	Composite 4, Central-Transition	1	26.68	24.78	1.90	93%	96	0.54	2.00
62407	Composite 7, East-Transition	1	12.31	8.20	4.11	67%	96	0.52	2.00
62407	Composite 7, East-Transition	1	14.15	8.35	5.79	59%	96	0.48	2.00
62407	Composite 7, East-Transition	5	13.46	9.27	4.00	70%	96	1.08	2.00
62408	Composite 8, East-Transition	1	17.49	15.29	2.19	87%	96	0.73	2.00
62409	Composite 9, East-Transition	1	6.97	2.57	4.41	37%	96	0.66	2.00
62409	Composite 9, East-Transition	1	6.85	2.76	4.10	40%	96	0.46	2.00
62409	Composite 9, East-Transition	5	7.27	3.57	3.70	49%	96	0.84	2.00
62410	Composite 11, West-Transition	1	8.28	5.98	2.30	72%	96	0.57	1.50
62411	Composite 12, West-Transition	1	13.54	9.32	4.22	69%	96	0.91	2.50
62411	Composite 12, West-Transition	1	16.12	11.40	4.71	71%	96	1.20	2.50
62411	Composite 12, West-Transition	5	17.15	13.03	4.11	76%	96	1.96	2.00
62412	Composite 13, West-Transition	1	11.91	9.93	1.99	83%	96	0.30	1.50
62413	Composite 5, Central-Sulphide	1	4.64	1.44	3.21	31%	96	0.75	2.50
62413	Composite 5, Central-Sulphide	1	5.67	2.07	3.60	37%	96	0.72	2.00
62413	Composite 5, Central-Sulphide	5	6.33	2.44	3.89	39%	96	1.99	2.00
62414	Composite 14, West-Sulphide	1	7.09	1.98	5.11	28%	96	0.98	1.50
62414	Composite 14, West-Sulphide	1	7.49	2.59	4.90	35%	96	0.85	1.50
62414	Composite 14, West-Sulphide	5	8.40	3.40	5.01	40%	96	2.34	1.50

13.2.1.3 *Kappes, Cassiday & Associates (2012) – Column Leach Test Work*

Column leach tests were conducted on each composite at crush sizes of 100% passing 25mm and 12.5mm. Columns were leached for 113 days using a dilute sodium cyanide solution. Column leach test results are presented in Table 13-17.

For the oxide material the column tests showed that an average of 71% of the contained gold could be extracted from the material when crushed to 100% passing 25 millimetres with no additional extraction at 100% passing 12.5mm. The transition material showed an average recovery of 31% of the contained gold at 100% passing 25 millimetres and 30% at 100% passing 12.5 millimetres. Sulphide material recoveries ranged between 6% and 17% of the contained gold with very little recovery difference at 100% passing 25 millimetres and 100% passing 12.5 millimetres. Silver recoveries were generally higher with finer crushing. Reagent consumptions were low to moderate with an overall average NaCN consumption of 0.77 kg/t material and lime consumption of 2.03 kg/t material.

Table 13-17
KCA 2012 Summary of Column Leach Test Results by Material Type

Description	Crush Size, mm	Calculated Head, g/t Au	Extracted, % Au	Calculated Head, g/t Ag	Extracted, % Ag	Calculated Tail P ₈₀ Size, mm	Consumption NaCN, kg/t	Addition Hydrated Lime, kg/t
Composite 1, Central-Oxide	25.0	0.376	67%	13.07	15%	19.0	1.41	2.04
Composite 1, Central-Oxide	12.5	0.390	68%	15.37	19%	9.19	1.23	2.04
Composite 6, East-Oxide	25.0	0.573	62%	11.20	1%	17.8	1.08	2.01
Composite 6, East-Oxide	12.5	0.527	61%	13.62	2%	9.04	1.05	2.04
Composite 10, West-Oxide	25.0	2.031	83%	10.74	3%	17.8	0.18	2.03
Composite 10, West-Oxide	12.5	2.130	84%	13.24	2%	9.47	0.41	2.02
Composite 2, Central-Transition	25.0	0.484	28%	13.14	36%	18.5	0.44	2.03
Composite 2, Central-Transition	12.5	0.482	23%	15.03	41%	9.75	0.57	2.02
Composite 3, Central-Transition	25.0	0.484	26%	16.98	37%	17.9	0.56	2.03
Composite 3, Central-Transition	12.5	0.479	30%	18.26	45%	9.37	0.54	2.03
Composite 4, Central-Transition	25.0	1.448	40%	26.62	37%	18.5	0.59	2.02
Composite 4, Central-Transition	12.5	1.263	51%	29.05	49%	9.19	0.77	2.03
Composite 7, East-Transition	25.0	0.518	25%	14.63	43%	16.0	0.76	2.04
Composite 7, East-Transition	12.5	0.553	15%	16.97	46%	8.87	0.67	2.04
Composite 8, East-Transition	25.0	0.867	28%	21.07	42%	18.2	0.62	2.03
Composite 8, East-Transition	12.5	0.821	26%	23.74	52%	9.25	0.58	2.04
Composite 9, East-Transition	25.0	0.592	12%	11.36	29%	17.1	0.68	2.03
Composite 9, East-Transition	12.5	0.679	9%	11.07	33%	8.91	1.00	2.03
Composite 11, West-Transition	25.0	0.652	33%	10.02	36%	17.3	0.75	2.03
Composite 11, West-Transition	12.5	0.658	30%	11.17	35%	9.26	0.79	2.04
Composite 12, West-Transition	25.0	0.454	17%	19.37	41%	17.6	0.94	2.04
Composite 12, West-Transition	12.5	0.401	18%	19.70	41%	9.73	1.30	2.04
Composite 13, West-Transition	25.0	0.532	70%	10.21	22%	17.1	0.65	2.04
Composite 13, West-Transition	12.5	0.575	70%	15.46	26%	8.38	0.87	2.03
Composite 5, Central-Sulphide	25.0	0.446	8%	8.25	11%	17.8	0.86	2.02
Composite 5, Central-Sulphide	12.5	0.410	6%	6.42	17%	9.56	0.69	2.03
Composite 14, West-Sulphide	25.0	0.429	17%	5.31	14%	17.6	0.81	2.03
Composite 14, West-Sulphide	12.5	0.421	18%	4.62	18%	9.15	0.64	2.04
Average, Oxide	25.0	0.993	71%	14.50	6%	18.2	0.89	2.03
Average, Oxide	12.5	1.016	71%	11.67	8%	9.2	0.90	2.03
Average, Transition	25.0	0.670	31%	17.58	36%	17.6	0.67	2.03
Average, Transition	12.5	0.657	30%	15.93	41%	9.2	0.79	2.03
Average, Sulphide	25.0	0.438	13%	10.94	17%	17.7	0.84	2.03
Average, Sulphide	12.5	0.416	12%	6.78	18%	9.4	0.67	2.04

13.2.2 Blue Coast Research Metallurgy (2012-2013)

Results for the 2014 Blue Coast test program summarized herein are extracted from the Blue Coast Research report titled “Camino Rojo Final Report, March 2014” (Blue Coast, 2014).

A test work program was undertaken in 2012/2013 at Blue Coast Research Metallurgy (“Blue Coast Research”) in Parksville, B.C. This program consisted of a variability study, a small gravity program, and a flotation flowsheet development component (Blue Coast Research Ltd., 2014). Tests were completed using four samples selected to obtain information from a high oxidation and low oxidation sample from both the west and east zones of the deposit.

The variability program subjected 98 samples to small-scale bench flotation, small-scale leach testing, and small-scale gravity recovery tests. Flotation flowsheet development testing was conducted on three bulk sulphide composites: one from the central part of the deposit and two from the western part.

Blue Coast Research performed nine single-pass gravity recoverable gold (“GRG”) tests on different samples from various locations in the Camino Rojo deposit, both in the Represa and in the West Extension areas. A single extended GRG test was performed on a sulphide sample from the western part of the deposit (WE MC1). The results of these tests demonstrated gold recoveries greater than 20% at nominal primary grind feed sizes with mass pulls averaging 2%. These results suggest that concentration of gold by an initial gravity process is a viable option for sulphide material. No subsequent gravity work has been conducted to date.

Very little transitional material was tested at Blue Coast Research; the majority of the test work completed was performed on sulphide material from the western part of the deposit. Flowsheet development work conducted at Blue Coast Research formed the basis for understanding the processing options for the Camino Rojo sulphide deposit.

A full mineralogical analysis was performed on several samples during the Feasibility Study. The results of the QEMSCAN sulphide mineralogy indicated that the sphalerite was relatively coarse-grained, being well-liberated (having a 40% release size) well above 100 microns. Galena appeared finer-grained, being well-liberated at 90 microns.

Gold mineralogy was undertaken using both optical and D-SIMS techniques. Results indicated that gold was significantly linked to both pyrite and arsenopyrite. Higher gold values were associated with higher arsenic values.

Results from the Blue Coast Research Tests are presented in Table 13-18, Table 13-19 and Table 13-20.

Table 13-18
Summary of Flotation Composite Feed Grades

Composite	Au (g/t)	Ag (g/t)	Zn%	Pb%
WE MC1	1.19	10.8	0.31	0.10
WE MC2	0.89	8.6	0.26	0.08

Table 13-19
Lead Flotation Concentrate Grades

Composite	Au (g/t)	Ag (g/t)	Zn%	Pb%
WE MC1	185	2062	0.3	28.00
WE MC2	236	2094	9	36

Table 13-20
Zinc Flotation Concentrate Grades

Composite	Au (g/t)	Ag (g/t)	Zn%	Pb%
WE MC1	17	112	41	0.50
WE MC2	9	125	43	0.7

13.2.3 Hazen Research (2014)

Results for the 2014 Hazen Research test program summarized herein are extracted from the Hazen report titled “Camino Rojo Variability, May 2014” (Hazen, 2014).

Hazen Research was commissioned to conduct grinding, flotation, and cyanide leaching studies of sulphide and transitional material. Some 112 composites were tested. Standard flotation methods yielded recoveries of ~90% Au, 74% to 81% Ag, 83% to 90% Zn, and 82% to 91% Pb for sulphide material, and recoveries of 60% to 67% Au, 56% to 63% Ag, 35% Zn, and 48% Pb for transition material (Hazen Research Inc., 2014).

13.2.4 Comminution Testing

Comminution testing occurred at SGS Vancouver in 2015 (SGS Canada Inc., 2015). Material for testing was sourced from the Camino Rojo site directly as well as from an existing stockpile of

samples being stored at Hazen. From these two sources, a total of 23 half HQ composites and 2 full PQ composites were selected for testing. The HQ samples were selected based on 4 spatial quadrants, alteration, and oxidation. The PQ samples were selected based on their respective oxidation levels which included one near sulphide composite and one highly oxidized composite. JK Drop Weight (Axb), SMC, Abrasion Index (Ai), Crusher Work Index (CWI), Bond Ball Work Index (BWi), Bond Rod Work Index (RWi), SPI, Point Load Index, and Unconfined Compressive Strength (UCS) tests were performed. It should be noted that only two relevant crusher work indices were obtained from testing data as shown in the summary of results in Table 13-21 below.

**Table 13-21
Comminution Test Results Summary**

	Axb	SPI (min)	Ai (g)	CWi* (kWh/t)	BWi (kWh/t)	RWi (kWh/t)	UCS* (kN)	IS50 (Mpa)
Mean	38.9	99.8	0.123		14.4	15.9		7.48
Min	25.6	34.4	0.017	9.4	8.5	10.8	251.3	3.82
Max	68.2	145.9	0.276	10.5	19.4	19.3	522.3	15.35
RSD%	21.8	29.2	73.7		21.2	15.0		43.9

Additionally, comminution results are provided by alteration type in Table 13-22. These alterations are: Pyrite-Carbonate (PC), Incipient Potassic Hornfels (IH), and Potassic Hornfels (HF). As indicated in the table, “S” represents Sulphide and “T” represents Transition.

**Table 13-22
Comminution Test Results by Alteration Type**

	Axb	SPI (min)	Ai (g)	BWi (kWh/t)	RWi (kWh/t)	IS50 (Mpa)
PC (S)	41.6	93.0	0.061	12.8	14.4	6.07
PC (T)	50.5	57.2	0.024	9.6	12.1	4.78
IH (S)	29.7	141.2	0.136	16.8	18.6	7.93
IH (T)	40.7	92.0	0.061	13.2	15.3	5.18
HF (S)	32.1	120.1	0.233	17.6	18.2	13.46
HF (T)	39.1	99.4	0.200	16.2	16.7	6.89

13.2.5 Kappes, Cassiday & Associates (2014 & 2015)

Results for the 2014 and 2015 KCA test programs summarized herein are extracted from the KCA laboratory reports titled “Camino Rojo Project Report of Metallurgical Test Work, October 2014” (KCA,2014) and “Camino Rojo Project Report on Metallurgical Test Work, August 2015” (KCA, 2015).

The 2014 KCA program was conducted on 34 cut and broken core intervals from eight drill holes that were utilized for direct and CIL bottle roll leach tests. The 2015 KCA test program was conducted on cut and broken HQ core material from 469 sample bags, each labelled with a lithology and client sample ID which were used to generate thirteen composite samples. Each composite was utilized for head analyses (including preg-rob test work), direct and carbon in leach (CIL) bottle roll leach tests, and column leach tests.

A summary of the material as received is presented in Table 13-23 for the 2014 program and Table 13-24 for the 2015 program.

Results from the 2014 test program are discussed in this section where applicable.

Table 13-23
Description of Received Material– KCA 2014

KCA Sample No.	Drill Hole I.D.	Interval, metres		% Ox	Received Weight, kilograms
		From	To		
62949	CR13-379DB	549.5	551	90	6.15
62950	CR13-380D	749.5	751	90	6.07
62951	CR13-380D	751	752.5	90	5.85
62952	CR13-390D	581	582.5	98	5.87
62953	CR13-390D	582.5	584	98	5.39
62954	CR13-390D	584	585.5	98	5.73
62955	CR13-390D	675.5	677	80	4.43
62956	CR13-390D	677	678.5	80	4.59
62957	CR13-390D	681.5	683	80	5.29
62958	CR13-390D	684.5	686	80	4.92
62959	CR13-390D	687.5	689	70	5.46
62960	CR13-390D	689	690.5	80	4.42
62961	CR13-400D	421.5	423	80	6.14
62962	CR13-400D	423	424.5	80	5.70
62963	CR13-400D	424.5	426	80	5.99
62964	CR13-410DB	19.5	21	100	4.71
62965	CR13-410DB	67.5	69	100	5.30
62966	CR13-410DB	175.5	177	80	8.59
62967	CR13-410DB	193.5	195	70	5.62
62968	CR13-410DB	195	196.5	70	5.46
62969	CR13-410DB	196.5	198	70	4.70
62970	CR13-418D	33.5	35	100	4.44
62971	CR13-418D	63.5	65	100	5.01
62972	CR13-418D	72.5	74	100	5.15
62973	CR13-418D	77	78.5	100	4.96
62974	CR13-418D	98	99.5	100	4.28
62975	CR13-418D	134	135.5	80	5.34
62976	CR13-419D	40.5	42	100	5.35
62977	CR13-419D	84	85.5	100	4.99
62978	CR13-419D	96	97.5	100	5.23
62979	CR13-466D	639.5	641	70	5.28
62980	CR13-466D	647	648.5	90	4.49
62981	CR13-466D	648.5	650	90	4.68
62982	CR13-466D	675.5	677	70	5.52

Table 13-24
Description of Received Material– KCA 2015

KCA Sample No.	Material I.D.	Total Weight, kg
71815 A	HF - Ox 11	208.12
71816 A	HFT - Hi 2	184.00
71817 A	IHT-Hi 4	163.60
71818 A	HFT - Hi 8	189.06
71819 A	HFT - Lo 1	196.00
71820 A	HFT - Lo 7	219.80
71821 A	IH - Ox 12	133.04
71822 A	IHT - Lo 3	155.90
71823 A	OX - Ox 10	163.40
71824 A	OX - Ox 9	126.24
71825 A	PC - Ox 13	150.84
71826 A	PCT - Hi 6	169.88
71827 A	PCT - Lo 5	160.36
Total -		2220.24

13.2.5.1 *Kappes, Cassidy & Associates (2015) – Head Analyses*

Head analyses for gold and silver were completed by standard fire assay and wet chemistry methods for each composite and are presented in Table 13-25. Each composite was assayed quantitatively for carbon and sulphur and mercury and copper and are presented in Table 13-26 and Table 13-27. Semi-quantitative analyses for additional elements for whole rock constituents were also completed.

The head analyses show gold grades ranging between 0.29 and 1.65 g/t and silver grades ranging between 9.3 and 54.5 g/t. Organic carbon is present at relatively low percentages. Mercury and copper quantities were low and would not be expected to be problematic for cyanide leaching.

From the multi element analyses, arsenic (As), lead (Pb) and zinc (Zn) were elevated as is typically seen in association with high silver ores. Barium was elevated but does not generally present a problem in leaching.

Table 13-25
Head Analyses, Gold & Silver– KCA 2015

KCA Sample No.	Description	Average Assay, g/t Au	Average Assay, g/t Ag
71815 B	HF - Ox 11	1.128	17.95
71816 B	HFT - Hi 2	1.378	27.70
71817 B	IHT - Hi 4	0.890	26.19
71818 B	HFT - Hi 8	1.649	12.41
71819 B	HFT - Lo 1	0.979	13.90
71820 B	HFT - Lo 7	1.029	9.29
71821 B	IH - Ox 12	0.559	23.21
71822 B	IHT - Lo 3	0.847	28.06
71823 B	OX - Ox 9	0.291	11.61
71824 B	OX - Ox 10	0.785	13.30
71825 B	PC - Ox 13	0.618	14.81
71826 B	PCT - Hi 6	1.165	12.89
71827 B	PCT - Lo 5	0.991	54.51

Note - The detection limit for silver with FAAS finish is 0.21 g/t Ag.

Note - For the purpose of calculation a value of 1/2 the detection limit is utilized for assays less than the detection limit.

Table 13-26
Head Analyses Carbon & Sulphur– KCA 2015

KCA Sample No.	Description	Total Carbon, %	Organic Carbon, %	Inorganic Carbon, %	Total Sulphur, %	Sulphide Sulphur, %	Sulphate Sulphur, %
71815 B	HF - Ox 11	0.67	0.13	0.54	0.32	0.01	0.31
71816 B	HFT - Hi 2	0.27	0.10	0.17	0.82	0.46	0.35
71817 B	IHT - Hi 4	0.81	0.13	0.68	0.55	0.20	0.34
71818 B	HFT - Hi 8	1.17	0.19	0.97	1.80	1.29	0.52
71819 B	HFT - Lo 1	0.62	0.18	0.43	1.66	1.19	0.47
71820 B	HFT - Lo 7	1.39	0.20	1.19	1.71	1.21	0.50
71821 B	IH - Ox 12	0.43	0.11	0.32	0.40	0.11	0.29
71822 B	IHT - Lo 3	1.31	0.25	1.06	0.93	0.52	0.42
71823 B	OX - Ox 9	0.28	0.05	0.23	0.25	<0.01	0.25
71824 B	OX - Ox 10	0.76	0.08	0.69	0.17	<0.01	0.17
71825 B	PC - Ox 13	1.54	0.16	1.38	0.34	<0.01	0.34
71826 B	PCT - Hi 6	1.69	0.18	1.51	0.10	<0.01	0.10
71827 B	PCT - Lo 5	1.82	0.37	1.45	0.84	0.46	0.38

Table 13-27
Head Analyses Mercury & Copper– KCA 2015

KCA Sample No.	Description	Total Mercury, mg/kg	Total Copper, mg/kg	Cyanide ¹ Soluble Copper, mg/kg	Cyanide Soluble Copper, %
71815 B	HF - Ox 11	<0.02	118	30.4	26%
71816 B	HFT - Hi 2	<0.02	125	58.1	46%
71817 B	IHT - Hi 4	<0.02	80.2	15.3	19%
71818 B	HFT - Hi 8	<0.02	183	87.2	48%
71819 B	HFT - Lo 1	<0.02	168	55.8	33%
71820 B	HFT - Lo 7	<0.02	145	80.1	55%
71821 B	IH - Ox 12	<0.02	91.1	17.8	19%
71822 B	IHT - Lo 3	<0.02	102	50.0	49%
71823 B	OX - Ox 9	<0.02	74.2	3.51	5%
71824 B	OX - Ox 10	<0.02	94.2	3.01	3%
71825 B	PC - Ox 13	<0.02	71.4	9.30	13%
71826 B	PCT - Hi 6	<0.02	57.5	6.67	12%
71827 B	PCT - Lo 5	<0.02	66.1	33.5	51%

Note (1): Average assay from cyanide shake tests.

In addition to the head analyses, direct cyanide shake tests as well as cyanide shake tests with an added gold spike were conducted on each sample to evaluate the material for preg-robbing tendencies.

For the preg-rob cyanide shake tests, preg-robbing tendencies are determined by comparing the spiked shake test extraction and the original shake test extraction to determine a % preg-rob. Typically, % preg-robbing greater than 10% indicates preg-robbing tendencies. The cyanide shake test results suggest little or no preg-robbing tendencies with the oxide material and high preg-robbing tendencies with the transition samples, especially with the Trans-Lo material.

13.2.5.2 *Kappes, Cassiday & Associates (2014 & 2015) – Bottle Roll Leach Tests*

Direct and CIL (Carbon-In-Leach) bottle roll leach tests were conducted as part of the 2014 and 2015 test campaigns on portions of each sample or composite sample at 80% passing 0.125mm. Results from the bottle roll leach tests for the 2014 and 2015 programs are presented in Figure 13.2 and Figure 13.3 for gold, respectively. The direct-CIL bottle roll recovery difference vs. organic carbon percent for the 2015 program is presented in Figure 13.4.

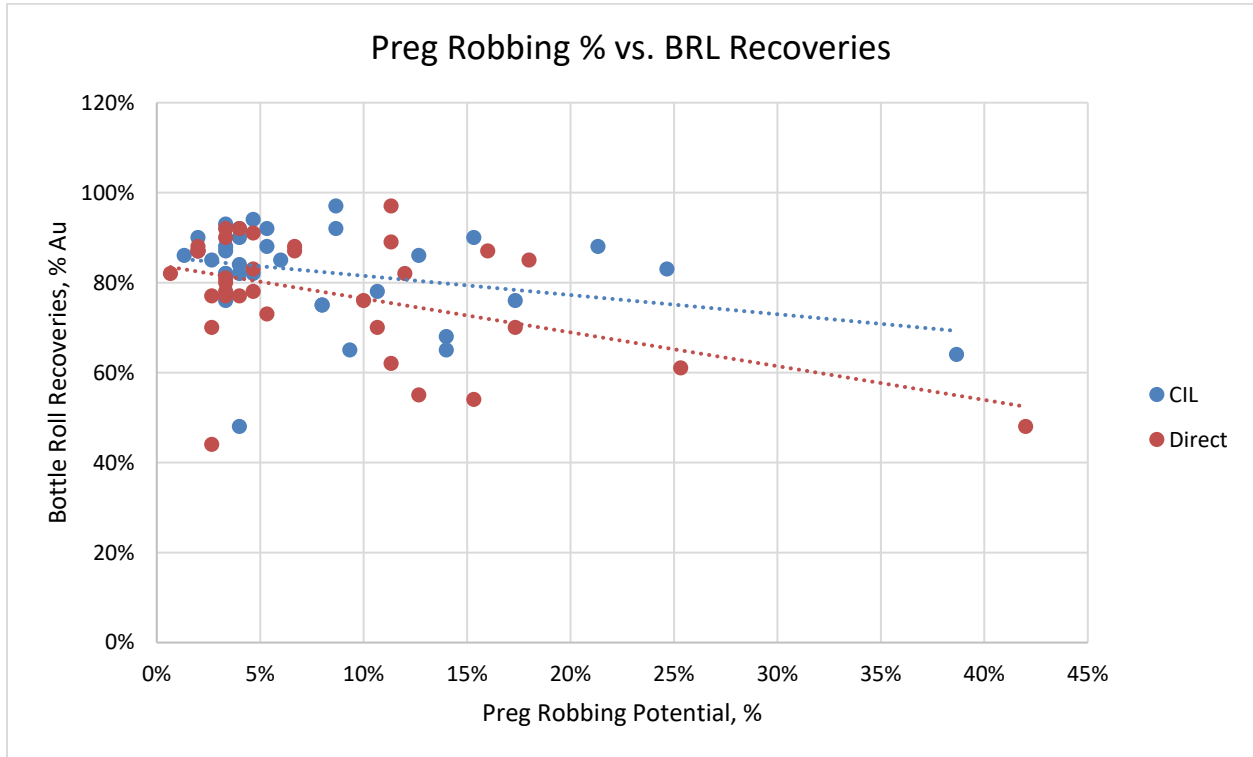

Figure 13.2 Preg-Robbing Percentage vs. CIL & Direct Bottle Roll Leach Test Recoveries – KCA 2014

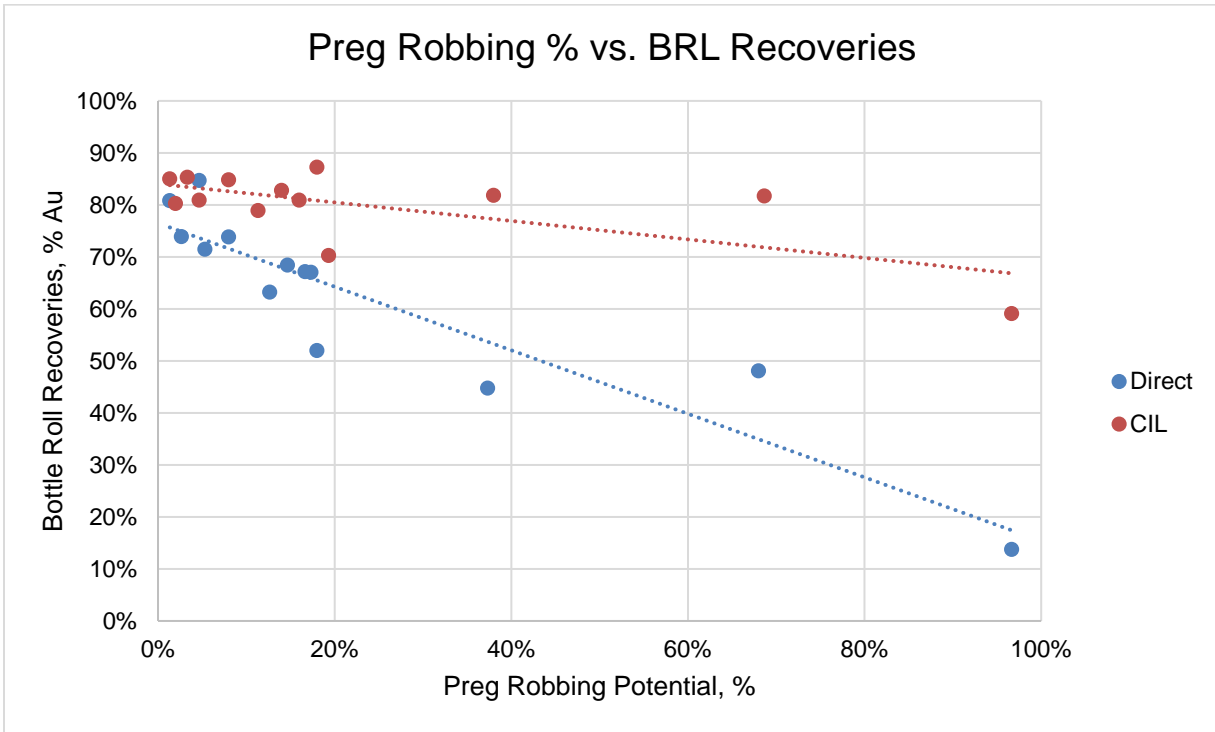

Figure 13.3 Preg-Robbing Percentage vs. CIL & Direct Bottle Roll Leach Test Recoveries – KCA 2015

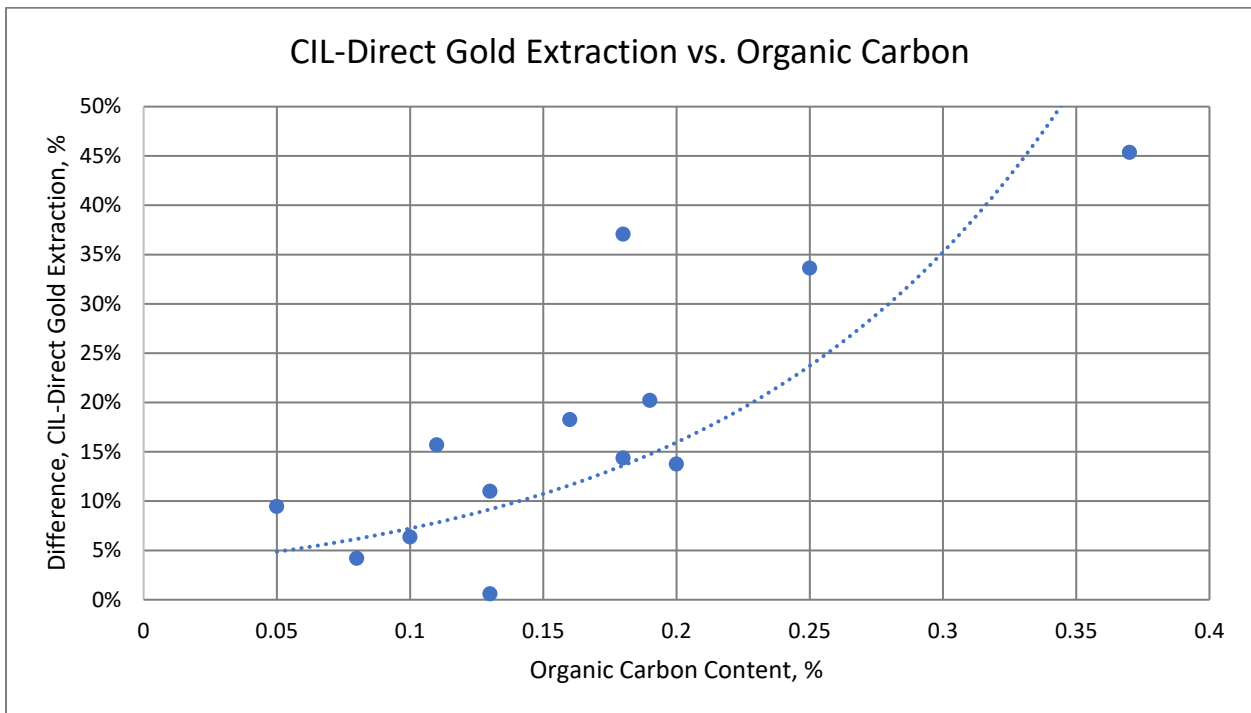

Figure 13.4 CIL-Direct Bottle Roll Au Extraction Difference vs. Organic Carbon Content – KCA 2015

Calculated leach preg robbing values based on the difference between CIL and direct bottle roll test recoveries ranged from 0% to 34% with higher preg-robbing tendencies associated with the transition composites. Based on KCA's experience, a difference greater than 3% indicates the material could be preg-robbing.

Preg-robbing test work performed on the head material did not prove to be an indication of preg-robbing during leaching. Samples that exhibited preg-robbing characteristics during the preg-robbing test work did not necessarily show the same characteristics during direct and CIL bottle roll leach tests. Additionally, no one individual drillhole exhibited any more tendency toward preg-robbing than another. No strong correlations were observed between sulphide sulphur content and preg-rob values, or between organic carbon content and preg-rob values. The bottle roll tests also did not show a strong correlation between percent gold recovery and sulphide content.

13.2.5.3 *Kappes, Cassidy & Associates (2015) – Column Leach Test Work*

Column leach tests were conducted on each sample at crush sizes of 100% passing 25mm and 100% passing 12.5mm and were leached for 90 days. Results from the column leach tests for gold and silver are presented in Table 13-28.

Column test results on material crushed to 100% passing 25mm and 12.5mm show only minor recovery improvements with finer crushing with the exception of oxide and transitional material logged as hornfels and incipient hornfels, which benefitted from a 3% to 5% recovery increase for oxide material and 4% to 10% increase for transition material with finer crush size.

Table 13-28
KCA 2015 Column Leach Test Results by Lithology

Description	Crush Size, mm	Calculated Head, g/t Au	Extracted, % Au	Calculated Head, g/t Ag	Extracted, % Ag	Calculated Tail P ₈₀ Size, mm	Consumption NaCN, kg/t	Addition Hydrated Lime, kg/t
HF - Ox 11	25	1.060	78%	14.09	21%	16.52	1.39	1.00
HF - Ox 11	12.5	1.033	81%	13.28	32%	9.27	1.42	1.01
HFT - Hi 2	25	0.834	72%	23.67	31%	17.71	1.49	1.00
HFT - Hi 2	12.5	0.855	75%	22.74	46%	9.93	1.37	1.00
IHT - Hi 4	25	0.812	68%	17.90	25%	18.29	1.35	1.00
IHT - Hi 4	12.5	0.858	73%	17.33	38%	9.92	1.37	1.00
HFT - Hi 8	25	1.095	72%	10.51	44%	18.32	1.44	1.01
HFT - Hi 8	12.5	0.973	74%	10.50	54%	10.16	1.52	1.02
HFT - Lo 1	25	0.817	61%	10.91	35%	18.06	1.51	0.95
HFT - Lo 1	12.5	0.788	63%	10.82	51%	9.51	1.33	0.95
HFT - Lo 7	25	0.880	63%	5.32	41%	17.58	1.30	0.99
HFT - Lo 7	12.5	0.912	70%	4.97	62%	9.84	1.79	0.99
IH - Ox 12	25	0.610	59%	16.22	22%	18.75	1.22	1.01
IH - Ox 12	12.5	0.589	63%	15.98	40%	9.90	1.59	1.01
IHT - Lo 3	25	0.911	57%	23.25	33%	18.26	1.47	1.01
IHT - Lo 3	12.5	0.932	58%	22.04	49%	9.74	1.45	1.01
OX - Ox 9	25	0.269	73%	9.79	12%	18.66	1.41	1.01
OX - Ox 9	12.5	0.281	74%	9.58	22%	9.77	1.54	1.01
OX - Ox 10	25	0.729	78%	11.55	2%	17.66	0.89	1.01
OX - Ox 10	12.5	0.765	79%	10.95	4%	10.01	0.76	1.01
PC - Ox 13	25	0.557	60%	14.35	30%	18.10	1.24	0.93
PC - Ox 13	12.5	0.554	55%	14.56	36%	13.66 ¹	1.25	0.93
PCT - Hi 6	25	1.069	72%	11.87	37%	17.64	1.52	1.01
PCT - Hi 6	12.5	1.087	69%	11.33	45%	9.51	1.24	1.04
PCT - Lo 5	25	0.922	37%	43.26	50%	18.19	1.56	1.01
PCT - Lo 5	12.5	0.989	26%	49.68	56%	9.06	1.54	1.01

13.3 Orla (2019 & 2020)

Orla commissioned KCA in 2018 to perform confirmatory test work on the Camino Rojo ore. The Camino Rojo ore body contains three basic material types which include Oxide, Sulphide, and Transition material. These material types have been further defined into distinct groups beyond the basic classifications. Oxide material has been classified relative to the material's K alteration values from ICP testing and include the Kp (pervasive) and Ki (incipient) oxides. Transition material has been classified based on oxidation level via qualitative indicators which include Transition-Hi (60 to 90% oxidized), Transition-Lo (30 to 60% oxidized), and Transition-S (Sulphide, <30% oxidized). Transition-S material is not included in the Mineral Resource for the Camino Rojo Project. The test work included column leach and bottle roll leach tests on each of

the primary ore types (Kp Oxide, Ki Oxide, Transition Hi and Transition Lo) as well as physical characterization and cyanide neutralization test work.

13.3.1 Kappes, Cassidy & Associates (2019)

Results for the 2019 KCA test program summarized herein are extracted from the KCA laboratory report titled “Camino Rojo Project Kp, Ki, TrSx(H), TrHi and TrLo Composites Report on Metallurgical Test Work, June 2019” (KCA, 2019).

The 2019 KCA test program was conducted on PQ core material which was used to generate seven composites based on material types. Figure 13.5 presents the location of the drill holes for the samples and a description of material received is presented in Table 13-29. Details on the composite generation are presented in Table 13-30.

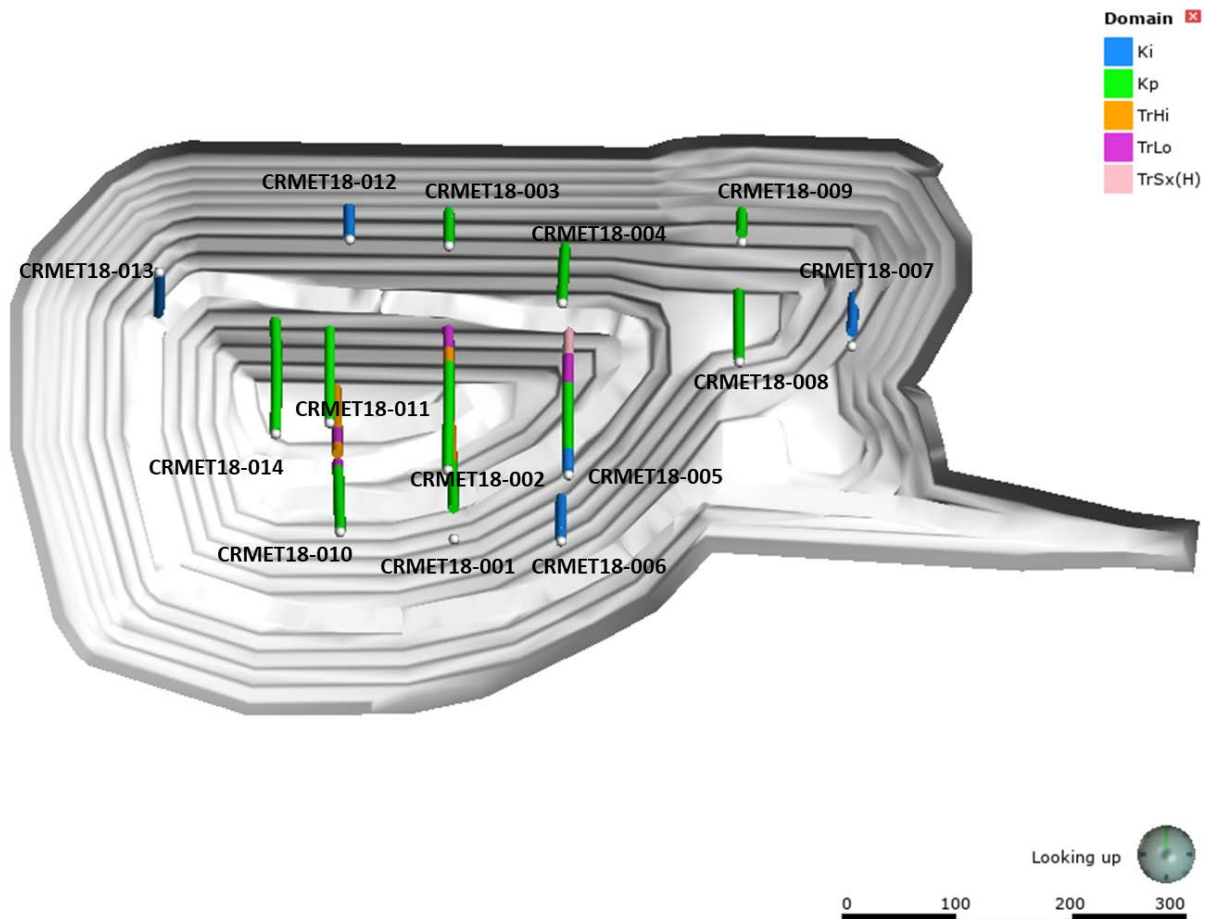

Figure 13.5 Sample Drillhole Locations for KCA 2019 Test Program

Table 13-29
Description of Received Material – KCA 2019

KCA Sample No.	Client I.D.	Received Weight, kg
82401 A	CRMET18-001, 54 to 135 metres	1,030.0
82402 A	CRMET18-002, 2 to 143 metres	1,472.5
82403 A	CRMET18-003, 2 to 106 metres	1,037.5
82417 A	CRMET18-010, 3 to 84 metres	909.5
82418 A	CRMET18-010, 84 to 108 metres	258.5
82419 A	CRMET18-011, 2 to 75 metres	745.5
82420 A	CRMET18-011, 75 to 126 metres	511.0
82457 A	CRMET18-014, 2 to 160 metres	1,550.5
82421 A	CRMET18-004, 2 to 129.5 metres	1,278.1
82422 A	CRMET18-005, 31 to 122 metres	954.0
82423 A	CRMET18-008, 4 to 126 metres	1,386.5
82424 A	CRMET18-009, 14 to 134 metres	1,449.0
82425 A	CRMET18-005, 4 to 31 metres	293.1
82426 A	CRMET18-006, 2 to 75 metres	886.3
82427 A	CRMET18-007, 26 to 100 metres	897.2
82428 A	CRMET18-012, 3 to 75.5 metres	863.5
82429 A	CRMET18-013, 2 to 70 metres	807.5
82430 A	CRMET18-001, 135 to 212 metres	973.0
82431 A	CRMET18-002, 143 to 162 metres	264.3
82432 A	CRMET18-003, 106 to 117 metres	148.9
82433 A	CRMET18-008, 126 to 142 metres	214.6
82434 A	CRMET18-009, 165 to 170 metres	66.0
82435 A	CRMET18-010, 135 to 149 metres	1,088.4
82436 A	CRMET18-010, 175 to 250 metres	
82437 A	CRMET18-001, 212 to 245 metres	459.4
82438 A	CRMET18-002, 162 to 255 metres	1,185.4
82439 A	CRMET18-003, 117 to 127 metres	126.8
82440 A	CRMET18-003, 139 to 160 metres	292.3
82441 A	CRMET18-005, 122 to 162 metres	530.0
82442 A	CRMET18-005, 196 to 227 metres	409.0
82443 A	CRMET18-008, 142 to 180 metres	488.0
82444 A	CRMET18-009, 148 to 165 metres	219.0
82445 A	CRMET18-010, 108 to 120 metres	179.0
82446 A	CRMET18-010, 149 to 175 metres	380.0
82447 A	CRMET18-001, 245 to 279 metres	493.5
82448 A	CRMET18-005, 162 to 196 metres	445.0
82449 A	CRMET18-005, 227 to 237.5 metres	138.4
82550 A	CRMET18-009, 134 to 148 metres	184.5

**Table 13-30
Composite Generation Information – KCA 2019**

KCA Composite No.	KCA Sample No.	Description	Client I.D.	Weight to Composite, kg
82404 A	82401 A	Kp 4400 Composite	CRMET18-001, 54 to 135 metres	300.0
	82402 A		CRMET18-002, 2 to 143 metres	300.0
	82403 A		CRMET18-003, 2 to 106 metres	600.0
Total Weight, kg				1,200.0
82451 A	82417 A	Kp 4300 Composite	CRMET18-010, 3 to 84 metres	139.3
	82418 A		CRMET18-010, 84 to 108 metres	158.4
	82419 A		CRMET18-011, 2 to 75 metres	114.2
	82420 A		CRMET18-011, 75 to 126 metres	313.1
	82457 A		CRMET18-014, 2 to 160 metres	475.0
Total Weight, kg				1,200.0
82452 A	82421 A	Kp 4500/4650 Composite	CRMET18-004, 2 to 129.5 metres	689.2
	82422 A		CRMET18-005, 31 to 122 metres	128.6
	82423 A		CRMET18-008, 4 to 126 metres	186.9
	82424 A		CRMET18-009, 14 to 134 metres	195.3
Total Weight, kg				1,200.0
82453 A	82425 A	Ki Composite	CRMET18-005, 4 to 31 metres	55.7
	82426 A		CRMET18-006, 2 to 75 metres	168.4
	82427 A		CRMET18-007, 26 to 100 metres	341.0
	82428 A		CRMET18-012, 3 to 75.5 metres	328.1
	82429 A		CRMET18-013, 2 to 70 metres	306.8
Total Weight, kg				1,200.0
82454 A	82430 A	TrHi Composite	CRMET18-001, 135 to 212 metres	423.8
	82431 A		CRMET18-002, 143 to 162 metres	115.1
	82432 A		CRMET18-003, 106 to 117 metres	64.9
	82433 A		CRMET18-008, 126 to 142 metres	93.5
	82434 A		CRMET18-009, 165 to 170 metres	28.8
	82435 A		CRMET18-010, 135 to 149 metres	474.0
	82436 A		CRMET18-010, 175 to 250 metres	
Total Weight, kg				1,200.0
82455 A	82437 A	TrLo Composite	CRMET18-001, 212 to 245 metres	129.1
	82438 A		CRMET18-002, 162 to 255 metres	333.2
	82439 A		CRMET18-003, 117 to 127 metres	35.7
	82440 A		CRMET18-003, 139 to 160 metres	82.2
	82441 A		CRMET18-005, 122 to 162 metres	149.0
	82442 A		CRMET18-005, 196 to 227 metres	115.0
	82443 A		CRMET18-008, 142 to 180 metres	137.2
	82444 A		CRMET18-009, 148 to 165 metres	61.6
	82445 A		CRMET18-010, 108 to 120 metres	50.3
	82446 A		CRMET18-010, 149 to 175 metres	106.8
Total Weight, kg				1,200.0
82556 A	82447 A	TrSx(H) Composite	CRMET18-001, 245 to 279 metres	195.6
	82448 A		CRMET18-005, 162 to 196 metres	176.4
	82449 A		CRMET18-005, 227 to 237.5 metres	54.9
	82550 A		CRMET18-009, 134 to 148 metres	73.1
Total Weight, kg				500.0

13.3.1.1 *Kappes, Cassiday & Associates (2019) – Head Analyses & Physical Characterization*

Material from each composite was assayed for gold and silver content by standard fire assay and wet chemistry methods and results are presented in Table 13-31 along with the expected / target grade based on previous drill results. Gold grades ranged between 0.26 and 1.5 g/t and were generally slightly lower than the expected grades. Silver grades ranged between 6.8 and 27.9 g/t and were typically close to the expected grades with the exception of the Trans-Lo and Trans-Sx composites which were significantly higher than expected.

Composite samples were also assayed by quantitative methods for carbon and sulphur, copper and mercury and zinc and lead which are presented in Table 13-32, Table 13-33 and Table 13-34, respectively. Based on these results, the material does show some organic carbon with higher percentages associated with the transition and sulphide composites. Mercury is present in most of the samples and will require treatment for recovery during operations. Copper concentrations are low and are not expected to present any issues with cyanide leaching. Semi-quantitative multi-element analyses for whole rock constituents were also performed and are presented in Table 13-35 and Table 13-36.

Table 13-31
Head Analyses Gold & Silver – KCA 2019

KCA Sample No.	Description	Client Expected Grade, g/t Au	Average Assay, g/t Au	Client Expected Grade, g/t Ag	Average Assay, g/t Ag
82404 C	Kp 4400 Composite	0.77	0.550	14.4	12.51
82451 C	Kp 4300 Composite	1.07	0.820	12.4	11.69
82452 C	Kp 4500/4650 Composite	0.63	0.537	14.6	16.54
82453 C	Ki Composite	0.35	0.264	7.3	6.79
82454 C	TrHi Composite	0.97	0.983	25.3	30.39
82455 C	TrLo Composite	0.85	0.749	16.2	37.90
82456 C	TrSx(H) Composite	0.98	1.524	15.2	28.90

Note - The detection limit for silver with FAAS finish is 0.21 g/t.

Note - For the purpose of calculation a value of 1/2 the detection limit is utilized for assays less than the detection limit.

Table 13-32
Head Analyses Carbon & Sulphur – KCA 2019

KCA Sample No.	Description	Total Carbon, %	Organic Carbon, %	Inorganic Carbon, %	Total Sulphur, %	Sulphide Sulphur, %	Sulphate Sulphur, %
82404 C	Kp 4400 Composite	0.85	0.03	0.81	0.07	0.02	0.05
82451 C	Kp 4300 Composite	0.44	0.06	0.37	0.27	0.01	0.26
82452 C	Kp 4500/4650 Composite	0.40	0.04	0.36	0.13	<0.01	0.13
82453 C	Ki Composite	1.23	0.03	1.20	0.04	<0.01	0.03
82454 C	TrHi Composite	0.33	0.13	0.20	0.67	0.35	0.33
82455 C	TrLo Composite	0.54	0.18	0.36	1.82	1.34	0.48
82456 C	TrSx(H) Composite	0.77	0.22	0.55	5.50	4.60	0.90

Table 13-33
Head Analyses Mercury & Copper – KCA 2019

KCA Sample No.	Description	Total Mercury, mg/kg	Total Copper, mg/kg	Cyanide Soluble Copper, mg/kg	Cyanide Soluble Copper, %
82404 C	Kp 4400 Composite	0.02	97	6.91	7%
82451 C	Kp 4300 Composite	<0.02	114	6.41	6%
82452 C	Kp 4500/4650 Composite	0.03	88	5.92	7%
82453 C	Ki Composite	0.08	45	1.99	4%
82454 C	TrHi Composite	0.04	122	67.65	55%
82455 C	TrLo Composite	0.05	83	64.55	78%
82456 C	TrSx(H) Composite	0.05	85	57.30	67%

Note - The cyanide soluble copper is an average of two cyanide shake analyses.

Table 13-34
Head Analyses Lead & Zinc – KCA 2019

KCA Sample No.	Description	Lead, mg/kg	Zinc, mg/kg
82404 C	Kp 4400 Composite	2010	2470
82451 C	Kp 4300 Composite	4210	3140
82452 C	Kp 4500/4650 Composite	3630	4720
82453 C	Ki Composite	1460	1980
82454 C	TrHi Composite	2480	6250
82455 C	TrLo Composite	2100	5950
82456 C	TrSx(H) Composite	2060	8030

Table 13-35
Head Analyses Multi-Element Analysis – KCA 2019

Constituent	Unit	Kp 4400 Composite 82404 C	Kp 4300 Composite 82451 C	Kp 4500/4650 Composite 82452 C	Ki Composite 82453 C	TrHi Composite 82454 C	TrLo Composite 82455 C	TrSx(H) Composite 82456 C
Al	%	7.31	7.16	7.05	6.40	7.09	6.69	6.31
As	mg/kg	660	811	547	523	630	503	585
Ba	mg/kg	7.81	1040	1060	497	1220	1190	1130
Bi	mg/kg	27	11	3	3	8	5	12
C _(total)	%	0.85	0.44	0.40	1.23	0.33	0.54	0.77
C _(organic)	%	0.03	0.06	0.04	0.03	0.13	0.18	0.22
C _(inorganic)	%	0.81	0.37	0.36	1.20	0.20	0.36	0.55
Ca	%	2.87	1.44	1.37	3.97	1.14	1.59	1.91
Cd	mg/kg	35	36	37	37	75	91	96
Co	mg/kg	18	16	14	14	11	11	17
Cr	mg/kg	68	76	77	64	79	75	80
Cu _(total)	mg/kg	97	114	88	45	122	83	85
Cu _(cyanide soluble)	mg/kg	6.91	6.41	5.92	1.99	67.65	64.55	57.30
Fe	%	4.91	5.69	4.96	3.54	5.82	4.70	6.09
Hg	mg/kg	0.02	<0.02	0.03	0.08	0.04	0.05	0.05
K	%	4.61	6.19	5.88	2.99	7.20	6.75	7.14
Mg	%	0.83	0.65	0.63	1.15	0.41	0.37	0.59
Mn	mg/kg	1130	775	958	836	223	362	511
Mo	mg/kg	2	4	<1	<1	<1	<1	<1
Na	%	0.33	0.44	0.21	0.64	0.20	0.19	0.16
Ni	mg/kg	53	47	53	53	40	37	46
Pb	mg/kg	2010	4210	3630	1460	2480	2100	2060
S _(total)	%	0.07	0.27	0.13	0.04	0.67	1.82	5.50
S _(sulphide)	%	0.02	0.01	<0.01	<0.01	0.35	1.34	4.60
S _(sulphate)	%	0.05	0.26	0.13	0.03	0.33	0.48	0.90
Sb	mg/kg	30	37	24	13	22	16	11
Se	mg/kg	12	13	13	11	48	39	29
Sr	mg/kg	184	271	208	151	190	212	197
Te	mg/kg	14	18	11	8	17	15	21
Ti	%	0.32	0.21	0.20	0.29	0.21	0.21	0.19
V	mg/kg	177	173	182	175	150	133	130
W	mg/kg	33	39	54	23	69	68	100
Zn	mg/kg	2470	3140	4720	1980	6250	5950	8030

Table 13-36
Head Analyses Whole Rock Analysis – KCA 2019

Constituent	Unit	Kp 4400 Composite 82404 C		Kp 4300 Composite 82451 C		Kp 4500/4650 Composite 82452 C		Ki Composite 82453 C		TrHi Composite 82454 C	
SiO ₂	%	59.5		58.4		61.68		58.35		60.0	
Si	%		27.82		27.30		28.84		27.28		28.05
Al ₂ O ₃	%	14.3		14.7		13.82		13.83		14.4	
Al	%		7.57		7.78		7.32		7.32		7.62
Fe ₂ O ₃	%	6.92		7.65		7.06		5.17		9.20	
Fe	%		4.84		5.35		4.94		3.62		6.43
CaO	%	3.98		1.95		2.07		6.03		1.73	
Ca	%		2.84		1.39		1.48		4.31		1.24
MgO	%	1.48		1.12		1.04		2.09		0.91	
Mg	%		0.89		0.68		0.63		1.26		0.55
Na ₂ O	%	0.39		0.34		0.32		0.97		0.30	
Na	%		0.29		0.25		0.24		0.72		0.22
K ₂ O	%	5.72		8.08		7.37		4.02		7.85	
K	%		4.75		6.71		6.12		3.34		6.51
TiO ₂	%	0.71		0.76		0.74		0.65		0.73	
Ti	%		0.43		0.46		0.44		0.39		0.44
MnO	%	0.15		0.11		0.12		0.11		0.03	
Mn	%		0.12		0.09		0.09		0.09		0.02
SrO	%	0.01		0.02		0.01		0.01		0.01	
Sr	%		0.01		0.02		0.01		0.01		0.01
BaO	%	0.08		0.12		0.11		0.05		0.14	
Ba	%		0.07		0.11		0.10		0.04		0.13
Cr ₂ O ₃	%	0.01		0.01		0.01		0.01		0.01	
Cr	%		0.01		0.01		0.01		0.01		0.01
P ₂ O ₅	%	0.17		0.21		0.14		0.16		0.19	
P	%		0.07		0.09		0.06		0.07		0.08
LOI _{1050°C}	%	6.13		5.04		4.69		8.14		4.55	
SUM	%	99.55		98.51		99.18		99.59		100.05	

Note: The SUM is the total of the oxide constituents and the loss on ignition.

Note - For the purpose of calculation a value of 1/2 the detection limit is utilized for assays less than the detection limit.

Cyanide shakes tests were conducted to evaluate preg-robbing tendencies in the different material composites. Direct and spiked cyanide shake tests were performed with preg-robbing tendencies being determined by comparing the spiked shake test extraction and the direct shake test extractions to determine a % preg-rob.

Typically, % preg-robbing greater than 10% indicates preg-robbing tendencies. The results indicate no preg-robbing tendencies for the oxide composites with observed moderate preg-robbing tendencies with all of the transition and sulphide samples. The preg-robbing results show a general trend of increased preg robbing tendencies with increased organic carbon content.

A portion of each of the composites were submitted to Hazen Research in Golden, Colorado for comminution testing. Comminution test results are presented in Table 13-37.

Table 13-37
Physical Characterization Test Work Summary – KCA 2019

KCA Sample No.	Client I.D.	Crusher Work Index		Abrasion Index
		kWh/short ton	kWh/metric tonne	A _i , g
82405 A	Kp 4400	10.8	11.9	0.0286
82458 A	Ki	10.4	11.5	0.0262
82459 A	TriHi	10.5	11.6	0.1764
82460 A	TriLo	10.1	11.2	0.2286
82461 A	TrSx(H)	10.6	11.7	0.2164

The results indicate average hardness with low to moderate abrasion.

13.3.1.2 *Kappes, Cassidy & Associates (2019) – Bottle Roll Leach Tests*

Bottle roll leach testing was conducted on material from each composite (Kp 4400 Composite, Kp 4300 Composite, Kp 4500/4650 Composite, Ki Composite, TrHi Composite, TrLo Composite and TrSx(H) Composite). A 1,000-gram portion of head material was pulverized to a target of 100% passing 0.15mm. Results from the bottle roll tests are presented in Table 13-38 and Table 13-39 for gold and silver, respectively.

Table 13-38
Bottle Roll Leach Test Summary, Gold – KCA 2019

KCA Sample No.	Description	Target P ₈₀ Size, mm	Calculated Head, g/t Au	Extracted, g/t Au	Avg. Tail, g/t Au	Au Extracted, %	Leach Time, hours	Consumption NaCN, kg/t	Addition Ca(OH) ₂ , kg/t
82404 C	Kp 4400 Composite	0.075	0.569	0.494	0.075	87%	96	0.09	2.00
82451 C	Kp 4300 Composite	0.075	1.020	0.933	0.087	92%	96	0.33	1.75
82452 C	Kp 4500/4650 Composite	0.075	0.494	0.409	0.086	83%	96	0.33	1.75
82453 C	Ki Composite	0.075	0.170	0.124	0.046	73%	96	0.19	1.75
82454 C	TrHi Composite	0.075	0.976	0.751	0.225	77%	96	0.81	1.75
82454 C	TrHi Composite	0.075	0.878	0.647	0.231	74%	96	0.64	1.25
	Average:		0.927	0.699	0.228	76%			
82455 C	TrLo Composite	0.075	0.683	0.161	0.523	23%	96	0.75	1.50
82456 C	TrSx(H) Composite	0.075	2.337	1.138	1.198	49%	96	1.34	1.50
82456 C	TrSx(H) Composite	0.075	3.742	2.216	1.526	59%	96	1.99	1.00
	Average:		3.039	1.677	1.362	54%			

Table 13-39
Bottle Roll Leach Test Summary, Silver – KCA 2019

KCA Sample No.	Description	Target P ₈₀ Size, mm	Calculated Head, g/t Ag	Extracted, g/t Ag	Avg. Tails, g/t Ag	Ag Extracted, %	Leach Time, hours	Consumption NaCN, kg/t	Addition Ca(OH) ₂ , kg/t
82404 C	Kp 4400 Composite	0.075	12.80	6.49	6.31	51%	96	0.09	2.00
82451 C	Kp 4300 Composite	0.075	12.21	6.05	6.15	50%	96	0.33	1.75
82452 C	Kp 4500/4650 Composite	0.075	17.30	8.09	9.21	47%	96	0.33	1.75
82453 C	Ki Composite	0.075	6.67	1.57	5.11	23%	96	0.19	1.75
82454 C	TrHi Composite	0.075	29.53	22.02	7.51	75%	96	0.81	1.75
82454 C	TrHi Composite	0.075	31.50	23.79	7.71	76%	96	0.64	1.25
	Average:		30.52	22.91	7.61	75%			
82455 C	TrLo Composite	0.075	36.34	15.44	20.90	42%	96	0.75	1.50
82456 C	TrSx(H) Composite	0.075	29.74	20.78	8.96	70%	96	1.34	1.50
82456 C	TrSx(H) Composite	0.075	36.22	32.31	3.91	89%	96	1.99	1.00
	Average:		32.98	26.55	6.43	80%			

For the pulverized composite material, gold extractions ranged from 23% to 92% based on calculated heads and silver extractions ranged between 23% and 89%. The results indicate that the oxide composites are amenable to cyanide leaching. Transition material recoveries for gold were lower compared to the oxide.

13.3.1.3 *Kappes, Cassidy & Associates (2019) – Agglomeration Test Work*

Preliminary agglomeration test work and compacted permeability test work were conducted on portions of each composite. Agglomeration tests were conducted utilizing portions of the material at a crushed size of 100% passing 12.5 millimetres and agglomerated with 0, 2, 4 and 8 kilograms of cement per tonne of material. Based on KCA's criteria, all samples passed up to an effective heap height of 90m and cement agglomeration would not be required for material crushed to 12.5mm or coarser.

13.3.1.4 *Kappes, Cassidy & Associates (2019) – Column Leach Test Work*

Column leach tests were conducted utilizing material crushed to 100% passing 150, 50 and 12.5mm for each composite (Kp 4400 Composite, Kp 4300 Composite, Kp 4500/4650 Composite, Ki Composite, TrHi Composite and TrLo Composite) and 50mm for the TrSx(H) Composite. During testing, the material was leached for 82, 85, 95 and 114 days with a sodium cyanide solution.

The column leach test results are presented in Table 13-40 and Table 13-41 for gold and silver, respectively.

Results indicate gold recoveries for the Kp oxide material ranging between 44% and 82% with results for the Kp 4500/4650 being generally lower than the other Kp oxide results and silver recoveries being between 3 to 24%. Ki gold recoveries were lower and ranged from 47 to 64% with silver extractions between 1 to 5 %. Metal extractions for TrHi ranged between 44 to 64% gold and 5 to 49 % for silver. TrLo metal recoveries ranged between 30 to 41% for gold and 10 to 58 % for silver. Gold recoveries for the TrSx(H) Composite were low at 33%, indicating that the sulphide material is not amenable to direct leaching and supports the mine modelling treating all Tr(Sx) as waste.

In general, recoveries improved with finer crushing with silver recoveries being more sensitive to crush size than gold. Recovery improvements were more significant for 150mm to 50mm than 50mm to 12.5mm. Tests indicate there is not a strong correlation between head grade and metal recovery for gold; however, silver recoveries appear to improve with higher head grades.

After completion of leaching, columns were allowed to drain for 168 hours. After draining, select columns at the 50mm crush size were utilized for water rinsing or chemical neutralization using the INCO SO₂ method. Results are presented in Figure 13.6 for water rinsing and Figure 13.7 for chemical neutralization.

Table 13-40
Column Leach Tests Results Summary, Gold – KCA 2019

KCA Sample No.	Description	Crush Size, mm	Calculated Head, g Au/MT	Extracted, g Au/MT	Weighted Avg. Tail Screen, g Au/MT	Extracted, % Au	Days of Leach	Days of Wash/Detox	Consumption NaCN, kg/t	Addition Hydrated Lime, kg/t	Addition Cement, kg/t
82404 A	Kp 4400 Composite	150	0.538	0.357	0.181	66%	114	--	0.98	1.51	0.00
82404 B	Kp 4400 Composite	50	0.583	0.427	0.156	73%	114	31w	0.82	2.00	0.00
82404 C	Kp 4400 Composite	12.5	0.619	0.497	0.122	80%	114	--	0.99	2.37	0.00
Avg.			0.580								
Std. Dev.			0.041								
RSD, %			7%								
82451 A	Kp 4300 Composite	150	1.003	0.687	0.316	69%	82	--	0.38	1.80	0.00
82451 B	Kp 4300 Composite	50	0.877	0.711	0.166	81%	95	21d	1.09	1.76	0.00
82451 C	Kp 4300 Composite	12.5	0.849	0.694	0.155	82%	85	--	0.97	1.77	0.00
Avg.			0.910								
Std. Dev.			0.082								
RSD, %			9%								
82452 A	Kp 4500/4650 Composite	150	0.547	0.241	0.306	44%	82	--	0.39	1.68	0.00
82452 B	Kp 4500/4650 Composite	50	0.526	0.310	0.216	59%	95	--	0.79	1.76	0.00
82452 C	Kp 4500/4650 Composite	12.5	0.542	0.371	0.171	68%	85	--	0.97	1.76	0.00
Avg.			0.538								
Std. Dev.			0.011								
RSD, %			2%								
82453 A	Ki Composite	150	0.333	0.155	0.178	47%	82	--	0.50	1.73	0.00
82453 B	Ki Composite	50	0.306	0.189	0.117	62%	95	21w	0.77	1.77	0.00
82453 C	Ki Composite	12.5	0.279	0.178	0.101	64%	85	--	0.95	1.77	0.00
Avg.			0.306								
Std. Dev.			0.027								
RSD, %			9%								
82454 A	TrHi Composite	150	0.881	0.385	0.496	44%	82	--	0.32	1.72	0.00
82454 B	TrHi Composite	50	1.225	0.565	0.660	46%	95	39d	0.61	1.63	0.00
82454 C	TrHi Composite	12.5	1.042	0.662	0.380	64%	85	--	0.75	1.77	0.00
Avg.			1.049								
Std. Dev.			0.172								
RSD, %			16%								
82455 A	TrLo Composite	150	0.843	0.257	0.586	30%	82	--	0.39	1.72	0.00
82455 B	TrLo Composite	50	0.856	0.347	0.509	41%	95	25d	0.88	1.63	0.00
82455 C	TrLo Composite	12.5	0.749	0.304	0.445	41%	85	--	0.95	1.52	0.00
Avg.			0.816								
Std. Dev.			0.058								
RSD, %			7%								
82456 A	TrSx(H) Composite	50	1.277	0.423	0.854	33%	95	21w	0.48	1.78	0.00

Table 13-41
Column Leach Tests Results Summary, Silver – KCA 2019

KCA Sample No.	Description	Crush Size, mm	Calculated Head, g/t Ag	Extracted, g/t Ag	Weighted Avg. Tail Screen, g/t Ag	Extracted, % Ag	Days of Leach	Days of Wash/Detox	Consumption NaCN, kg/t	Addition Hydrated Lime, kg/t	Addition Cement, kg/t
82404 A	Kp 4400 Composite	150	9.44	0.47	8.97	5%	114	--	0.98	1.51	0.00
82404 B	Kp 4400 Composite	50	10.75	1.00	9.75	9%	114	31w	0.82	2.00	0.00
82404 C	Kp 4400 Composite	12.5	11.58	2.16	9.42	19%	114	--	0.99	2.37	0.00
Avg.			10.59								
Std. Dev.			1.08								
RSD, %			10%								
82451 A	Kp 4300 Composite	150	10.31	0.35	9.96	3%	82	--	0.38	1.80	0.00
82451 B	Kp 4300 Composite	50	11.62	0.67	10.95	6%	95	21d	1.09	1.76	0.00
82451 C	Kp 4300 Composite	12.5	9.32	1.24	8.08	13%	85	--	0.97	1.77	0.00
Avg.			10.42								
Std. Dev.			1.15								
RSD, %			11%								
82452 A	Kp 4500/4650 Composite	150	15.32	0.70	14.62	5%	82	--	0.39	1.68	0.00
82452 B	Kp 4500/4650 Composite	50	16.50	1.31	15.19	8%	95	--	0.79	1.76	0.00
82452 C	Kp 4500/4650 Composite	12.5	16.86	4.09	12.77	24%	85	--	0.97	1.76	0.00
Avg.			16.23								
Std. Dev.			0.81								
RSD, %			5%								
82453 A	Ki Composite	150	5.06	0.07	4.99	1%	82	--	0.50	1.73	0.00
82453 B	Ki Composite	50	7.17	0.28	6.89	4%	95	21w	0.77	1.77	0.00
82453 C	Ki Composite	12.5	6.52	0.33	6.19	5%	85	--	0.95	1.77	0.00
Avg.			6.25								
Std. Dev.			1.08								
RSD, %			17%								
82454 A	TrHi Composite	150	27.79	1.36	26.31	5%	82	--	0.32	1.72	0.00
82454 B	TrHi Composite	50	29.71	4.69	25.02	16%	95	39d	0.61	1.63	0.00
82454 C	TrHi Composite	12.5	23.36	11.35	12.01	49%	85	--	0.75	1.77	0.00
Avg.			26.95								
Std. Dev.			3.26								
RSD, %			12%								
82455 A	TrLo Composite	150	18.92	1.95	16.97	10%	82	--	0.39	1.72	0.00
82455 B	TrLo Composite	50	16.67	4.63	12.04	28%	95	25d	0.88	1.63	0.00
82455 C	TrLo Composite	12.5	16.12	9.38	6.74	58%	85	--	0.95	1.52	0.00
Avg.			17.24								
Std. Dev.			1.48								
RSD, %			9%								
82456 A	TrSx(H) Composite	50	20.67	6.43	14.24	31%	95	21w	0.48	1.78	0.00

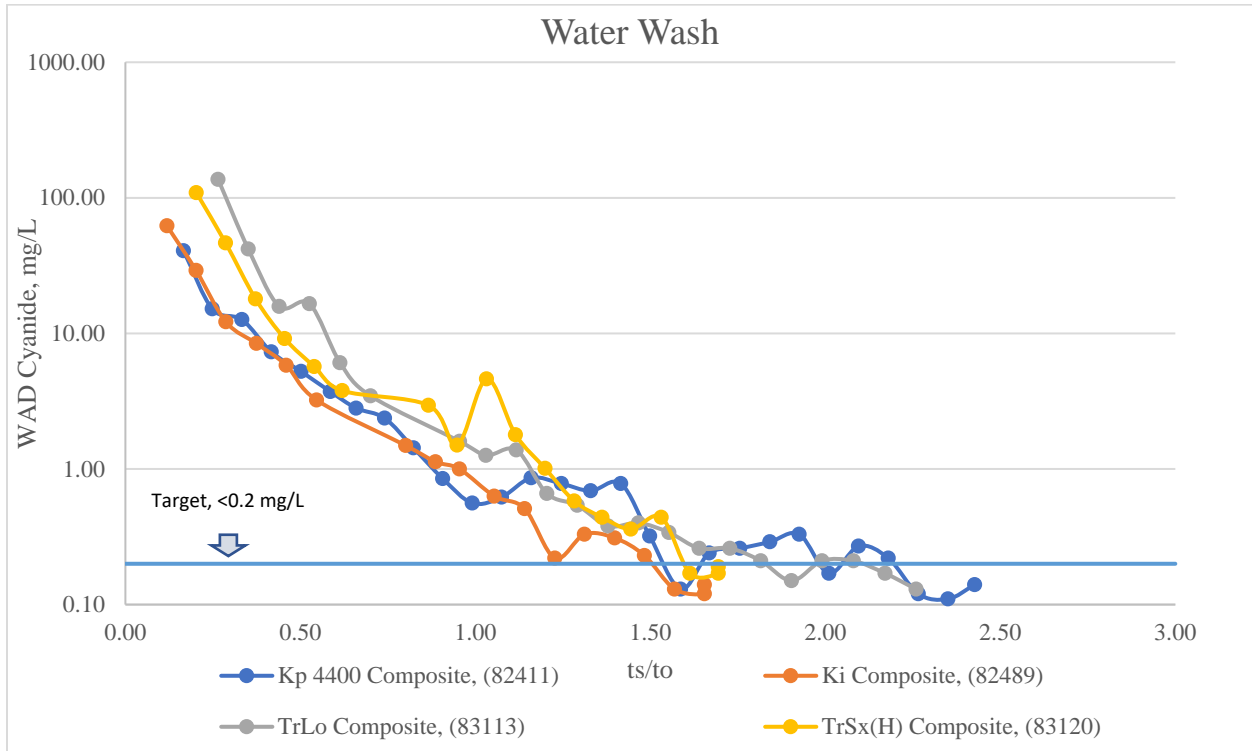

Figure 13.6 Water Wash Summary

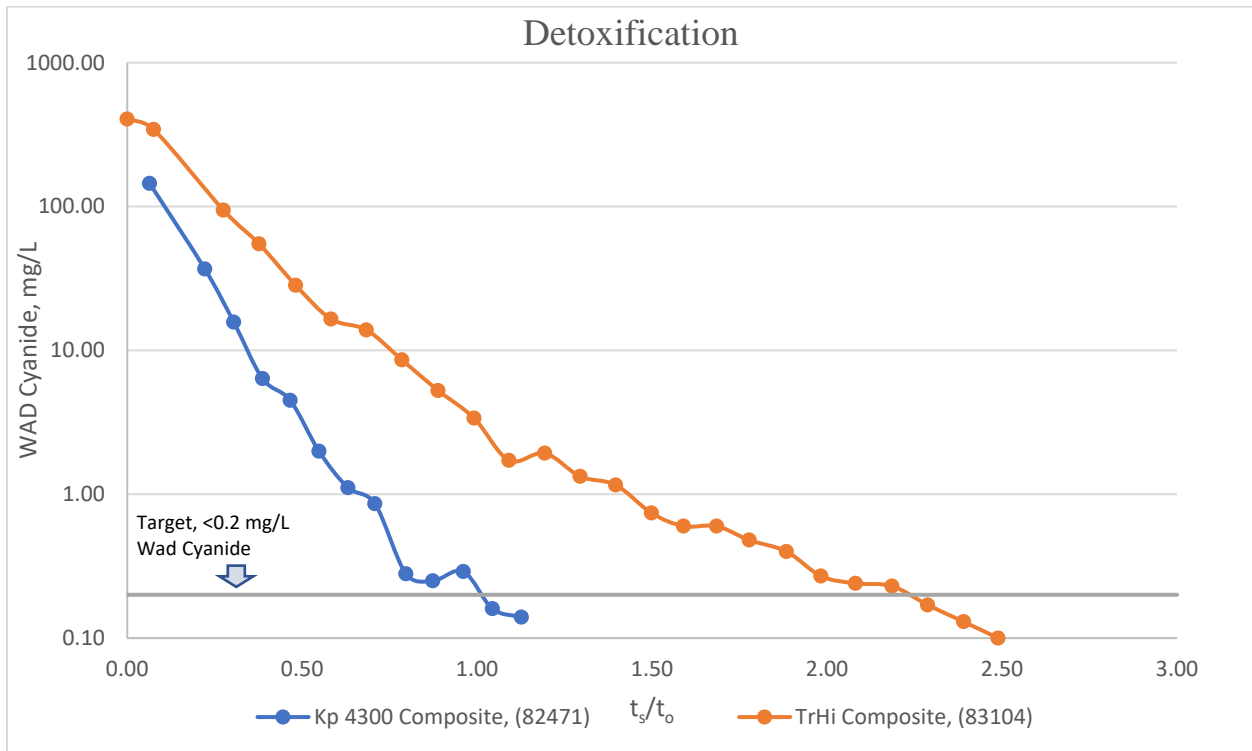

Figure 13.7 Detoxification Summary, INCO SO₂

13.3.1.5 Kappes, Cassiday & Associates (2019) – Diagnostic Leach Test Work

Diagnostic leach testing was utilized to determine the metal association within the column tailings material for composites Kp 4500/4650 and Ki by leaching the material in five (5) sequential stages with various pre-treatments. A 1,000-gram portion of the column tailings material was pulverized to a target size of 80% passing 0.075 millimetres and utilized for the initial agitated leaching stage. For each additional sequential stage, the entire tails residue was utilized.

The results of the diagnostic leach testing for gold and silver extraction are summarized in Table 13-42. A chart summarizing the extractions from the individual phases of leaching is presented in Figure 13.8.

Table 13-42
Diagnostic Leach Test Summary – KCA 2019

Kp 4500/4650 Composite - Column Tail Assay 0.171 g/t Au

KCA Sample No.	KCA Test No.	Metal Association	Calculated Head, g/t Au	Au Extracted, %	Cumulative Extracted, %
82483	83183 A	Direct Cyanide Soluble Gold	0.179	63%	63%
	83184 A, C	Calcite	0.067	4%	66%
	83185 A, C	Dolomite and Iron Oxide	0.060	11%	78%
	83186 A, C	Pyrites and Sulphides	0.040	2%	80%
	83187 A	Carbonaceous	0.036	0%	80%
	--	Encapsulated Gold	--	20%	100%
	Overall	--	0.179	100%	--

Ki Composite - Column Tail Assay 0.101 g/t Au

KCA Sample No.	KCA Test No.	Metal Association	Calculated Head, g/t Au	Au Extracted, %	Cumulative Extracted, %
82492	83183 B	Direct Cyanide Soluble Gold	0.131	54%	54%
	83184 B, D	Calcite	0.060	10%	64%
	83185 B, D	Dolomite and Iron Oxide	0.047	20%	86%
	83186 B, D	Pyrites and Sulphides	0.021	2%	88%
	83187 B	Carbonaceous	0.019	0%	88%
	--	Encapsulated Gold	--	15%	100%
	Overall	--	0.131	100%	--

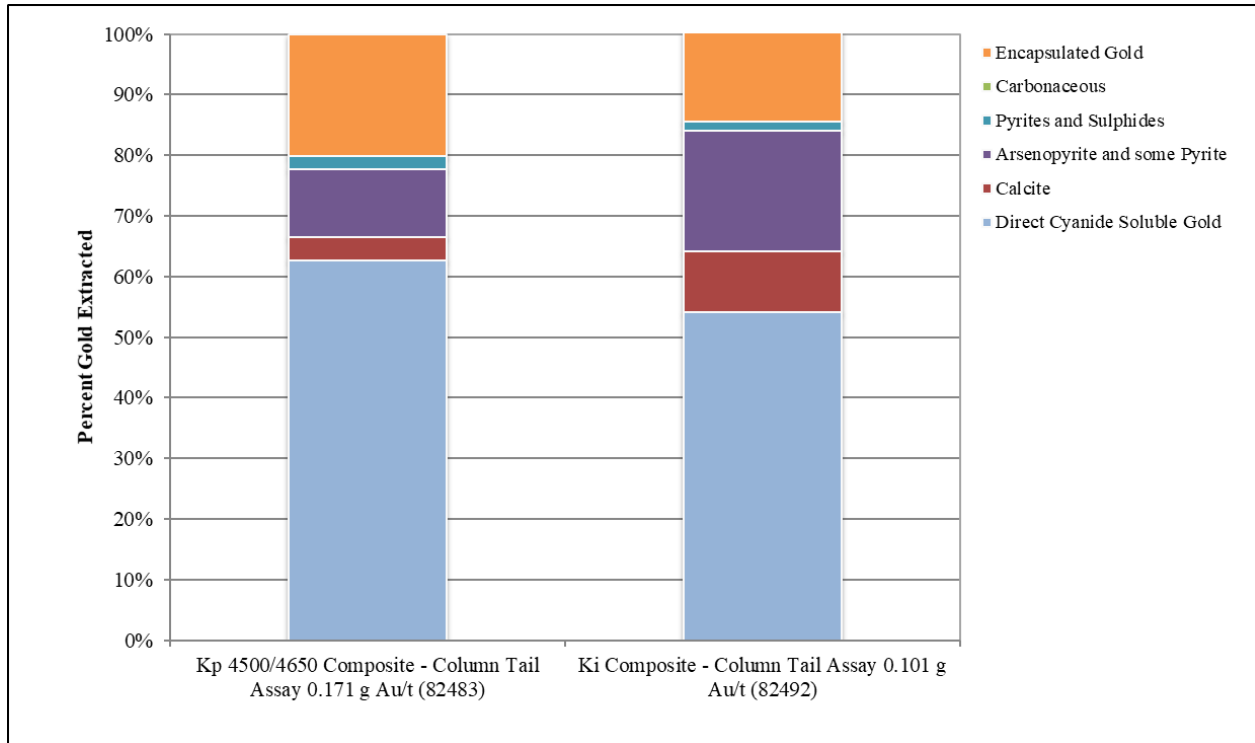

Figure 13.8 Diagnostic Leach Results Summary – KCA 2019

The diagnostic leaching indicates that the majority of the reduced recovery is associated with encapsulation of the metals and none associated with carbonaceous material.

13.3.2 Kappes, Cassiday & Associates (2020)

Preliminary oxidative treatment testwork was conducted by KCA in 2020 to evaluate an alkaline atmospheric oxidation (AAO) process as a pre-treatment for heap leach material. The AAO process is designed to oxidize sulphide material by agglomerating the material with cement and soda ash and circulating an alkaline solution through the material along with air sparging. The alkaline solution is circulated for several weeks; the material is then rinsed with water followed by normal cyanide leaching. The preliminary AAO test program included two column leach tests on Trans-Lo material crushed to -9.5 mm (one with AAO pre-treatment and one without). The AAO pre-treated column achieved 11% higher recovery compared to the column without pre-treatment suggesting that there may be an opportunity to increase recoveries on transition and mixed sulphide material with AAO pre-treatment. Additional test work is required to confirm these results and optimize reagent requirements for the process and will need to be completed before any evaluations of potential economic benefits can be made.

13.4 Conclusions from Metallurgical Programs

Based on the metallurgical tests completed on the Project, key design parameters for the Project include:

- Crush size of 100% passing 38mm (P₈₀ 28mm).
- Estimated gold recoveries (including 2% field deduction) of:
 - 70% for Kp Oxide;
 - 56% for Ki Oxide;
 - 60% for Trans-Hi; and
 - 40% for Trans-Lo
- Estimated silver recoveries (including 3% field deduction) of:
 - 11% for Kp Oxide;
 - 15% for Ki Oxide;
 - 27% for Trans-Hi; and
 - 34% for Trans-Lo.
- Design leach cycle of 80 days.
- Agglomeration with cement not required for permeability or stability.
- Average cyanide consumption of 0.35 kg/t ore.
- Average lime consumption of 1.25 kg/t ore.

The key design parameters are based on a substantial number of metallurgical tests including 107 column leach tests with 85 of the columns being performed on samples representative of domains in the current deposit model. These 85 representative samples from documented drill holes with good spatial distribution in the proposed pit include 41 columns tests on Kp Oxide material, 7 column tests on Ki Oxide material, 16 column tests on Trans-Hi material and 21 column tests on Trans-Lo material. The 22 non-representative columns were excluded based on the following criteria:

- Column on Trans-S or sulphide material which is not considered in the Mineral Reserve.
- Mix of Tran-S or other material types.
- Samples taken from outside of the proposed pit area.

An additional 54 bottle roll leach tests with direct correlations with the column tests have been included as part of the evaluation to support these results and conclusions, which are detailed in the following sections.

In general, the Camino Rojo deposit shows variability in gold and silver recoveries based on material type and geological domain with preg-robbing organic carbon being the only significant deleterious element identified, which is primarily associated with the transition material at depth

along the outer edges of the deposit. Recoveries for the oxide material are good and will yield acceptable results using conventional heap leaching methods with cyanide. Recoveries for the transition material are lower compared with the oxide material for conventional leaching with some areas of transition showing reasonably high recoveries. Reagent consumptions for all material types are reasonably low.

Preg robbing presents a low to moderate risk to the overall Project; however, a significant investigation by Orla into the preg robbing material as well as preg-robbing test work completed by KCA indicates that preg robbing material will most likely not be encountered until later in the Project life and can be mitigated by proper ore control.

13.4.1 Crush Size and Recovery

The column leach recovery by crush size was analysed to determine the effect of crush size on recovery for each material type. Column tests were conducted on crushed product sizes ranging from a P₈₀ of 7mm to a P₈₀ of nearly 118mm (P₈₀ sizes were estimated for the SGS data set). These data were aggregated and plotted against recoveries for both gold and silver for each material classification type. Trend lines were then used to establish projected recoveries. Crushed product size vs. recovery results are presented in Figure 13.9 through Figure 13.12 for Kp Oxide, Ki Oxide, Trans-Hi and Trans-Lo material types, respectively.

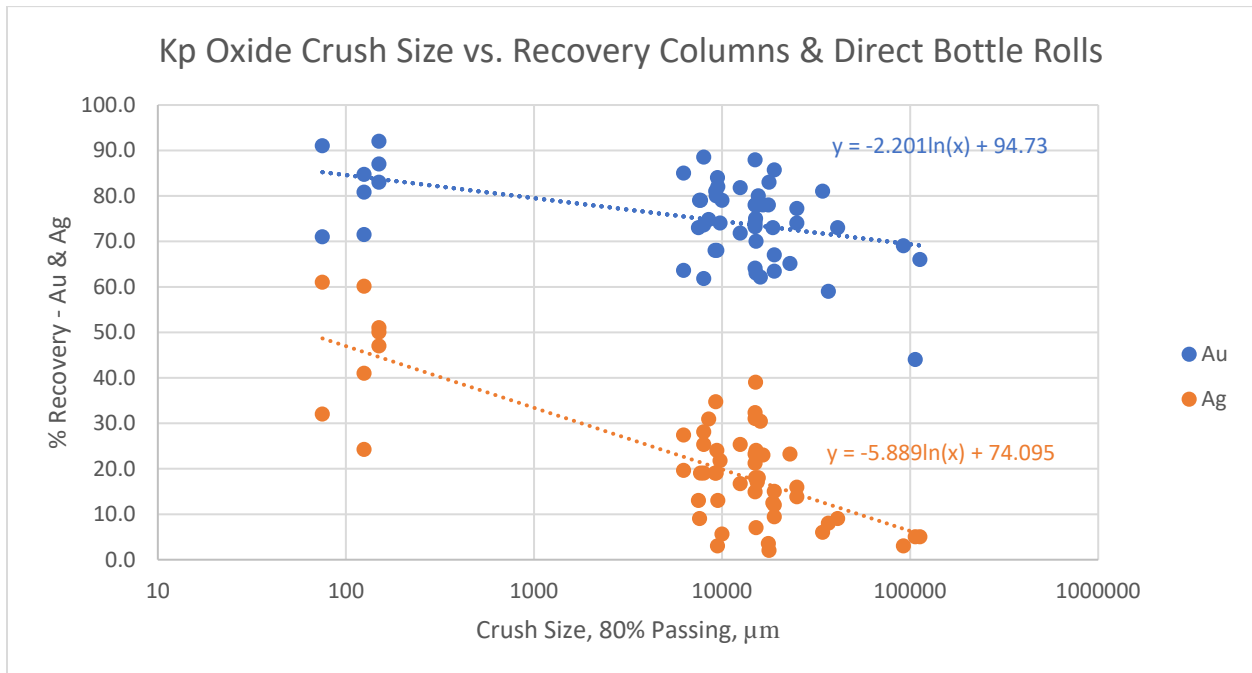

Figure 13.9 Kp Oxide Recovery vs. Crush Size

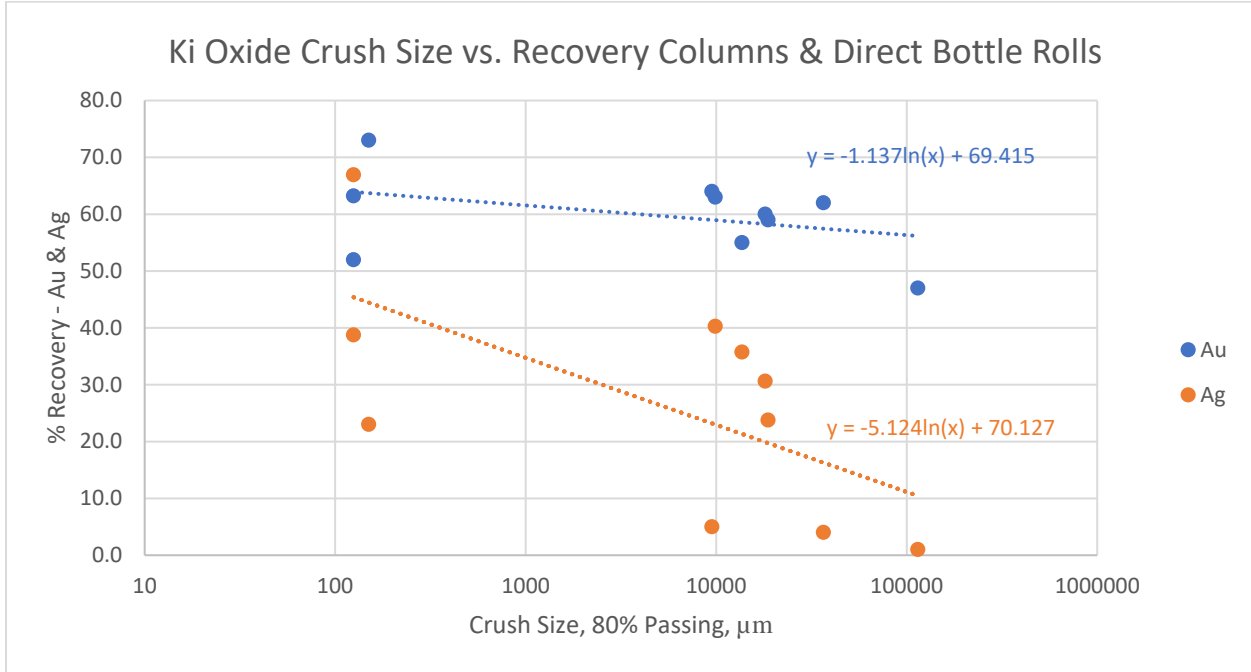

Figure 13.10 Ki Oxide Recovery vs. Crush Size

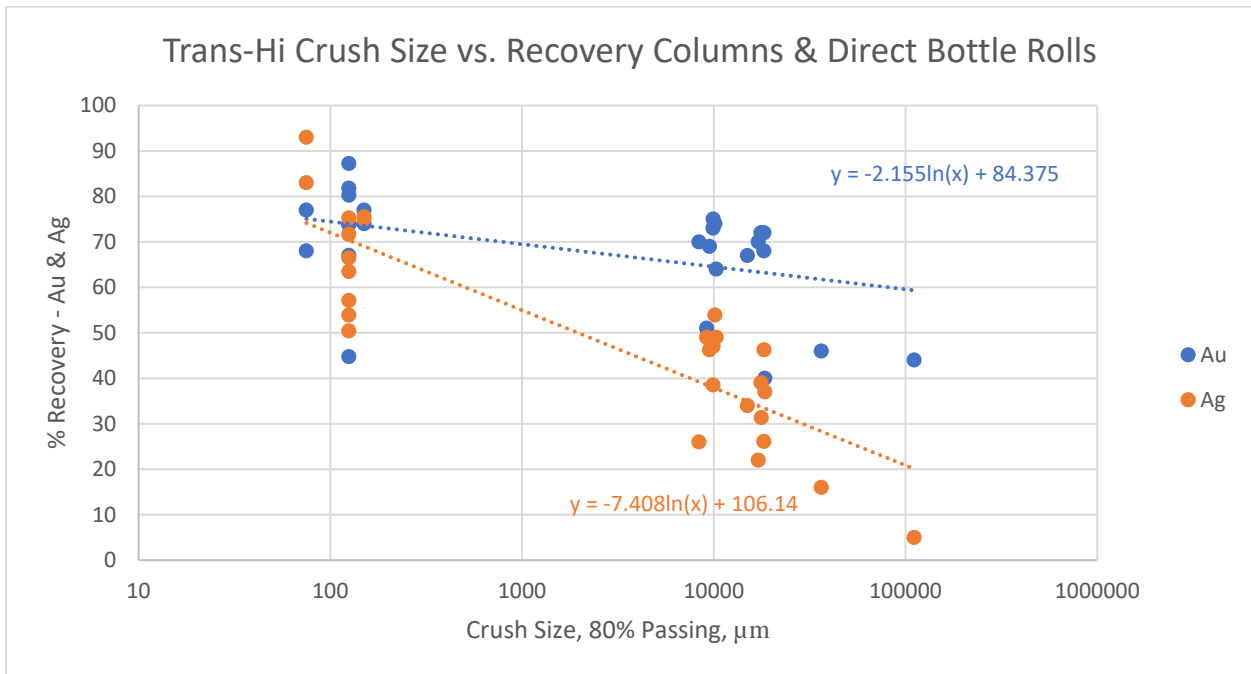

Figure 13.11 Trans-Hi Recovery vs. Crush Size

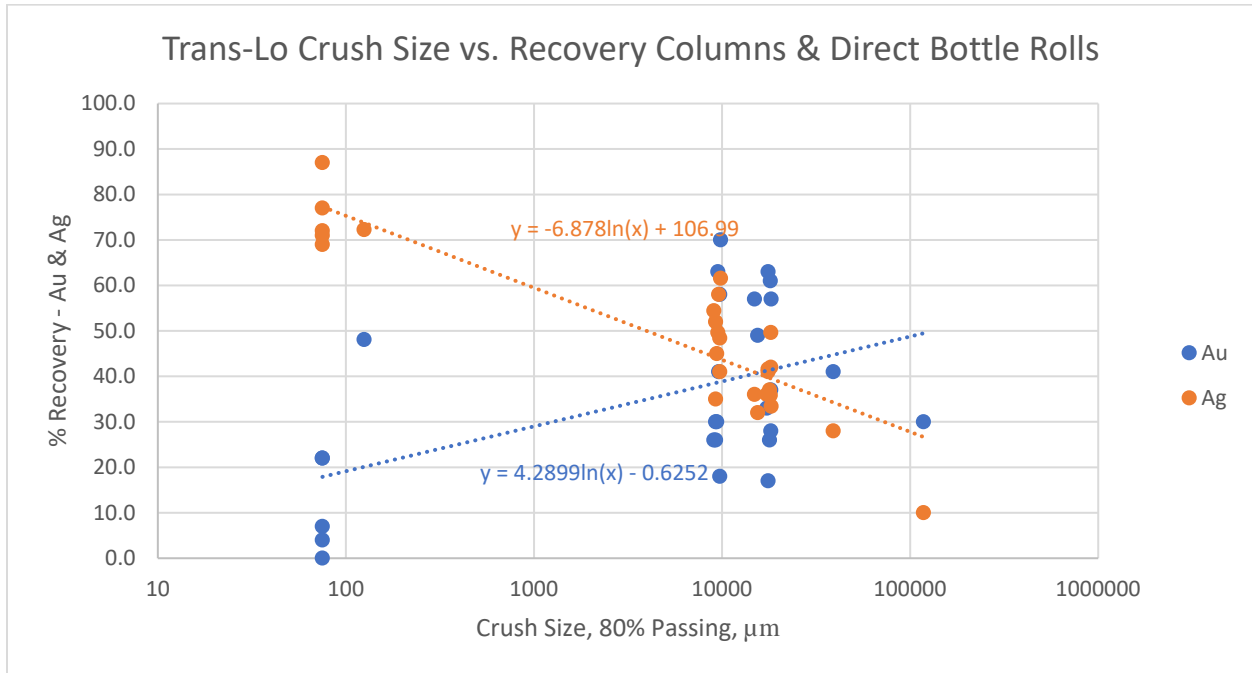

Figure 13.12 Trans-Lo Recovery vs. Crush Size

Results from the test work generally show improved recoveries with finer crushing with decreasing recovery improvements for gold at crush sizes finer than P₈₀ 25mm. Silver recoveries were significantly more sensitive to crush size than gold recoveries.

Based on the metallurgical test data, KCA recommends a crushed product size of 100% passing 38mm (P₈₀ ~28mm) in order to minimize crushing requirements and recover most of the recoverable gold and silver. Estimated recoveries by material type at P₈₀ 28mm, including a 2% field deduction for gold and 3% field deduction for silver, are presented in Table 13-43.

**Table 13-43
Estimated Recoveries by Material Type for P₈₀ 28mm Crush Size**

Material Type	Au	Ag
Kp Oxide	70%	11%
Ki Oxide	56%	15%
Transition-hi	60%	27%
Transition-lo	40%	34%

13.4.2 Leach Cycle

The Camino Rojo leach cycle has been estimated based on the column test work completed by evaluating the leach curves for gold and silver. The leach cycle considers tonnes of solution per tonne of material as well as total time required to reach the ultimate recovery in the column leach tests. Based on this data, the estimated leach cycle for the Camino Rojo material is 80 days. The expected tonnes of solutions per tonne of ore after the 80-day leach cycle is approximately 1.32. The recommended leach cycle is primarily based on the time required to leach and recover gold. The column tests indicate that silver leaches slower and increased silver recoveries would be expected with longer leach cycles.

13.4.3 Reagent Consumption Projection

13.4.3.1 Cyanide

The column leach test cyanide consumptions were studied by material type and adjusted to provide a basis for the expected field cyanide consumptions. In KCA's experience, field cyanide consumptions are typically 25% to 50% of observed lab consumptions and have been estimated at 35% of the lab consumptions for this Technical Report. The projected field consumptions by material type are shown in the Table 13-44.

Table 13-44
Projected Field Cyanide Consumptions by Material Type

Material Type	NaCN Cons. kg/t
Kp Ox	0.32
Ki Ox	0.38
Trans-Hi	0.37
Trans-Lo	0.37
Wt. Avg., All	0.35

For the purposes of this Technical Report, the weighted average NaCN consumption based on total tonnes of ore is estimated 0.35 kg/t ore.

13.4.3.2 Lime

Lime is required for pH control during leaching. Because hydrated lime was utilized in the lab leach tests, the laboratory lime consumptions are adjusted to accurately predict consumptions of quicklime (pebble lime, CaO) in the field. Estimated quicklime consumptions by material type are presented in Table 13-45.

**Table 13-45
Projected Field Lime Consumptions by Material Type**

Material Type	Quicklime Cons. kg/t
Kp Ox	1.26
Ki Ox	1.16
Trans-Hi	1.24
Trans-Lo	1.32
Wt. Avg. All	1.25

To ensure that proper pH is maintained throughout the heap, a lime consumption of 1.25 kg/t ore has been selected.

13.5 Preg Robbing Discussion

Preg robbing is a phenomenon where gold and gold-cyanide complexes are preferentially absorbed by carbonaceous, and to a lesser extent, other material. In addition to the direct vs. CIL bottle roll tests and cyanide shake tests completed by KCA to evaluate the potential for preg-robbing, an extensive campaign was completed by Orla and reviewed by KCA to further understand the preg robbing mechanism and affected material types and areas. The program included 828 tests completed on samples from drillhole intercepts in 2018 and 2019 which were evaluated for Au (CN) recovery, preg-robbing and organic carbon. Another 3,960 composite core samples tested by Goldcorp for organic carbon and preg-robbing were used as reference, though the majority of these were from the sulphide portion of the deposit.

Key observations from the preg robbing test work include:

- Overall, no strong correlation between organic carbon content and preg-robbing material. The correlation is more pronounced in less oxidized material.
- Preg robbing not strongly associated with Oxide material with less than 3% of tests showing preg rob values above 10%. Most of these are on samples taken from areas of waste in the current mine model.
- Higher preg rob values generally associated with the Trans-Lo material.

- Preg robbing appears to be primarily at depth in the transition material along the outer margins of the deposit.
- Approximately 6% of the recovered gold in the feasibility production model comes from areas with more than 10% preg-robbing test results. Material from these areas will be mined starting in year 3.
- 80% of the material from areas with greater than 10% preg-robbing test results that is planned to go to the heap is Trans-Lo.

Interbedded shale and sandstone layers of the Caracol Formation that host the Camino Rojo deposit contain variable amounts of organic carbon derived from the sediments that formed the rocks. During the alteration and mineralizing events that formed the deposit, the carbon was mobilized and depleted in the core of the deposit. Carbonate was similarly depleted, while potassium was increased through metasomatism, resulting in a high potassium, low carbonate and low carbon core to the deposit. In the outer parts of the deposit, and peripheral to it, organic carbon is still present. It typically occurs as grey/black, wispy, flattened, millimetre sized clots, lenses or layers in darker shale horizons. It is locally sub-graphitic and weakly sheared along mm-cm calcite rich bedding planes.

Spatial plots of organic carbon (OC) content confirm that higher organic carbon contents occur in the outer part of the deposit with an OC depleted zone in the centre. The Kp domain, which forms the central part of the deposit, is therefore generally lower in organic carbon than the Ki domain that surrounds it.

Overall, data shows a weak positive correlation between organic carbon and preg-robbing, but with significant variability (Figure 13.13). When results are divided by oxidation level, it is evident that in oxide material organic carbon most commonly does not cause preg-robbing conditions. This is postulated to be because the carbon has already been neutralized by absorbing other elements during the weathering process. In Trans_ Lo and Trans_sx material, there is a much stronger correlation between organic carbon and preg-robbing. Carbon, when present, is still available to absorb the gold. Correlation in Transition_Hi is between oxide and Transition_Lo as would be expected.

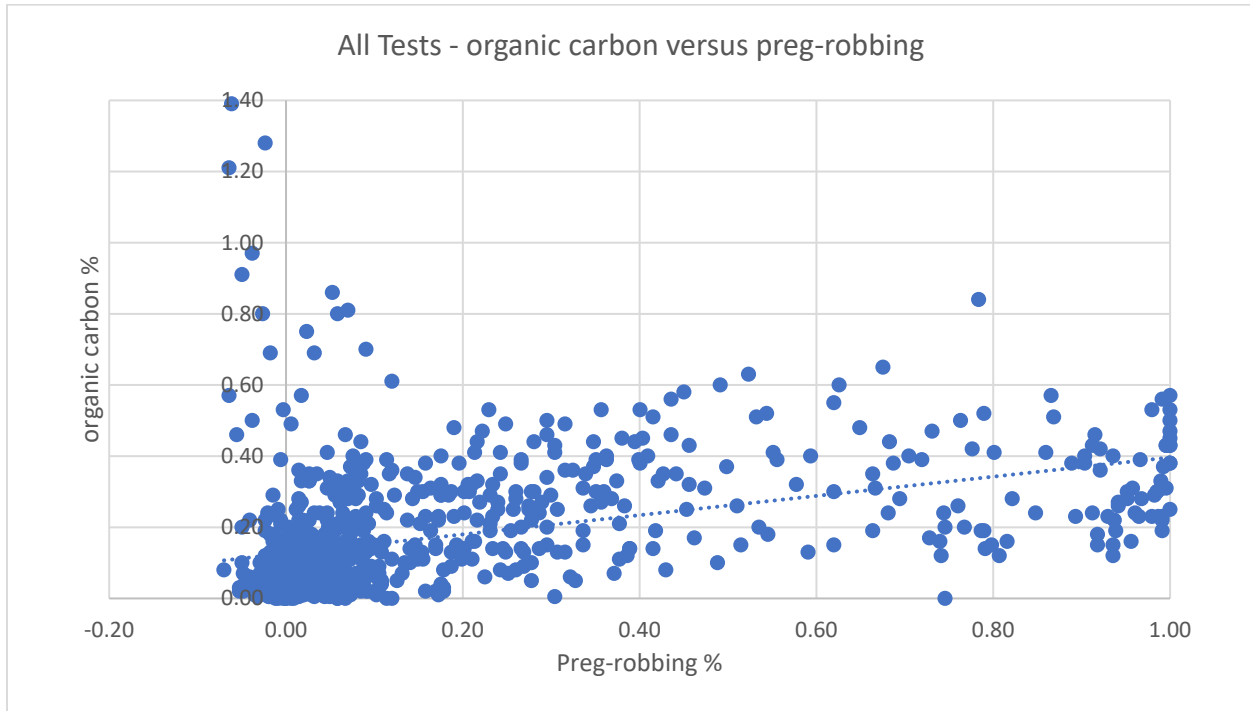

Figure 13.13 Organic Carbon Versus Preg-Robbing

KCA considers preg-robbing values greater than 10% to be potentially problematic. Spatial analysis of the preg-robbing test results was undertaken and areas where most samples have greater than 10% preg-robbing results outlined. This indicates approximately 6.3 million tonnes, or 9.4%, of the 67.4 million tonnes of material going to the heap leach pad in the Feasibility Study mine schedule comes from areas with potential preg-robbing issues. The average grade is 0.69 g/t Au, representing 8.8% of the total contained gold ounces in the schedule. However, 80% of this material is Trans_Lo which has a lower recovery than other material. Therefore, estimated recovered gold from areas with greater than 10% preg-robbing is 6% of the total. Material that is potentially problematic does not come into the mine plan until year 3. Figure 13.14 shows areas with +10% peg-robbing test results.

Not all of the material with greater than 10% preg-robbing test results is expected to actually be preg-robbing. In the 2015 column test program, preg-robbing testing was performed on the composite material and material with 40 to 60% preg-robbing results had 55 to 72% Au recovery. See Figure 13.15. These results show that higher preg-robbing results do not necessarily indicate recovery problems.

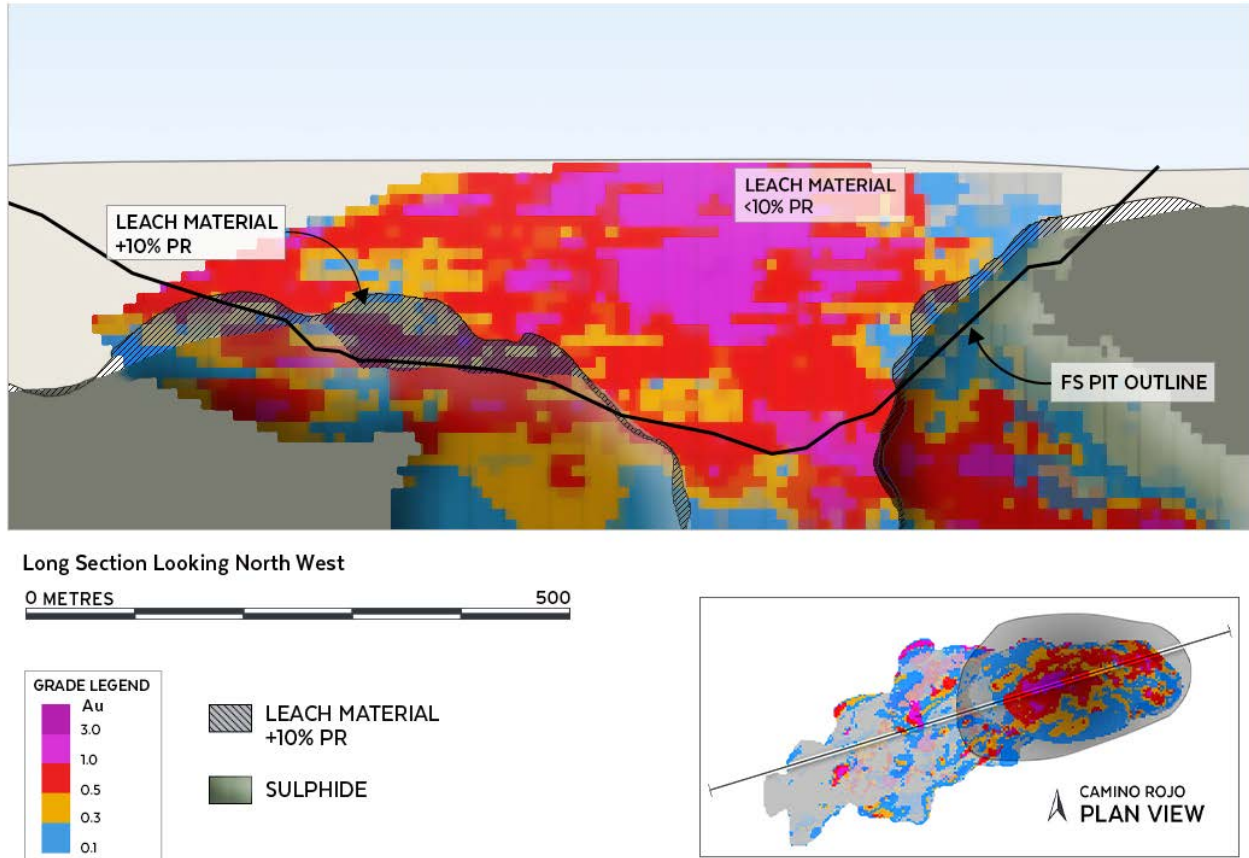

Figure 13.14 Areas with +10% Preg-Robbing Test Results

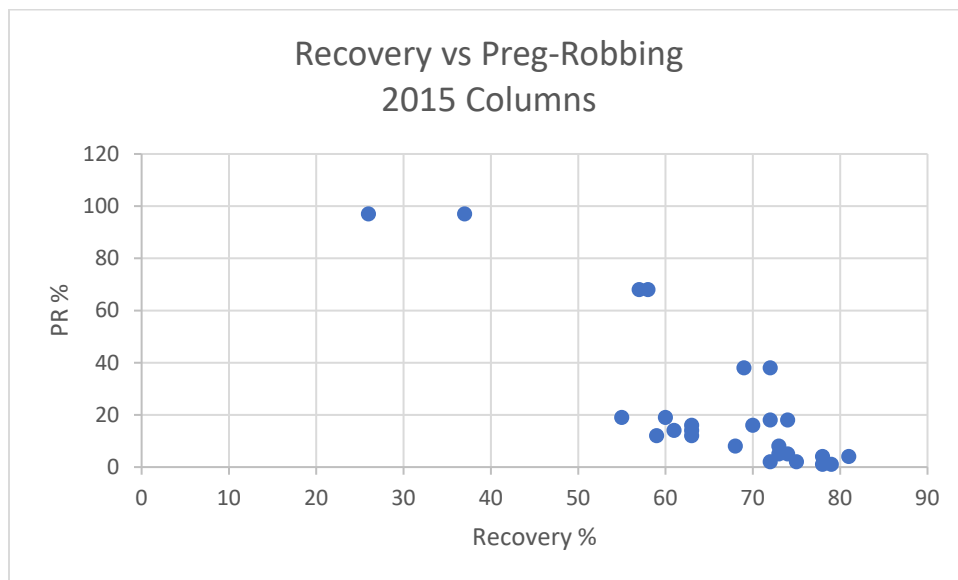

Figure 13.15 Recovery Versus Preg-Robbing

Because the correlation between preg-robbing tests and actual recovery problems is not certain and tests show that at least some material with high preg-robbing results will still get good recoveries, further testing of the material identified as potentially preg-robbing is recommended before this material is mined. This should include column testing.

If there is still uncertainty during mining, potentially preg-robbing material should be stockpiled separately and tested further. If additional test work confirms the material is preg-robbing, it should either be put in the waste pile or on the top of the heap at the end of mine life.

13.6 Sulphide Mineralization Discussion

Metallurgical testing on the sulphide resource (Trans-S) has indicated that the material is not amenable to direct cyanide leaching with average gold recoveries of less than 25% and silver recoveries around 26%; however, the mineralization has demonstrated that gold, silver, zinc and lead can be recovered into concentrates that are of potentially marketable grade.

A possible process flowsheet for a sequential flotation process consists of an initial pre-flotation to remove organic carbon followed by lead flotation, zinc flotation, and pyrite/arsenopyrite flotation to recover additional precious metals. The pyrite/arsenopyrite concentrate would be oxidized to recover additional gold and silver by cyanide leaching. Payable products would be the Lead Concentrate, Zinc Concentrate, and Gold Silver doré recovered from the cyanide leaching of the pyrite/arsenopyrite concentrate. It is assumed that after oxidation 90% of the gold and silver can be recovered from the oxidized pyrite concentrate. Waste products would be the pre-flotation concentrate, the flotation tailings, and the leached residue of the pyrite/arsenopyrite concentrate. Table 13-46 presents the distribution of metals to the various products based on preliminary test work.

Note that the sulphide material is not included as part of the Mineral Reserve for this Technical Report and these numbers are only presented to provide guidance as to whether material could potentially be a Mineral Resource. The process flowsheet described above is based on commonly used metal recovery methods and the metallurgical test work to date is too preliminary to confirm these recoveries can be achieved or to determine the economic viability of the material.

Table 13-46
Distribution of Metals to Various Sulphide Products Based on Preliminary Test Work

Product	Wt. %	Distribution %			
		Pb	Zn	Au	Ag
Flotation Feed	100	100	100	100	100
Lead Concentrate	0.3	60	1	49	44
Zinc Concentrate	0.6	1	64	2	7
Pyrite Concentrate	19.6	(15)	(19)	(39)	(28)
Dore from leaching Pyrite Con	NA	NA	NA	35	25
Total Recovery for resource estimate		60%	64%	86%	76%
Pre-flotation Concentrate	4.4	14	6	6	16
Pyrite Leach Residue	19.6	15	19	4	3
Flotation Tailings	75.1	10	10	4	5

14.0 MINERAL RESOURCE ESTIMATES

14.1 Mineral Resource

No update to the Mineral Resource estimate was made as part of this updated Feasibility Study. The Mineral Resource estimate dated June 7, 2019 remains current. Table 14-1 presents the gold and silver Mineral Resource estimate for the Camino Rojo Project. Measured and Indicated Mineral Resources amount to 353.4 million tonnes at 0.832 g/t gold and 8.83 g/t silver. Contained metal amounts to 9.46 million ounces gold and 100.4 million ounces of silver for Measured and Indicated Mineral Resources. Inferred Mineral Resource is an additional 60.9 million tonnes at 0.866 g/t gold and 7.41 g/t silver. Contained metal amounts to 1.70 million ounces of gold and 14.5 million ounces of silver for the inferred Mineral Resource. There has been no new drilling for the Mineral Resource estimation since the 2019 Technical Report and, accordingly, the Mineral Resource estimate is the same as presented in the 2019 Technical Report

The gold and silver Mineral Resource includes material amenable to heap leach recovery methods (leach material) and material amenable to mill and flotation concentration methods (mill material). For the leach material, Measured and Indicated Mineral Resources amount to 94.6 million tonnes at 0.71 g/t gold and 12.7 g/t silver and contained metal amounts to 2.16 million ounces gold and 38.8 million ounces of silver. Inferred Mineral Resource is an additional 4.4 million tonnes at 0.86 g/t gold and 5.8 g/t silver and contained metal amounts to 119,800 ounces of gold and 805,000 ounces of silver for the Inferred Mineral Resource in leach material. The leach Mineral Resources are oxide dominant and are the focus of the Feasibility Study.

For the gold and silver resource in mill material, Measured and Indicated Mineral Resources amount to 258.8 million tonnes at 0.88 g/t gold and 7.4 g/t silver and contained metal amounts to 7.30 million ounces gold and 61.6 million ounces of silver. Inferred Mineral Resource is an additional 56.6 million tonnes at 0.87 g/t gold and 7.5 g/t silver and contained metal amounts to 1.58 million ounces of gold and 13.7 million ounces of silver for the Inferred Mineral Resource in mill material.

Table 14-2 presents the zinc and lead Mineral Resource estimate for the Camino Rojo Project. The zinc and lead Mineral Resources are in sulphide dominant material and are recovered along with the gold and silver in the mill material. Zinc and lead Measured and Indicated Mineral Resources amount to 258.8 million tonnes at 0.26% zinc and 0.07% lead. Contained metal amounts to 1.50 billion pounds of zinc and 413.6 million pounds of lead for the Measured and Indicated Mineral Resource. Inferred Mineral Resource is an additional 56.6 million tonnes at 0.23% zinc and 0.05% lead. Contained metal amounts to 290.4 million pounds of zinc and 63.1 million pounds of lead for the Inferred Mineral Resource category.

The Mineral Resources from the leach material are reported inclusive of those Mineral Resources that were converted to Mineral Reserves presented in Section 14.0. The Mineral Resources from the mill material were excluded from the mine design in the Feasibility Study.

The Mineral Resource estimates are based on a block model developed by IMC during January and February 2019. This updated model incorporated the 2018 Orla drilling and updated geologic models.

The Measured, Indicated, and Inferred Mineral Resources reported herein are contained within a floating cone pit shell to demonstrate “reasonable prospects for eventual economic extraction” to meet the definition of Mineral Resources in NI 43-101.

Figure 14.1 shows the constraining pit shell that is based on Measured, Indicated, and Inferred Mineral Resource.

**Table 14-1
Mineral Resource Estimate – Gold and Silver (Inclusive of Mineral Reserve)**

Resource Type	NSR Cut-off (\$/t)	Kt	Gold (g/t)	Silver (g/t)	Gold (koz)	Silver (koz)
Leach Resource:						
Measured Mineral Resource	4.73	19,391	0.77	14.9	482.3	9,305
Indicated Mineral Resource	4.73	75,249	0.70	12.2	1,680.7	29,471
Meas/Ind Mineral Resource	4.73	94,640	0.71	12.7	2,163.0	38,776
Inferred Mineral Resource	4.73	4,355	0.86	5.8	119.8	805
Mill Resource:						
Measured Mineral Resource	13.71	3,358	0.69	9.2	74.2	997
Indicated Mineral Resource	13.71	255,445	0.88	7.4	7,221.4	60,606
Meas/Ind Mineral Resource	13.71	258,803	0.88	7.4	7,295.6	61,603
Inferred Mineral Resource	13.71	56,564	0.87	7.5	1,576.9	13,713
Total Mineral Resource						
Measured Mineral Resource		22,749	0.76	14.1	556.5	10,302
Indicated Mineral Resource		330,694	0.84	8.5	8,902.1	90,078
Meas/Ind Mineral Resource		353,443	0.83	8.8	9,458.6	100,379
Inferred Mineral Resource		60,919	0.87	7.4	1,696.7	14,518

**Table 14-2
Mineral Resource Estimate – Zinc and Lead**

Resource Type	NSR Cut-off (\$/t)	Kt	Lead (%)	Zinc (%)	Lead (Mlb)	Zinc (Mlb)
Mill Resource:						
Measured Mineral Resource	13.71	3,358	0.13	0.38	9.3	28.2
Indicated Mineral Resource	13.71	255,445	0.07	0.26	404.3	1,468.7
Meas/Ind Mineral Resource	13.71	258,803	0.07	0.26	413.6	1,496.8
Inferred Mineral Resource	13.71	56,564	0.05	0.23	63.1	290.4

Notes:

- The Mineral Resource estimate has an effective date of 7 June 2019 and the estimate was prepared using the definitions in CIM Definition Standards (10 May 2014).
- All figures are rounded to reflect the relative accuracy of the estimate and therefore numbers may not appear to add precisely.
- Mineral Resources that are not Mineral Reserves do not have demonstrated economic viability.
- Mineral Resources for leach material are based on prices of \$1400/oz gold and \$20/oz silver.
- Mineral Resources for mill material are based on prices of \$1400/oz gold, \$20/oz silver, \$1.05/lb lead, and \$1.20/lb zinc.
- Mineral Resources are based on NSR cut-off of \$4.73/t for leach material and \$13.71/t for mill material.
- NSR value for leach material is as follows:
Kp Oxide: NSR (\$/t) = 30.77 x gold (g/t) + 0.068 x silver (g/t), based on gold recovery of 70% and silver recovery of 11%.
Ki Oxide: NSR (\$/t) = 24.61 x gold (g/t) + 0.092 x silver (g/t), based on gold recovery of 56% and silver recovery of 15%.
Tran-Hi: NSR (\$/t) = 26.37 x gold (g/t) + 0.166 x silver (g/t), based on gold recovery of 60% and silver recovery of 27%.
Tran-Lo: NSR (\$/t) = 17.58 x gold (g/t) + 0.209 x silver (g/t), based on gold recovery of 40% and silver recovery of 34%.
- NSR value for mill material is 36.75 x gold (g/t) + 0.429 x silver (g/t) + 10.75 x lead (%) + 11.77 x zinc (%), based on recoveries of 86% gold, 76% silver, 60% lead, and 64% zinc.
- Table 14-3 accompanies this Mineral Resource statement and shows all relevant parameters.
- Includes 2% NSR royalty and an USD:MXN exchange rate of 19.3.
- Mineral Resources are reported in relation to a conceptual constraining pit shell in order to demonstrate reasonable prospects for eventual economic extraction, as required by the definition of Mineral Resource in NI 43-101; mineralization lying outside of the pit shell is excluded from the Mineral Resource.
- The Mineral Resource estimate assumes that the floating pit cone used to constrain the estimate extends onto land held by Fresnillo. Any potential development of the Camino Rojo Project that includes an open pit encompassing the entire Mineral Resource estimate would be dependent on obtaining an agreement with Fresnillo (in addition to the Layback Agreement, which is only with respect to a portion of the heap leach material included in the Mineral Reserve)
- The Mineral Resources in the leach material are inclusive of those Mineral Resources that were converted to Mineral Reserves.

14.1.1 Metal Prices for Mineral Resources

Table 14-3 shows the economic and recovery parameters for the Mineral Resource estimate. Metal prices for the Mineral Resource estimate are US\$1400 per ounce gold, US\$20 per ounce silver, US\$1.05 per pound lead, and US\$1.20 per pound zinc. IMC believes these prices to be reasonable based on: 1) historical 3-year trailing averages, 2) prices used by other companies for comparable projects, and 3) long range consensus price forecasts prepared by various bank economists.

14.1.2 Cost and Recovery Estimates for Mineral Resources

The mining cost is estimated at US\$1.65 per total tonne. This was estimated by IMC and is based on owner operation of the mining fleet. This includes an allowance of US\$0.05 per tonne for pit dewatering.

Table 14-3 shows parameters for six material types. Note that costs used for the resource estimation vary somewhat from the costs estimated in the Feasibility Study because the resource was done earlier and the Feasibility Study does not consider the sulphide material. The costs used in the Mineral Resource estimation were only used to demonstrate “reasonable prospects for eventual economic extraction”. For the first four materials, Kp Oxide, Ki Oxide, Transitional

High Oxide, and Transitional Low Oxide, it is assumed that processing will be by crushing and heap leaching. The processing and G&A costs of US\$3.413 and US\$1.319 per processed tonne respectively were provided by KCA and are based on a process production rate of 18,000 tonnes per day or about 6.57 million tonnes per year.

KCA provided the recovery estimates for gold and silver shown in Table 14-3. These estimates consider both the historical and recent metallurgical testing data.

IMC assumed 100% refinery payables for this case. The gold and silver refining costs are also IMC estimates. The leach material is also subject to a 2% NSR royalty. Zinc and lead do not contribute to economics for leach material.

Due to two products, and also variable recoveries by material type, an NSR value was calculated for each block to tabulate proposed quantities of mineralized material. The gold and silver NSR factors for Kp Oxide are calculated as follows:

$$\text{Gold NSR Factor} = (\$1400 - \$5.00) \times 0.70 \times 1.00 \times 0.98 / 31.103 = \$30.768/\text{t}$$

$$\text{Silver NSR Factor} = (\$20 - \$0.50) \times 0.11 \times 1.00 \times 0.98 / 31.103 = \$0.0676/\text{t}$$

The units are US\$ per gram per tonne. The 0.98 constant represents an allowance for the royalty cost.

The NSR value for a block is calculated as:

$$\text{NSR} = \$30.768 \times \text{gold grade} + \$0.0676 \times \text{silver grade}$$

The breakeven NSR cut-off is US\$6.38 per tonne, the mining + process + G&A cost. The internal NSR cut-off is US\$4.73 per tonne, the process + G&A cost. Internal cut-off applies to blocks that have to be removed from the pit, so mining is a sunk cost. Note the NSR cut-off does not vary by material type for the heap leach materials, so is convenient for mine planning and scheduling.

The parameters and cut-offs for the other material types are also shown in Table 14-3.

**Table 14-3
Economic Parameters for Mineral Resource Estimate**

Material Type	Units	Kp Oxide	Ki Oxide	Tran-Hi	Tran-Low	Tran-S	Sulphide	Waste
Commodity Prices								
Gold Price Per Ounce	(US\$)	1400	1400	1400	1400	1400	1400	
Silver Price Per Ounce	(US\$)	20.00	20.00	20.00	20.00	20.00	20.00	
Lead Price Per Pound	(US\$)	1.05	1.05	1.05	1.05	1.05	1.05	
Zinc Price Per Pound	(US\$)	1.20	1.20	1.20	1.20	1.20	1.20	
Plant Production Rate	(ktpy)	6,570	6,570	6,570	6,570	9,125	9,125	
Mining Cost Per Tonne								
Owner Mining Cost	(US\$)	1.600	1.600	1.600	1.600	1.600	1.600	1.600
Allowance for Pit Dewatering	(US\$)	0.050	0.050	0.050	0.050	0.050	0.050	0.050
Total Mining Cost	(US\$)	1.650	1.650	1.650	1.650	1.650	1.650	1.650
Process and G&A Cost Per Ore Tonne								
Processing	(US\$)	3.413	3.413	3.413	3.413	12.500	12.500	
G&A	(US\$)	1.319	1.319	1.319	1.319	1.205	1.205	
Total Process and G&A	(US\$)	4.732	4.732	4.732	4.732	13.705	13.705	
Plant Recovery								
Gold	(%)	70%	56%	60%	40%	86%	86%	
Silver	(%)	11%	15%	27%	34%	76%	76%	
Lead	(%)	0%	0%	0%	0%	60%	60%	
Zinc	(%)	0%	0%	0%	0%	64%	64%	
Smelting/Refining Payables and Costs								
Gold Refinery Payable	(%)	100%	100%	100%	100%	95%	95%	
Silver Refinery Payable	(%)	100%	100%	100%	100%	95%	95%	
Lead Smelter Payable	(%)	0%	0%	0%	0%	95%	95%	
Zinc Smelter Payable	(%)	0%	0%	0%	0%	85%	85%	
Gold Refining Per Ounce	(US\$)	5.00	5.00	5.00	5.00	1.00	1.00	
Silver Refining Per Ounce	(US\$)	0.50	0.50	0.50	0.50	1.50	1.50	
Lead Treatment Per Pound	(US\$)	0.00	0.00	0.00	0.00	0.194	0.194	
Zinc Treatment Per Pound	(US\$)	0.00	0.00	0.00	0.00	0.219	0.219	
Royalties								
Royalty	(%)	2%	2%	2%	2%	0%	0%	
NSR Factors								
Gold NSR Factor	(\$/g)	30.768	24.614	26.372	17.582	36.748	36.748	
Silver NSR Factor	(\$/g)	0.0676	0.0922	0.1659	0.2089	0.4294	0.4294	
Lead NSR Factor	(\$/%)	0.00	0.00	0.00	0.00	10.753	10.753	
Zinc NSR Factor	(\$/%)	0.00	0.00	0.00	0.00	11.770	11.770	
NSR Cut-offs								
Breakeven NSR Cut-off	(\$/t)	6.38	6.38	6.38	6.38	15.36	15.36	
Internal NSR Cut-off	(\$/t)	4.73	4.73	4.73	4.73	13.71	13.71	

Note: Economic parameters used for the Mineral Resource vary slightly from the Feasibility Study economic model as they were done before the final economic analysis.

14.1.3 Parameters for Mill Material

The processing cost for the Transition Sulphide and Sulphide material types is estimated at US\$12.50 per tonne based on grinding and differential flotation to produce a lead, zinc, and a pyrite concentrate. The plant production rate is assumed to be 25,000 tpd or 9.12 million tonnes per year. The overall recoveries for gold and silver are based on the oxidation and cyanide leaching of the pyrite concentrate. The cost for this is included in the process cost estimate. It is assumed the zinc and lead will be recovered as concentrates that will be shipped to conventional smelters. Preliminary estimates of plant recoveries for gold, silver, lead, and zinc are shown in Table 14-3.

Table 14-4 shows typical treatment terms for zinc and lead concentrates, and is the basis for the payable amounts of zinc and lead and treatment charges shown in Table 14-3. Typical concentrate grades are assumed for the calculation but more testing is required.

The NSR factors for each metal are shown in Table 14-3 and are calculated as follows:

$$\text{Gold NSR Factor} = (\$1400 - \$1.00) \times 0.86 \times 0.95 / 31.103 = \$36.748/\text{t}$$

$$\text{Silver NSR Factor} = (\$20 - \$1.50) \times 0.76 \times 0.95 / 31.103 = \$0.4294/\text{t}$$

$$\text{Lead NSR Factor} = (\$1.05 - \$0.194) \times 0.60 \times 0.95 \times 22.046 = \$10.753/\text{t}$$

$$\text{Zinc NSR Factor} = (\$1.20 - \$0.219) \times 0.64 \times 0.85 \times 22.046 = \$11.770/\text{t}$$

Table 14-4
Treatment Costs for Lead and Zinc Concentrates

Parameter	Units	Lead	Zinc
Concentrate Grade	(%)	60%	53%
Moisture Content	(%)	8.5%	8.5%
Concentrate Loss	(%)	0.0%	0.0%
Payable			
Percentage	(%)	95%	85%
Payable			
Lbs/Tonne	(lbs)	1,257	993
Treatment Cost Per DMT	(US\$)	217.00	190.00
Freight Per WMT	(US\$)	25.00	25.00
Treatment Cost Per Pound	(US\$)	0.173	0.191
Transport Cost Per Pound	(US\$)	0.022	0.027
Total Cost Per Pound	(US\$)	0.194	0.219

Total NSR is calculated by multiplying each factor times the mineral grade; the zinc and lead grades are assumed to be in percent (ppm/10000). The breakeven NSR cut-off is US\$15.36 per tonne; internal NSR cut-off is US\$13.71 per tonne. The Mineral Resources on Table 14-1 and Table 14-2 are based on internal NSR cut-off for all material types. There are no royalties applied to the mill material.

14.1.4 Additional Information

The Mineral Resources are classified in accordance with the Canadian Institute of Mining, Metallurgy and Petroleum (“CIM”) “CIM Definition Standards – For Mineral Resources and Mineral Reserves” adopted by the CIM Council (as amended, the “CIM Definition Standards”) in accordance with the requirements of NI 43-101. Mineral Reserve and Mineral Resource estimates reflect the reasonable expectation that all necessary permits and approvals will be obtained and maintained.

There is no guarantee that any of the Mineral Resources will be converted to Mineral Reserve. The Inferred Mineral Resources included in this Technical Report meet the current definition of Inferred Mineral Resources. The quantity and grade of Inferred Mineral Resources are uncertain in nature and there has been insufficient exploration to define these inferred Mineral Resources as an Indicated Mineral Resource. It is, however, expected that the majority of Inferred Mineral Resource could be upgraded to Indicated Mineral Resource with continued exploration.

IMC does not believe that there are significant risks to the Mineral Resource estimates based on environmental, permitting, legal, title, taxation, socio-economic, marketing, or political factors. The Project is in a jurisdiction friendly to mining. The most significant risks to the Mineral Resource are related to economic parameters such as prices lower than forecast, recoveries lower than forecast, or costs higher than the current estimates.

All the mineralization comprised in the Mineral Resource estimate with respect to the Project are contained on mineral titles controlled by Orla. However, the Mineral Resource estimate assumes that the north wall of the conceptual floating pit cone used to demonstrate reasonable prospects for eventual economic extraction extends onto lands where mineral title is held by Fresnillo, and that waste would be mined on Fresnillo’s mineral titles. The Layback Agreement allows Orla to expand the Camino Rojo oxide pit onto part of Fresnillo’s mineral concession located immediately north of Orla’s property. This expansion will increase oxide ore available for extraction on Orla’s property below the pit outlined in the 2019 Technical Report.

The Layback Agreement with Fresnillo is only with respect to the portion of the heap leach material included in the current Mineral Reserve. As such, any potential development of the Camino Rojo property that includes an open pit encompassing the entire Mineral Resource estimate is dependent on entering into an additional agreement with Fresnillo (or any potential subsequent

owner of the mineral titles). It is estimated that approximately two-thirds of the Mill Resource estimate and one quarter of the Leach Resource comprising the Mineral Resource estimate are dependent on an additional agreement being entered into with Fresnillo. The Leach Resource dependent on the additional agreement is mainly comprised of less oxidized transitional material with the lowest predicted heap-leach recoveries. The Mineral Resource estimate has been prepared based on the Qualified Person's reasoned judgment, in accordance with Canadian Institute of Mining, Metallurgy and Petroleum (CIM) Best Practices Guidelines and his professional standards of competence, that there is a reasonable expectation that all necessary permits, agreements and approvals will be obtained and maintained, including the additional agreement with Fresnillo to allow mining of waste material on its mineral concessions. In particular, when determining the prospects for eventual economic extraction, consideration was given to industry practice, and a timeframe of 10-15 years.

Delays in, or failure to obtain, an additional agreement with Fresnillo would affect the development of a significant portion of the Mineral Resources of the Camino Rojo property that are not included in the updated Feasibility Study mine plan, in particular by limiting access to significant mineralized material at depth. There can be no assurance that Orla will be able to negotiate such additional agreement on terms that are satisfactory to Orla and Fresnillo or that there will not be delays in obtaining the necessary additional agreement.

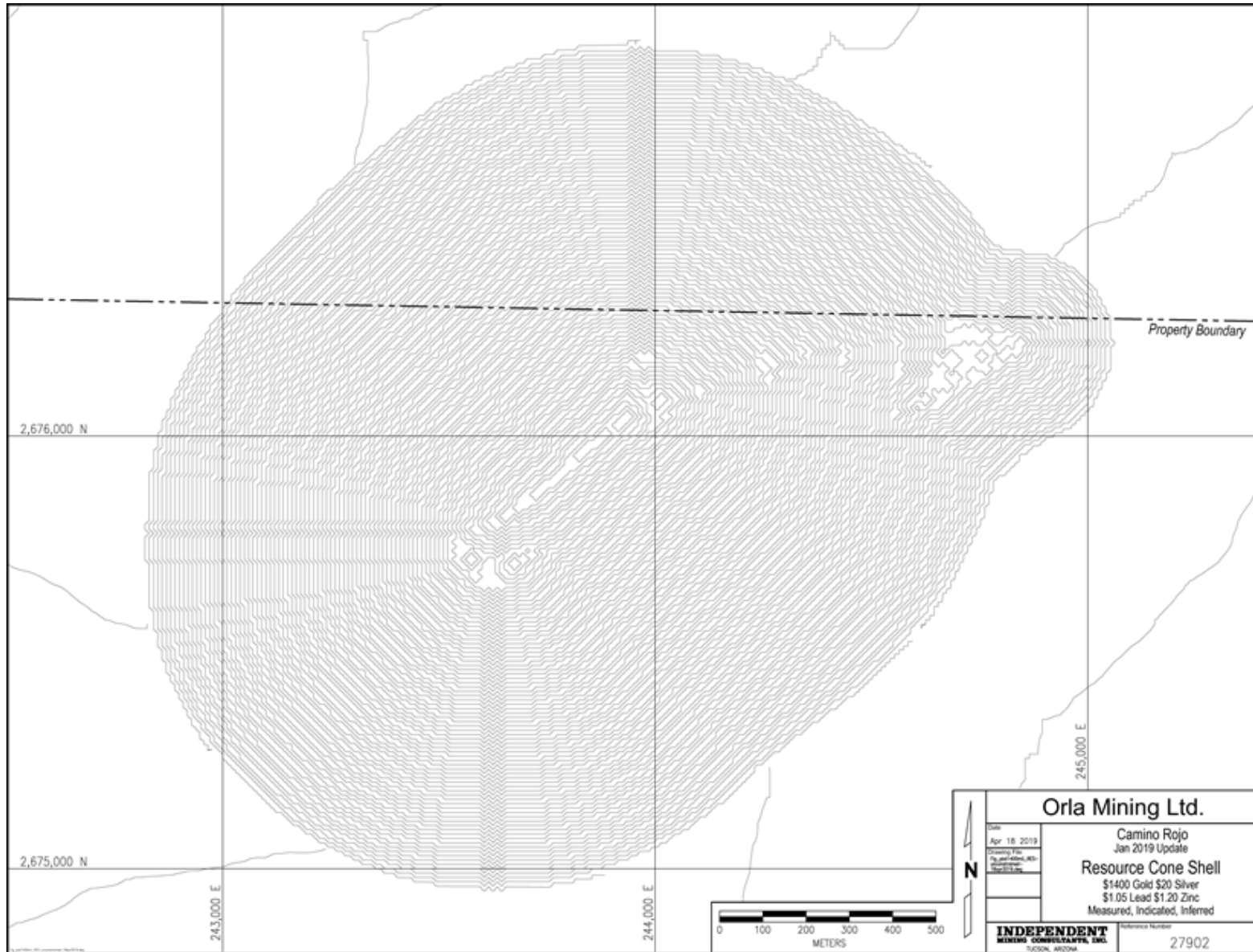

Figure 14.1 Mineral Resource Constraining Cone Shell, IMC 2019

14.2 Description of the Block Model

14.2.1 General

The Camino Rojo Mineral Resource is based on a block model developed by IMC during January and February 2019. The model is based on 10m by 10m by 10m high blocks. The model is not rotated. The main changes since the April 2018 model are:

- The Orla 2018 drilling data is incorporated into the model.
- The alteration and oxidation geological models have been updated.
- Portions of Canplats wet RC drilling has been designated as potentially contaminated and excluded from the model.

14.2.2 Geological Controls

Orla personnel developed various geological models as follows:

- A solid to define the post mineral lithologic unit and a surface to represent the contact between the Caracol and Indidura units.
- Solids to represent higher and lower amounts of potassium alteration in the Caracol and Indidura units; these were termed Potassium Pervasive (Kp) and Potassium Incipient (Ki) alteration zones.
- Solids to represent several levels of oxidation.
- A solid interpretation of a dike that runs through the deposit from southwest to northeast.

IMC reviewed these solids and incorporated them in the model. The lithology model, variable “lith”, is defined as follows:

**Table 14-5
Camino Rojo Model Rock Types (lith)**

Rock Code	Unit	Description
10	PM	Post Mineral
20	Car	Caracol
30	Ind	Indidura

The lithology code was assigned to the nearest whole block, i.e. the block was assigned if more than 50% of the block was inside the solid. Figure 14.2 shows the drillhole locations and the location of cross sections referenced in this section. Figure 14.3 shows the lithology on Section L112 along the long axis of the deposit (southwest to northeast). The Caracol unit is the main resource host.

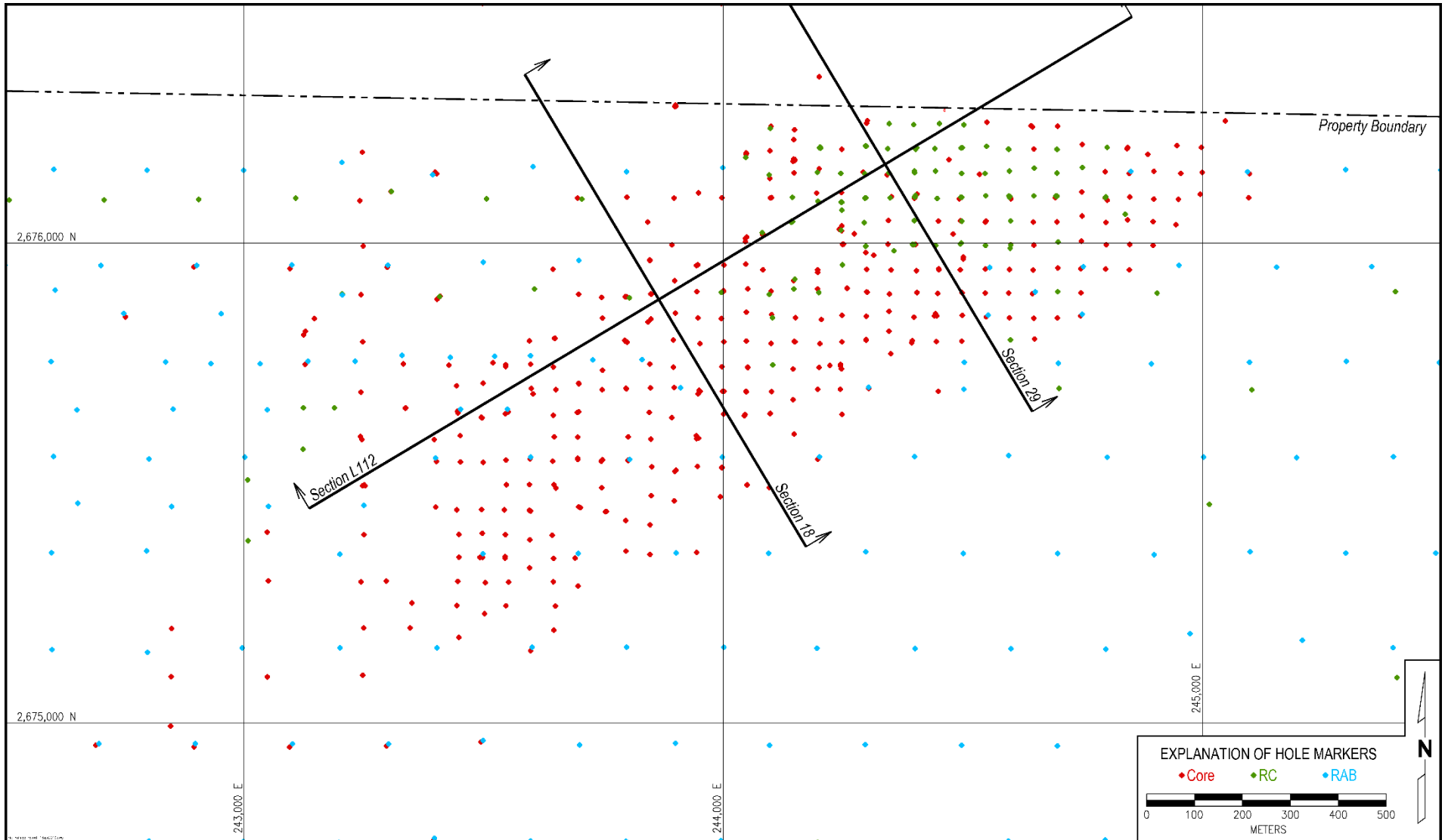

Figure 14.2 Hole and Cross Section Locations, IMC 2019

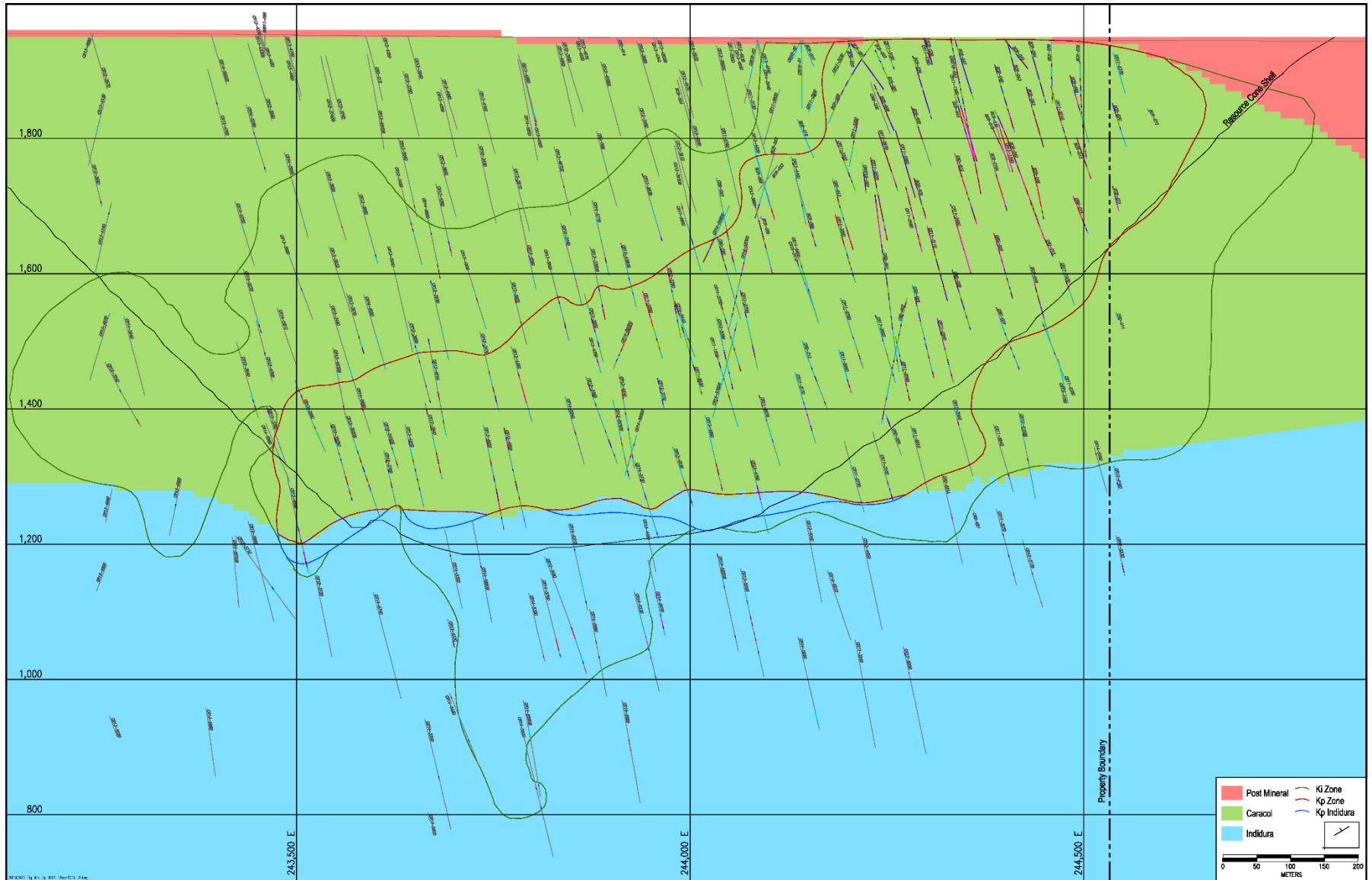

Figure 14.3 Lithology on Section L112, IMC 2019

The main control for grade estimation is based on the level of potassium alteration and is based on geological logging and ICP assays of potassium. The alteration model, variable “alt”, is defined as follows:

Table 14-6
Camino Rojo Alteration Types (alt)

Alteration Code	Alteration	Description
10	Kp	Potassium Pervasive – Caracol
20	Ki	Potassium Incipient – Caracol/Indidura
30	Ind	Potassium Pervasive - Indidura

The Kp (Potassium Pervasive) alteration tends to be pervasive potassium flooding and potassium content in ICP results are consistently above 3% throughout the zone. It is efficient in defining the area of higher gold assays. The Ki (Potassium Incipient) alteration has potassium flooding localized in bands associated with structures and potassium in ICP results are variable, with the altered portions having greater than 3% and the unaltered <1 to 3% potassium. Figure 14.4 through Figure 14.6 are sections of the alteration. Figure 14.4 is long Section L112. Figure 14.5 and Figure 14.6 are in the southwest and northeast portions of the deposit respectively.

The oxide model, variable “oxide” is defined as follows:

Table 14-7
Camino Rojo Oxide-Sulphide Model (oxide)

Oxide Code	Type	Description
10	Ox	Oxide
20	TrH	Transition 60-90% Oxide
30	TrL	Transition 30-60% Oxide
40	TrS	Transition 10-30% Oxide
50	Slf	Sulphide

The solids were developed based on % oxide in the drillhole database as logged by Goldcorp. Orla geologists logged holes on several sections to verify the Goldcorp loggings. Figure 14.7 shows a cross section of the oxide model in the northeast portion of the deposit. The southwest portion of the deposit is mostly sulphide.

In addition to the above geologic controls, IMC also included a domain code in the model. This was due to perceived differences in the orientation of the mineralization in the higher elevation

northeast portion of the Caracol versus the deeper southwest portion. These are described in Table 14-8. Figure 14.8 shows a long section of the domains.

Table 14-8
Camino Rojo Estimation Domains (domain)

Domain Code	Domain	Description
10	NEKp	Kp in the NE
15	NEKi	Ki in the NE
20	SWKp	Kp in the SW
25	SWKi	Ki in the SW
30	INKp	Kp in Indidura
35	INKi	Ki in Indidura

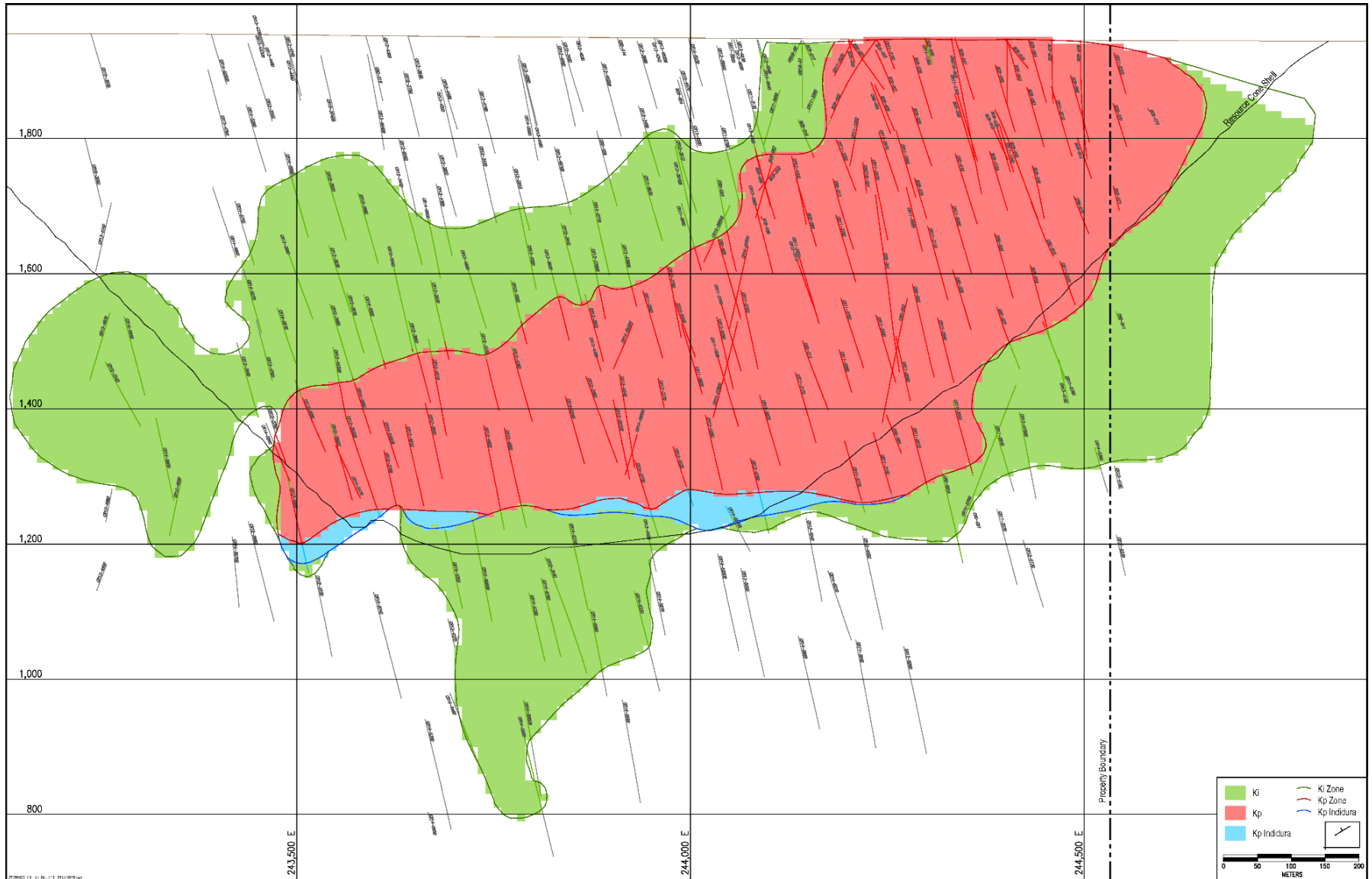

Figure 14.4 Alteration on Section L112, IMC 2019

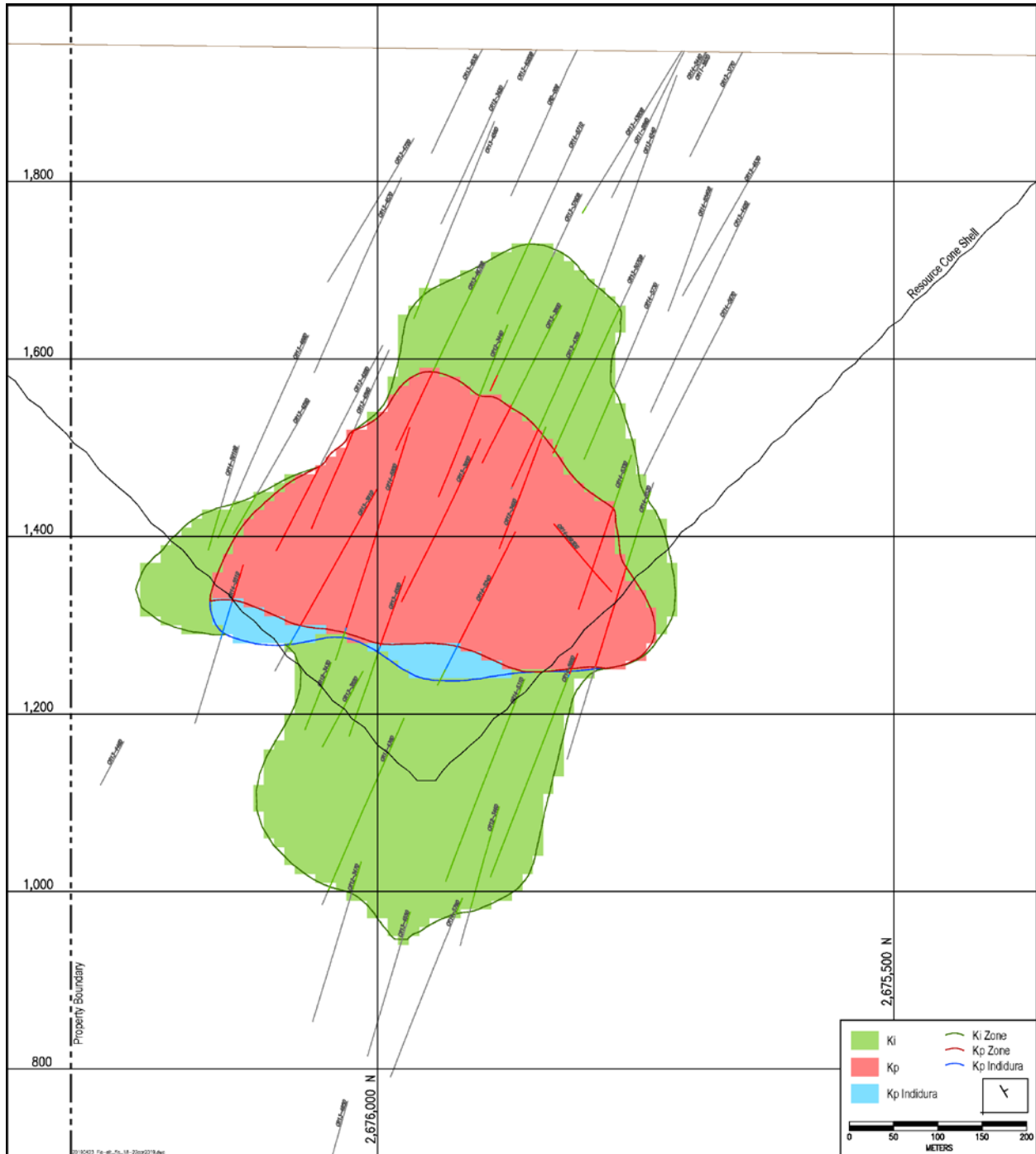

Figure 14.5 Alteration on Section 18, IMC 2019

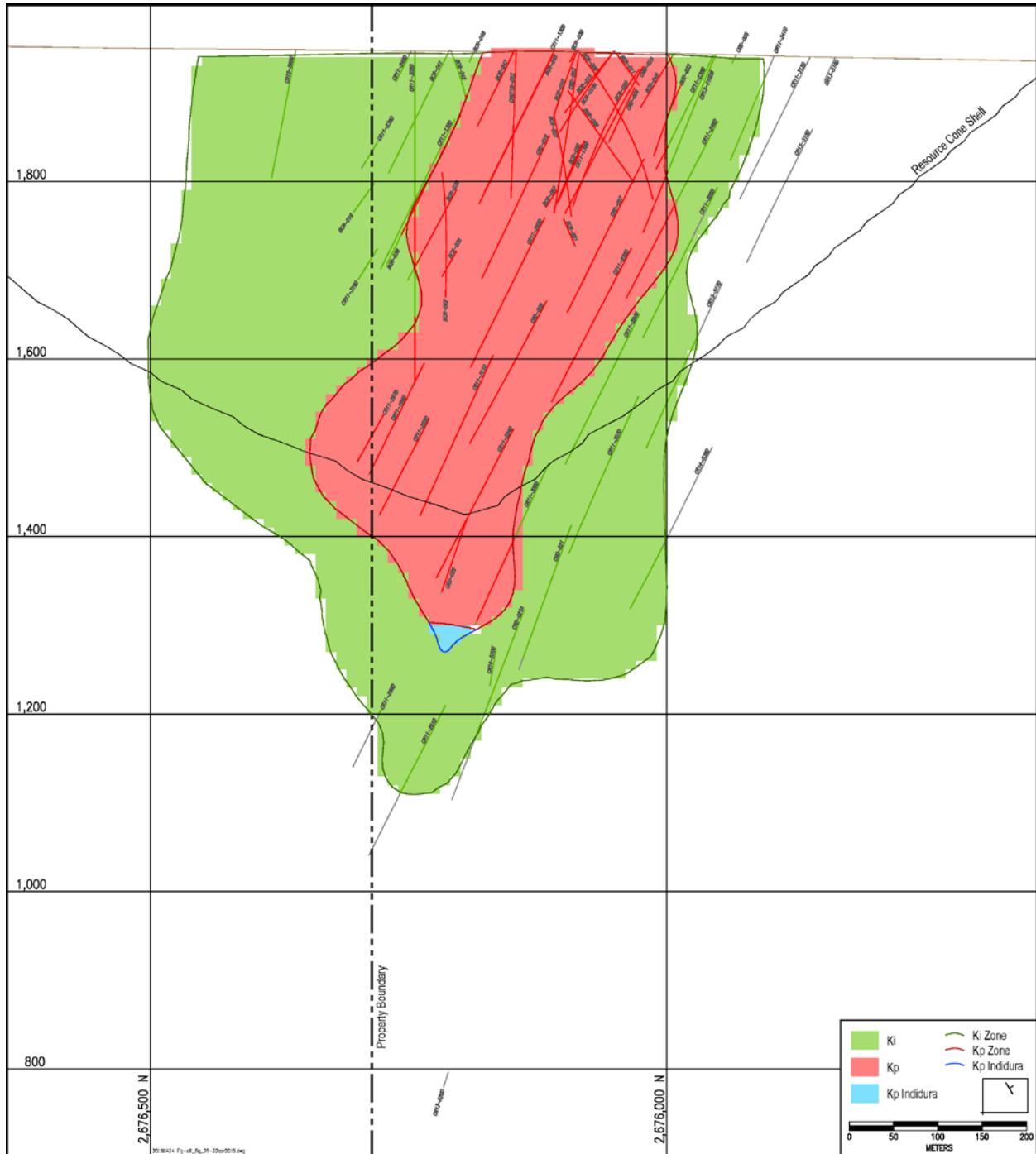

Figure 14.6 Alteration on Section 29, IMC 2019

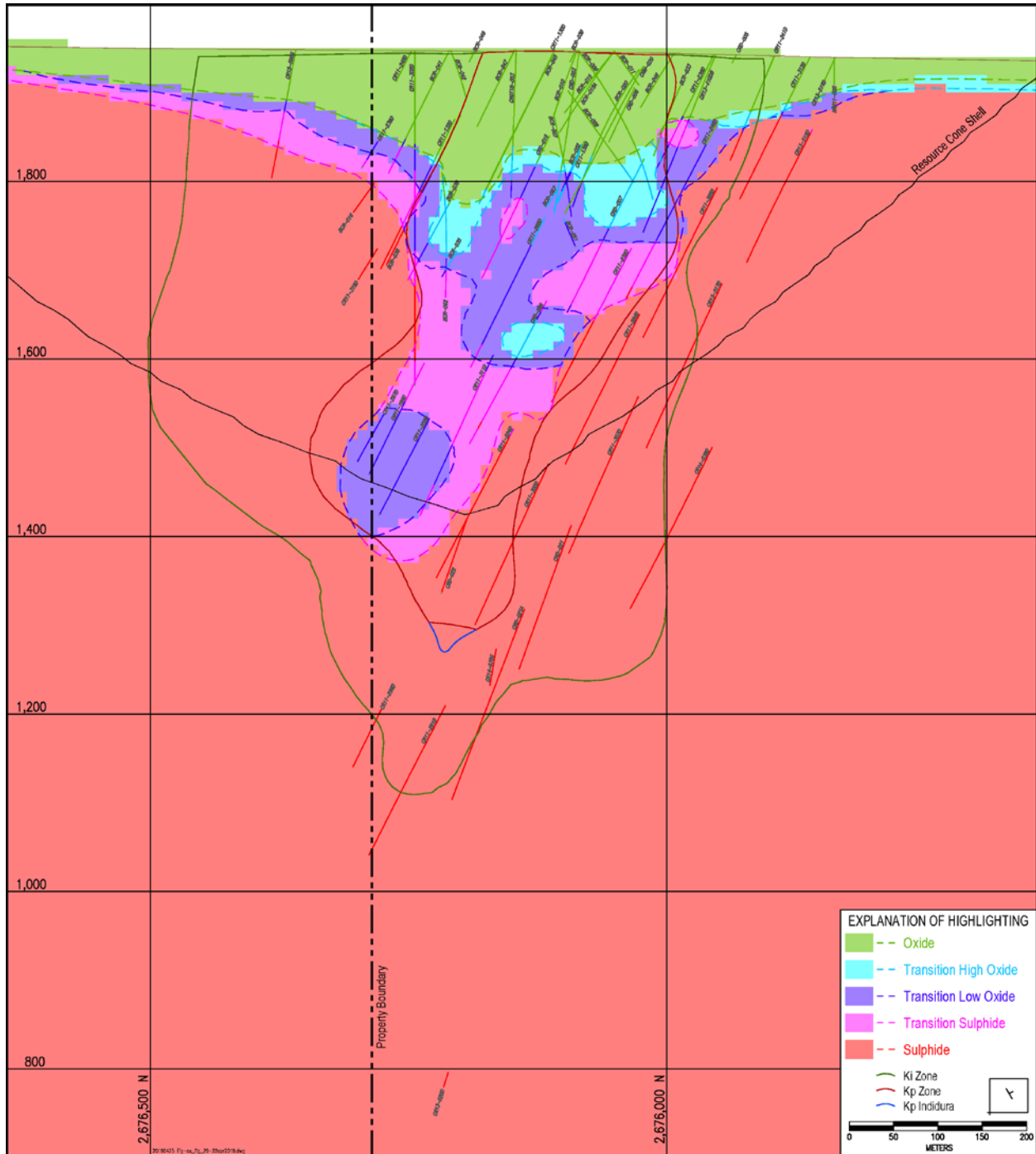

Figure 14.7 Oxidation Zones on Section 29, IMC 2019

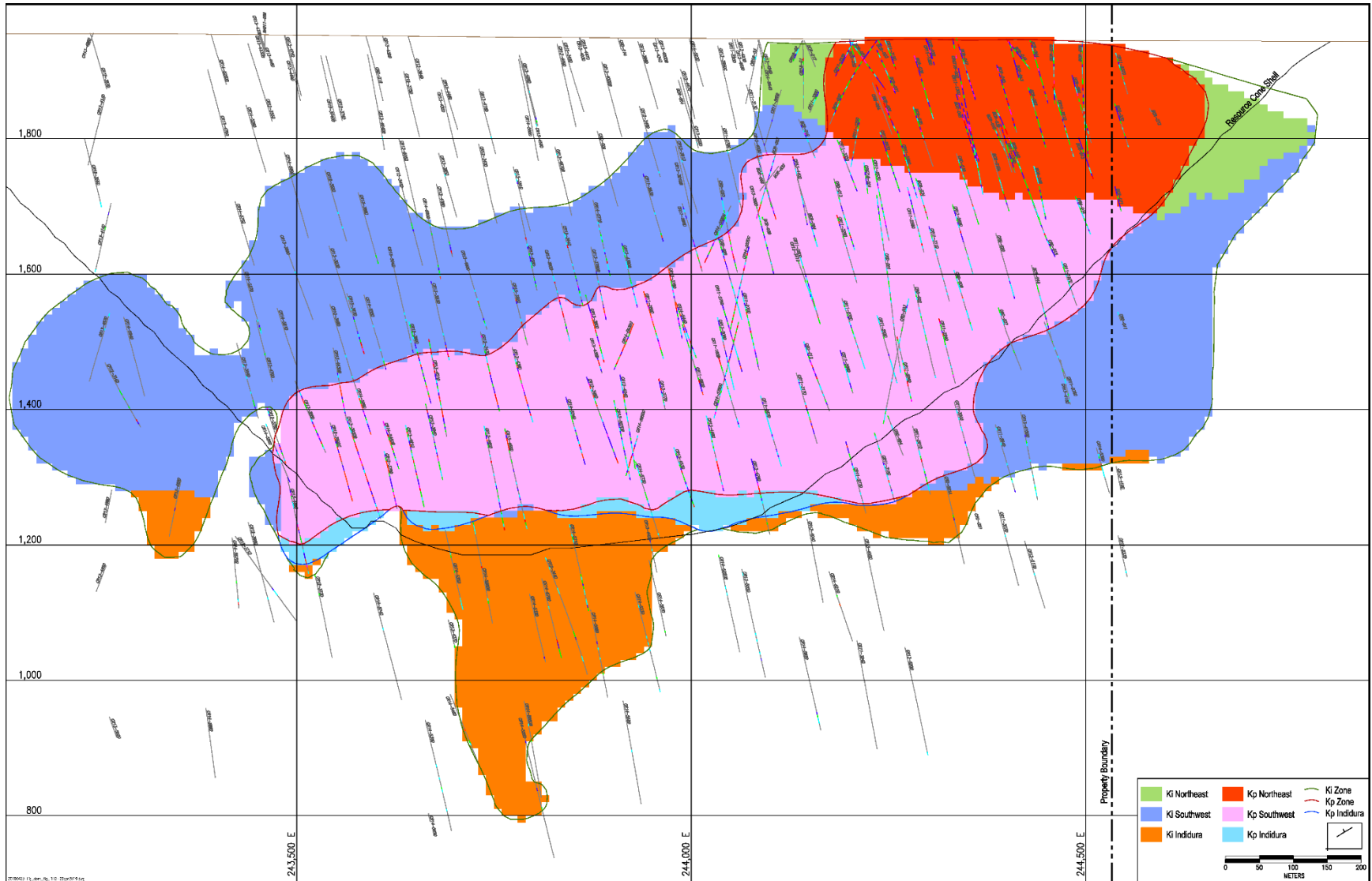

Figure 14.8 Estimation Domains on Section L112, IMC 2019

14.2.3 Potentially Contaminated RC Samples

As discussed in Section 12.0, IMC conducted a review of the Canplats RC drilling results, particularly portions of the holes that were deemed wet. Based on the analysis IMC determined that the assay intervals marked as wet or humid for the following 16 holes are potentially contaminated and they were not used for resource modeling:

BCR-031	BCR-039	BCR-040	BCR-052
BCR-069	BCR-080	BCR-010	BCR-028
BCR-030	BCR-032	BCR-035	BCR-044
BCR-057	BCR-074	BCR-084	BCR-085

14.2.4 Cap Grades and Compositing

IMC reviewed the distribution of assays for gold, silver, lead, and zinc, by six different populations and applied cap grades as shown in Figure 14.9. The top part of the table shows the cap grades and the bottom shows the number of assays capped. The cap grades were generally derived by reviewing probability plots and sorted lists of the assays to find breaks in the distributions. The cap grades are at the 99.8 percentile of the distributions for gold and silver and at the 99.9 percentile for zinc and lead; they would not generally be considered very aggressive capping.

**Table 14-9
Cap Grades and Number of Assays Capped**

Metal	Units	Northeast		Southwest		Indidura	
		Kp	Ki	Kp	Ki	Kp	Ki
Gold	(g/t)	11	5.4	27	6.8	18.5	15
Silver	(g/t)	108	79	145	263	103	73
Lead	(%)	1.9	1.4	2.7	2.2	1.0	0.75
Zinc	(%)	3.1	2.4	4.7	3.2	5.2	7.5
Number of Assays Capped							
Metal	Units	Northeast		Southwest		Indidura	
		Kp	Ki	Kp	Ki	Kp	Ki
Gold	(none)	27	18	59	63	4	18
Silver	(none)	28	18	61	62	4	18
Lead	(none)	17	10	31	33	2	9
Zinc	(none)	15	10	31	29	2	9

Figure 14.9 and Figure 14.10 show probability plots of gold assays and gold composites respectively for the NE domain. The plots show original and capped values for the Kp and Ki alteration types. Figure 14.11 and Figure 14.12 show the probability plots for gold for the SW domain and Figure 14.13 and Figure 14.14 are for Indidura.

The lithology and alteration codes were assigned to the drillhole database by back-assignment from the solids. The domain codes were assigned to the database by back-assignment from the model.

The drillhole database was composited to regular 5m downhole composites, though the current model is based on 10m blocks. This was to avoid blurring the rock type and alteration contacts. Table 14-10 and Table 14-11 show basic descriptive statistics for the assays and 5m composites respectively. Results are shown for gold, silver, lead, and zinc and are by the various estimation domain populations. The left side of the table shows results for uncapped values and the right side shows capped values.

**Table 14-10
Summary Statistics of Assays**

Metal/Domain	Not Capped					Capped				
	No. of Samples	Mean (g/t)	Std Dev (g/t)	Max (g/t)	Min (g/t)	No. of Samples	Mean (g/t)	Std Dev (g/t)	Max (g/t)	Min (g/t)
Gold:	92,564	0.56	2.18	290.0	0.002	92,564	0.54	1.51	27.0	0.002
Northeast Domain:	21,784	0.57	1.12	51.3	0.002	21,784	0.56	0.91	11.0	0.002
Kp Alteration	12,934	0.79	1.31	51.3	0.002	12,934	0.77	1.05	11.0	0.002
Ki Alteration	8,850	0.25	0.61	22.3	0.002	8,850	0.24	0.50	5.4	0.002
Southwest Domain:	60,483	0.58	2.50	290.0	0.002	60,483	0.55	1.71	27.0	0.002
Kp Alteration	29,691	1.01	3.42	290.0	0.002	29,691	0.96	2.30	27.0	0.002
Ki Alteration	30,792	0.17	0.81	48.0	0.002	30,792	0.16	0.56	6.8	0.002
All Caracol	82,267	0.58	2.22	290.0	0.002	82,267	0.56	1.54	27.0	0.002
Kp Alteration	42,625	0.94	2.95	290.0	0.002	42,625	0.90	2.01	27.0	0.002
Ki Alteration	39,642	0.19	0.77	48.0	0.002	39,642	0.18	0.54	6.8	0.002
Indidura	10,297	0.42	1.81	63.8	0.002	10,297	0.38	1.20	18.5	0.002
Kp Alteration	1,652	0.80	1.81	27.1	0.002	1,652	0.79	1.68	18.5	0.002
Ki Alteration	8,645	0.34	1.80	63.8	0.002	8,645	0.31	1.07	15.0	0.002
Metal/Domain	No. of Samples	Mean (g/t)	Std Dev (g/t)	Max (g/t)	Min (g/t)	No. of Samples	Mean (g/t)	Std Dev (g/t)	Max (g/t)	Min (g/t)
Silver:	92,564	6.8	24.8	4870	0.14	92,564	6.5	14.6	263	0.14
Northeast Domain:	21,784	11.7	35.9	4870	0.25	21,784	11.3	12.7	108	0.25
Kp Alteration	12,934	15.5	45.5	4870	0.25	12,934	15.0	13.9	108	0.25
Ki Alteration	8,850	6.0	9.2	338	0.25	8,850	5.9	8.1	79	0.25
Southwest Domain:	60,483	5.6	21.2	1310	0.14	60,483	5.4	15.7	263	0.14
Kp Alteration	29,691	6.8	15.9	804	0.25	29,691	6.7	13.2	145	0.25
Ki Alteration	30,792	4.4	25.2	1310	0.14	30,792	4.1	17.8	263	0.14
All Caracol	82,267	7.2	26.0	4870	0.14	82,267	6.9	15.2	263	0.14
Kp Alteration	42,625	9.5	28.6	4870	0.25	42,625	9.2	14.0	145	0.25
Ki Alteration	39,642	4.8	22.6	1310	0.14	39,642	4.5	16.1	263	0.14
Indidura	10,297	3.3	10.5	421	0.25	10,297	3.2	7.9	103	0.25
Kp Alteration	1,652	6.4	15.4	421	0.25	1,652	6.2	11.5	103	0.25
Ki Alteration	8,645	2.8	9.1	290	0.25	8,645	2.6	6.8	73	0.25
Metal/Domain	No. of Samples	Mean (%)	Std Dev (%)	Max (%)	Min (%)	No. of Samples	Mean (%)	Std Dev (%)	Max (%)	Min (%)
Lead:	92,564	0.080	0.213	12.85	0.00	92,564	0.079	0.186	2.70	0.00
Northeast Domain:	21,784	0.195	0.237	8.85	0.00	21,784	0.194	0.226	1.90	0.00
Kp Alteration	12,934	0.265	0.245	3.53	0.00	12,934	0.264	0.242	1.90	0.00
Ki Alteration	8,850	0.092	0.180	8.85	0.00	8,850	0.091	0.149	1.40	0.00
Southwest Domain:	60,483	0.051	0.206	12.85	0.00	60,483	0.049	0.167	2.70	0.00
Kp Alteration	29,691	0.069	0.234	12.85	0.00	29,691	0.067	0.189	2.70	0.00
Ki Alteration	30,792	0.034	0.173	7.90	0.00	30,792	0.032	0.139	2.20	0.00
All Caracol	82,267	0.089	0.224	12.85	0.00	82,267	0.087	0.195	2.70	0.00
Kp Alteration	42,625	0.128	0.254	12.85	0.00	42,625	0.127	0.226	2.70	0.00
Ki Alteration	39,642	0.047	0.176	8.85	0.00	39,642	0.045	0.144	2.20	0.00
Indidura	10,297	0.011	0.061	2.69	0.00	10,297	0.010	0.046	1.00	0.00
Kp Alteration	1,652	0.022	0.091	2.69	0.00	1,652	0.021	0.066	1.00	0.00
Ki Alteration	8,645	0.008	0.054	2.09	0.00	8,645	0.008	0.040	0.75	0.00
Metal/Domain	No. of Samples	Mean (%)	Std Dev (%)	Max (%)	Min (%)	No. of Samples	Mean (%)	Std Dev (%)	Max (%)	Min (%)
Zinc:	92,562	0.204	0.400	13.00	0.00	92,562	0.202	0.384	7.50	0.00
Northeast Domain:	21,784	0.330	0.319	5.44	0.00	21,784	0.329	0.312	3.10	0.00
Kp Alteration	12,934	0.431	0.341	4.41	0.00	12,934	0.431	0.337	3.10	0.00
Ki Alteration	8,850	0.181	0.209	5.44	0.00	8,850	0.180	0.191	2.40	0.00
Southwest Domain:	60,482	0.161	0.372	13.00	0.00	60,482	0.160	0.353	4.70	0.00
Kp Alteration	29,690	0.254	0.453	13.00	0.00	29,690	0.253	0.432	4.70	0.00
Ki Alteration	30,792	0.071	0.239	7.81	0.00	30,792	0.070	0.219	3.20	0.00
All Caracol	82,266	0.206	0.366	13.00	0.00	82,266	0.205	0.351	4.70	0.00
Kp Alteration	42,624	0.308	0.430	13.00	0.00	42,624	0.307	0.414	4.70	0.00
Ki Alteration	39,642	0.095	0.237	7.81	0.00	39,642	0.094	0.218	3.20	0.00
Indidura	10,296	0.187	0.607	13.00	0.00	10,296	0.185	0.586	7.50	0.00
Kp Alteration	1,652	0.291	0.567	6.21	0.00	1,652	0.290	0.559	5.20	0.00
Ki Alteration	8,644	0.167	0.612	13.00	0.00	8,644	0.165	0.589	7.50	0.00

**Table 14-11
Summary Statistics of 5m Composites**

Metal/Domain	Not Capped					Capped				
	No. of Samples	Mean (g/t)	Std Dev (g/t)	Max (g/t)	Min (g/t)	No. of Samples	Mean (g/t)	Std Dev (g/t)	Max (g/t)	Min (g/t)
Gold:	28,761	0.56	1.37	89.1	0.002	28,761	0.54	1.02	24.2	0.002
Northeast Domain:	7,142	0.57	0.81	22.3	0.002	7,142	0.56	0.69	8.0	0.002
Kp Alteration	4,282	0.79	0.93	22.3	0.002	4,282	0.77	0.77	8.0	0.002
Ki Alteration	2,860	0.26	0.42	7.0	0.002	2,860	0.25	0.38	4.0	0.002
Southwest Domain:	18,524	0.58	1.57	89.1	0.002	18,524	0.55	1.15	24.2	0.002
Kp Alteration	9,138	1.00	2.09	89.1	0.002	9,138	0.95	1.49	24.2	0.002
Ki Alteration	9,386	0.17	0.53	19.7	0.002	9,386	0.16	0.38	6.0	0.002
All Caracol	25,666	0.58	1.40	89.1	0.002	25,666	0.55	1.04	24.2	0.002
Kp Alteration	13,420	0.93	1.80	89.1	0.002	13,420	0.89	1.31	24.2	0.002
Ki Alteration	12,246	0.19	0.51	19.7	0.002	12,246	0.18	0.38	6.0	0.002
Indidura	3,095	0.42	1.09	21.6	0.002	3,095	0.39	0.77	7.9	0.002
Kp Alteration	500	0.80	1.11	9.7	0.004	500	0.79	1.04	7.9	0.004
Ki Alteration	2,595	0.35	1.07	21.6	0.002	2,595	0.31	0.68	7.8	0.002
Metal/Domain	No. of Samples	Mean (g/t)	Std Dev (g/t)	Max (g/t)	Min (g/t)	No. of Samples	Mean (g/t)	Std Dev (g/t)	Max (g/t)	Min (g/t)
Silver:	28,761	6.9	17.2	1961	0.25	28,761	6.6	10.4	211	0.25
Northeast Domain:	7,142	11.8	25.5	1961	0.25	7,142	11.4	10.2	89	0.25
Kp Alteration	4,282	15.6	31.9	1961	0.25	4,282	15.0	10.8	89	0.25
Ki Alteration	2,860	6.1	6.5	115	0.25	2,860	6.0	6.1	58	0.25
Southwest Domain:	18,524	5.6	13.7	531	0.25	18,524	5.3	10.5	211	0.25
Kp Alteration	9,138	6.8	10.4	252	0.25	9,138	6.7	9.0	128	0.25
Ki Alteration	9,386	4.4	16.3	531	0.25	9,386	4.1	11.7	211	0.25
All Caracol	25,666	7.3	18.0	1961	0.25	25,666	7.0	10.8	211	0.25
Kp Alteration	13,420	9.6	20.4	1961	0.25	13,420	9.3	10.4	128	0.25
Ki Alteration	12,246	4.8	14.6	531	0.25	12,246	4.5	10.7	211	0.25
Indidura	3,095	3.4	7.3	181	0.25	3,095	3.2	5.6	85	0.25
Kp Alteration	500	6.4	10.3	140	0.25	500	6.2	8.3	85	0.25
Ki Alteration	2,595	2.8	6.4	181	0.25	2,595	2.7	4.8	59	0.25
Metal/Domain	No. of Samples	Mean (%)	Std Dev (%)	Max (%)	Min (%)	No. of Samples	Mean (%)	Std Dev (%)	Max (%)	Min (%)
Lead:	28,761	0.083	0.159	4.61	0.00	28,761	0.081	0.147	1.92	0.00
Northeast Domain:	7,142	0.196	0.193	2.99	0.00	7,142	0.195	0.189	1.43	0.00
Kp Alteration	4,282	0.263	0.201	1.56	0.00	4,282	0.263	0.199	1.43	0.00
Ki Alteration	2,860	0.094	0.126	2.99	0.00	2,860	0.093	0.112	0.93	0.00
Southwest Domain:	18,524	0.051	0.133	4.61	0.00	18,524	0.049	0.112	1.92	0.00
Kp Alteration	9,138	0.069	0.151	4.61	0.00	9,138	0.067	0.129	1.92	0.00
Ki Alteration	9,386	0.034	0.110	3.62	0.00	9,386	0.032	0.090	1.46	0.00
All Caracol	25,666	0.091	0.166	4.61	0.00	25,666	0.090	0.153	1.92	0.00
Kp Alteration	13,420	0.131	0.192	4.61	0.00	13,420	0.129	0.180	1.92	0.00
Ki Alteration	12,246	0.048	0.117	3.62	0.00	12,246	0.046	0.099	1.46	0.00
Indidura	3,095	0.011	0.041	1.01	0.00	3,095	0.010	0.032	0.63	0.00
Kp Alteration	500	0.023	0.068	1.01	0.00	500	0.021	0.050	0.51	0.00
Ki Alteration	2,595	0.008	0.033	0.77	0.00	2,595	0.008	0.026	0.63	0.00
Metal/Domain	No. of Samples	Mean (%)	Std Dev (%)	Max (%)	Min (%)	No. of Samples	Mean (%)	Std Dev (%)	Max (%)	Min (%)
Zinc:	28,761	0.207	0.289	5.58	0.00	28,761	0.206	0.281	5.24	0.00
Northeast Domain:	7,142	0.332	0.267	3.23	0.01	7,142	0.331	0.263	2.96	0.01
Kp Alteration	4,282	0.432	0.277	3.23	0.01	4,282	0.431	0.275	2.96	0.01
Ki Alteration	2,860	0.183	0.161	2.95	0.01	2,860	0.182	0.149	1.48	0.01
Southwest Domain:	18,524	0.161	0.258	3.96	0.00	18,524	0.160	0.249	3.25	0.00
Kp Alteration	9,138	0.254	0.305	3.96	0.00	9,138	0.253	0.296	3.25	0.00
Ki Alteration	9,386	0.071	0.155	2.55	0.00	9,386	0.070	0.144	2.14	0.00
All Caracol	25,666	0.209	0.271	3.96	0.00	25,666	0.208	0.264	3.25	0.00
Kp Alteration	13,420	0.311	0.308	3.96	0.00	13,420	0.310	0.301	3.25	0.00
Ki Alteration	12,246	0.097	0.163	2.95	0.00	12,246	0.096	0.153	2.14	0.00
Indidura	3,095	0.188	0.404	5.58	0.00	3,095	0.186	0.389	5.24	0.00
Kp Alteration	500	0.291	0.369	3.62	0.00	500	0.290	0.362	3.20	0.00
Ki Alteration	2,595	0.168	0.407	5.58	0.00	2,595	0.166	0.391	5.24	0.00

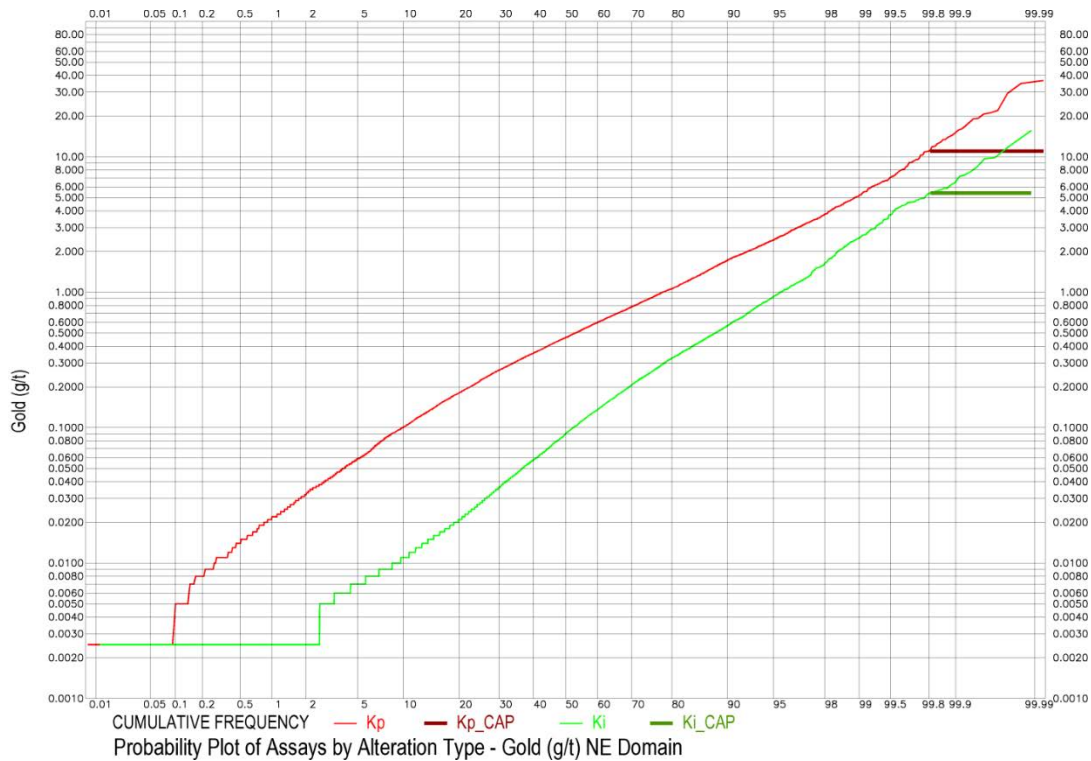

Figure 14.9 Probability Plot of Gold Assays by Alteration Type – NE Domain

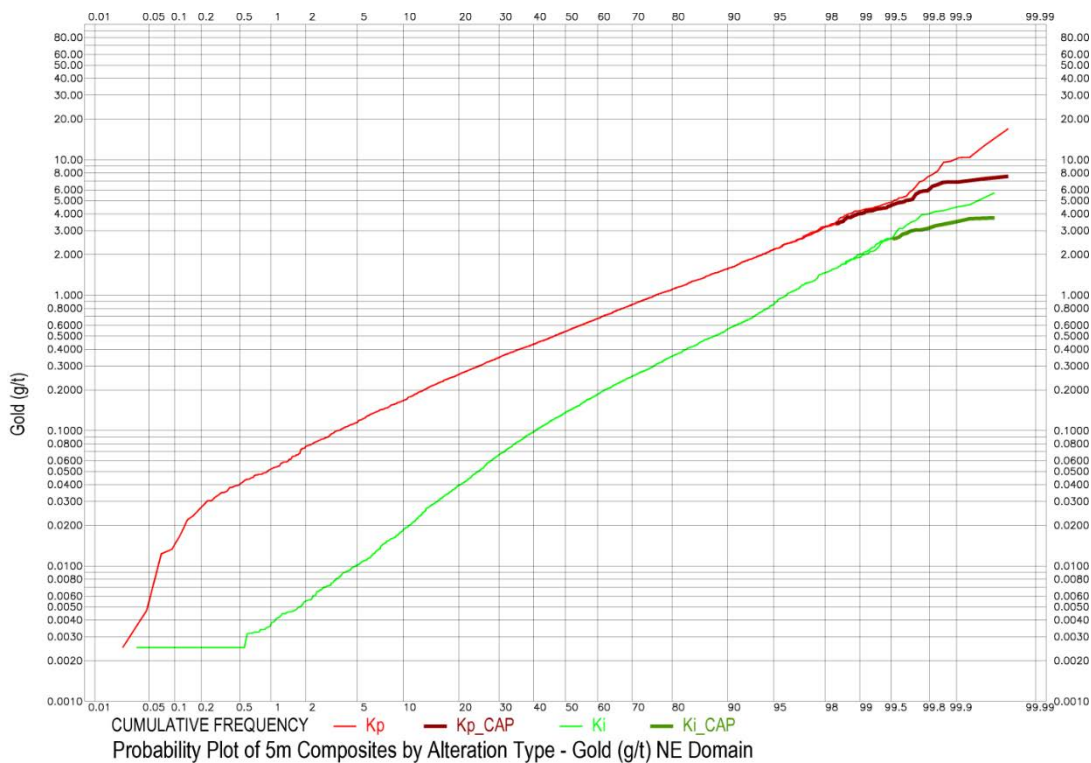

Figure 14.10 Probability Plot of Gold 5m Composites by Alteration Type – NE Domain

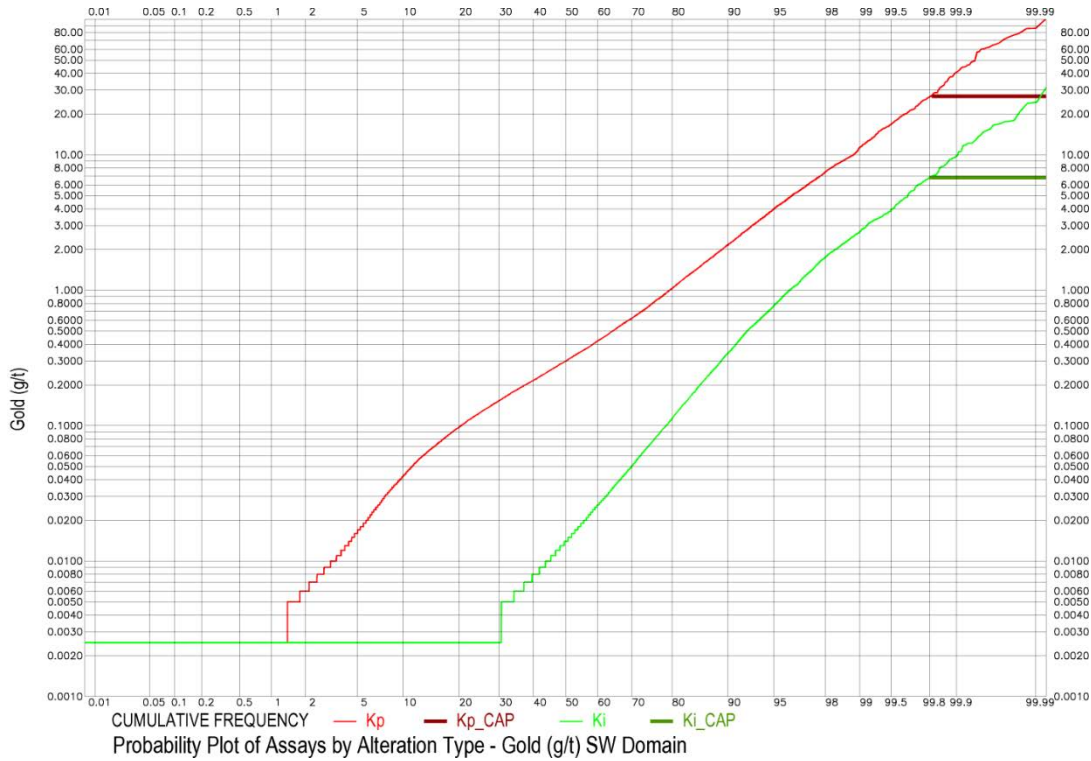

Figure 14.11 Probability Plot of Gold Assays by Alteration Type – SW Domain

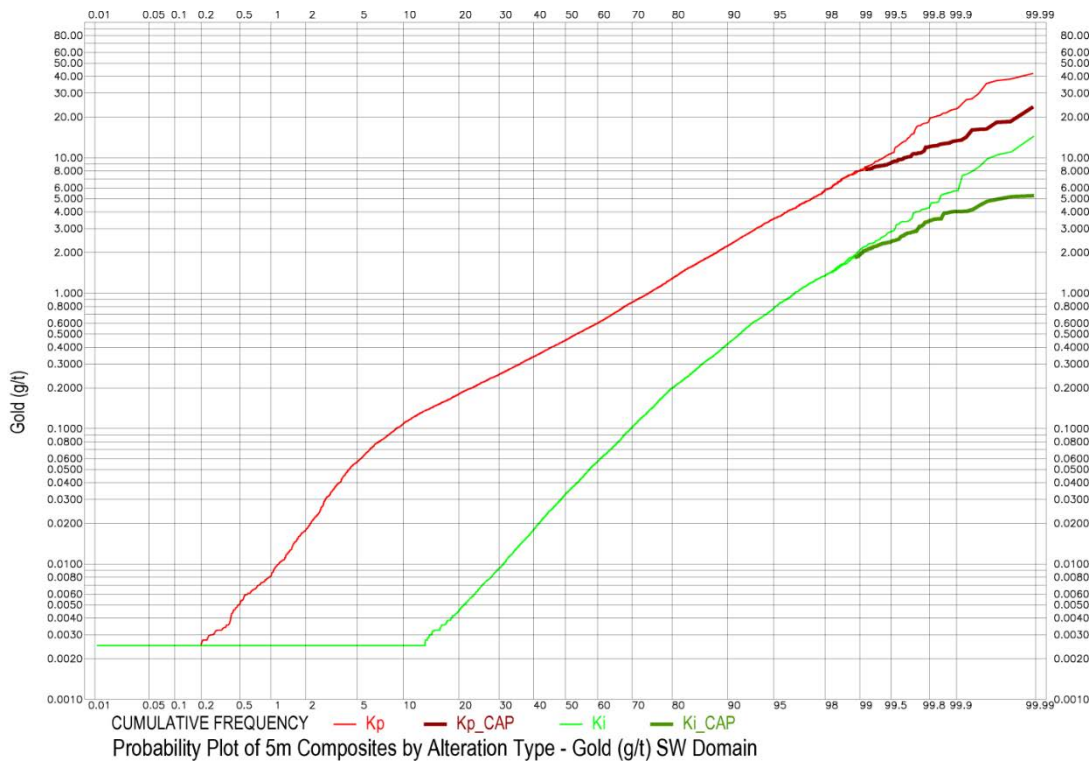

Figure 14.12 Probability Plot of Gold 5m Composites by Alteration Type – SW Domain

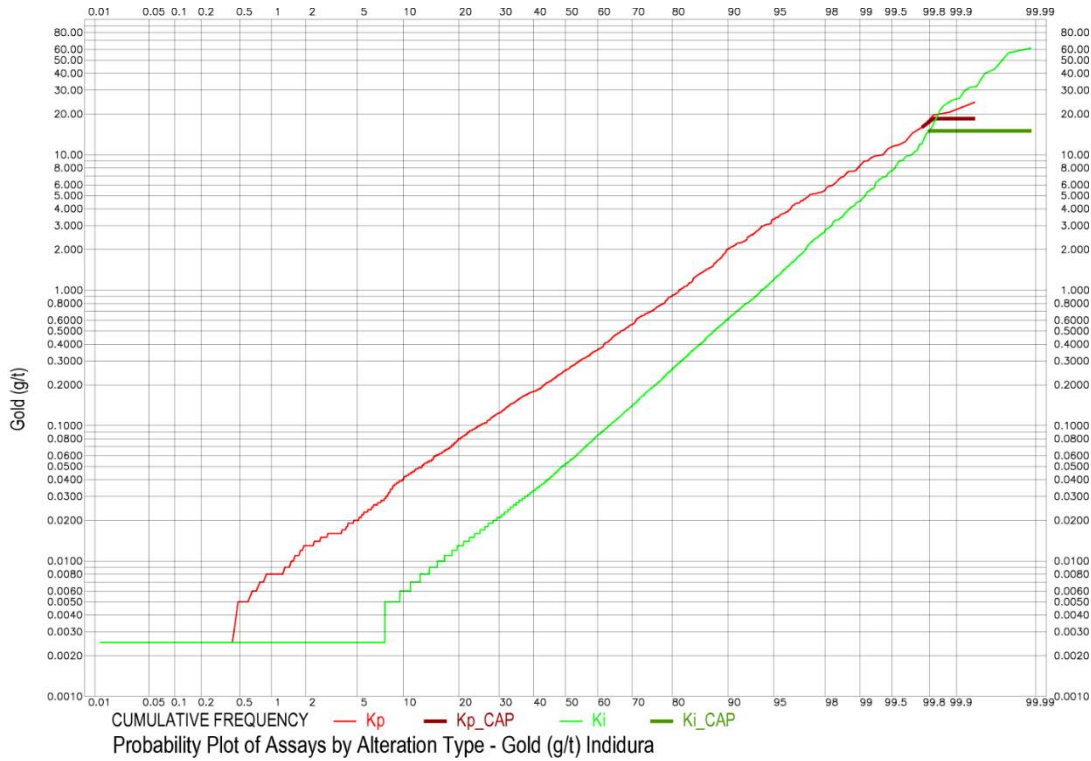

Figure 14.13 Probability Plot of Gold Assays by Alteration Type – Indidura

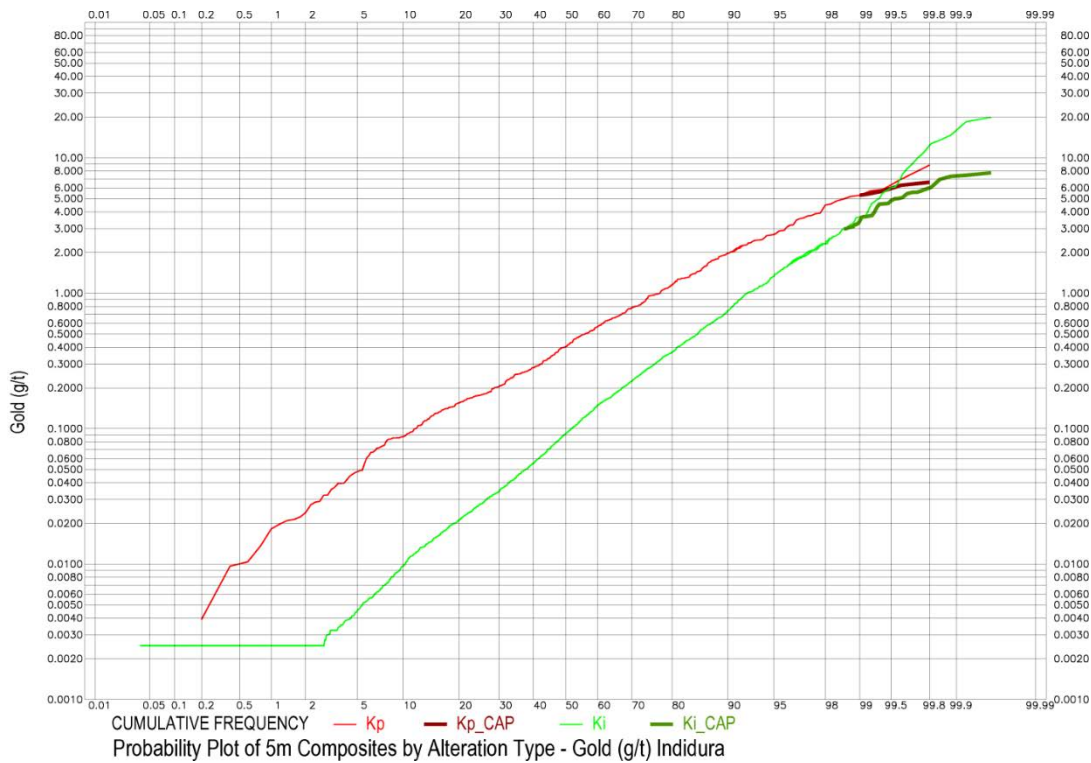

Figure 14.14 Probability Plot of Gold 5m Composites by Alteration Type – Indidura

14.2.5 Variograms

14.2.5.1 Northeast Domain

IMC conducted a variogram analysis of gold in the Kp alteration type for the NE domain. The analysis was based on the 5m composites. Figure 14.15 shows the variogram in the N60°E direction with no dip. This is a good variogram in terms of clarity and has a range of about 135m. This direction is assumed as the major axis for the variogram model. Figure 14.16 shows the variogram in the S30°E direction with a dip of 15°. This is also a good variogram in terms of clarity with ranges of 85 and 160m for the two structures fit to it. It is noted that the primary and secondary directions conform to the strike and dip of the bedding.

Figure 14.17 shows the variogram in the north direction with a 60° dip. This is approximately, but not exactly, the tertiary direction to the previous variograms. This direction represents the approximate downhole direction for much of the drilling, so is a convenient direction for calculation. The variogram is of good clarity, but relatively short range. The range of the first structure fit to the variogram is about 32m and about 90% of the total variability in this variogram takes place within about this distance.

14.2.5.2 Southwest Domain

Figure 14.18 shows the variogram in the S60°W direction with a 25° dip for the SW domain. This is assumed to be the primary axis, and it appears evident on cross sections. The variogram has good clarity with a range of about 100m.

Figure 14.19 shows the variogram in the north direction with a 60° dip. As previously mentioned, this is the approximate downhole direction for much of the drilling. Orla geological personnel propose that a primary control of mineralization is related to structures trending about N60°E with a steep NNW dip. This variogram is approximately in that direction. It can be seen however that the range of the variogram is quite short, about 8m for the first structure and 31m for the second structure. However, IMC could not find any direction perpendicular to the major axis that produced good variogram results. Based on this, it was determined to assume the secondary and tertiary directions were the same, and about half the range of the primary direction.

IMC did not run variograms for Indidura; there is not sufficient drilling. Indidura grade estimations are the same as for the SW domain. IMC also did not run variograms for the lower grade Ki alteration zones. The Ki searches are assumed to be the same as for Kp alteration.

Gold Northeast Domain - KP Alteration
 GAMMA (H) VARIOGRAM OF: cap_au
 N 60.0 E - NO DIP

Gamma (h)
 * variogram analysis of : cap_au
 data transformation : none
 lag option : 1 class size 15.
 file/variogram number : gamm_KP_NE_gold_P.av 1

azimuth 60.0 direction N 60.0 E
 dip angle 0.0 mean 0.7830
 horizontal window 15.0 variance 0.6100
 vertical window 15.0 no. of samples 4453

spherical: c 0.2633E+00 range 0.1345E+03
 nugget 0.3467E+00 sill 0.6100E+00

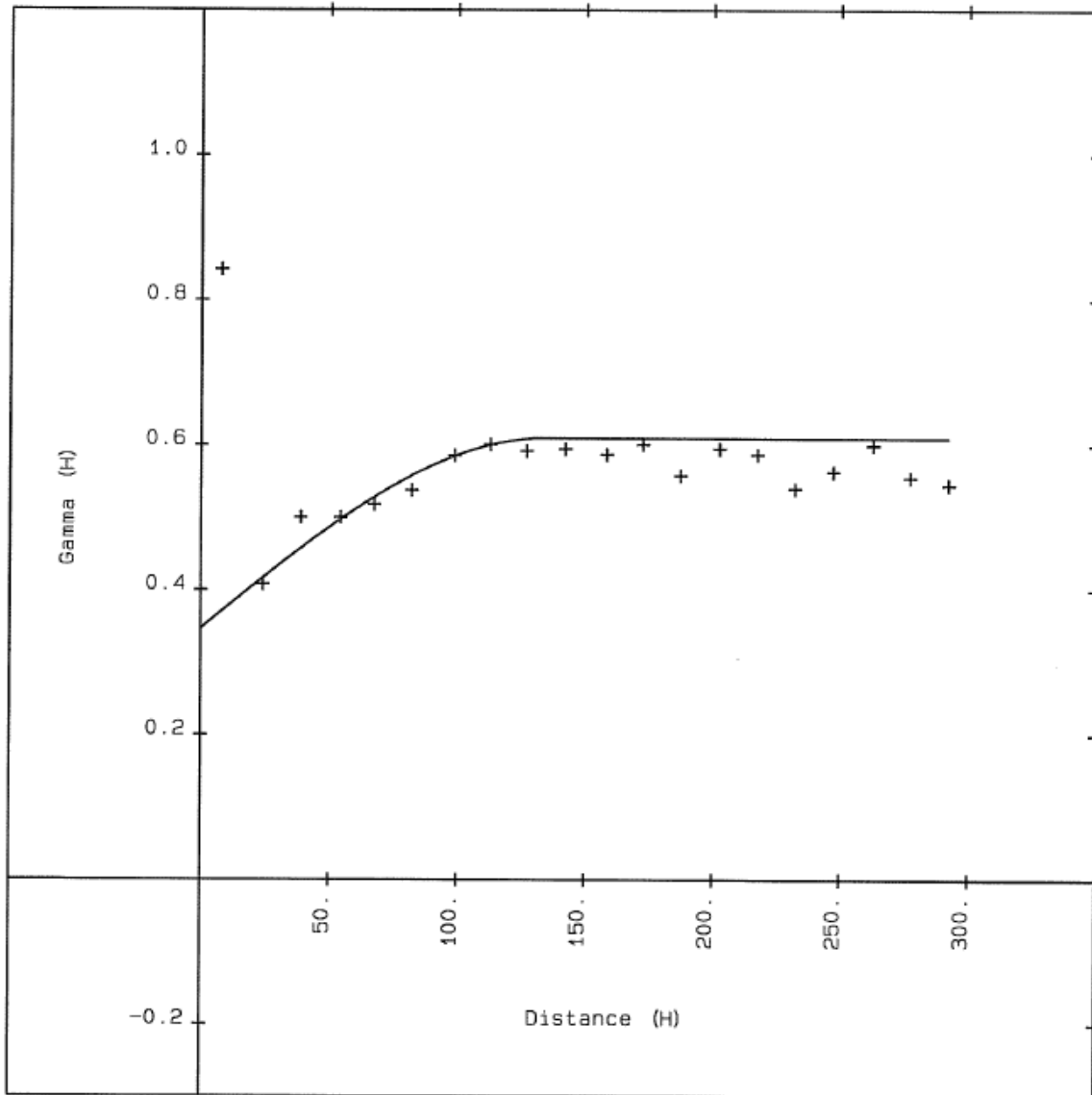

Figure 14.15 NE Domain Gold Variogram – Primary Axis

Gold Northeast Domain - KP Alteration
 GAMMA (H) VARIOGRAM OF: cap_au
 S 30.0 E 15. DIP

Gamma (h)
 * variogram analysis of : cap_au
 data transformation : none
 lag option : 1 class size 15.
 file/variogram number : gamm_KP_NE_gold_P.av 2

azimuth 150.0 direction S 30.0 E
 dip angle 15.0 mean 0.7830
 horizontal window 15.0 variance 0.6100
 vertical window 15.0 no. of samples 4453

spherical: c 0.1765E+00 range 0.8454E+02
 spherical: c 0.2717E+00 range 0.1595E+03
 nugget 0.2770E+00 sill 0.7252E+00

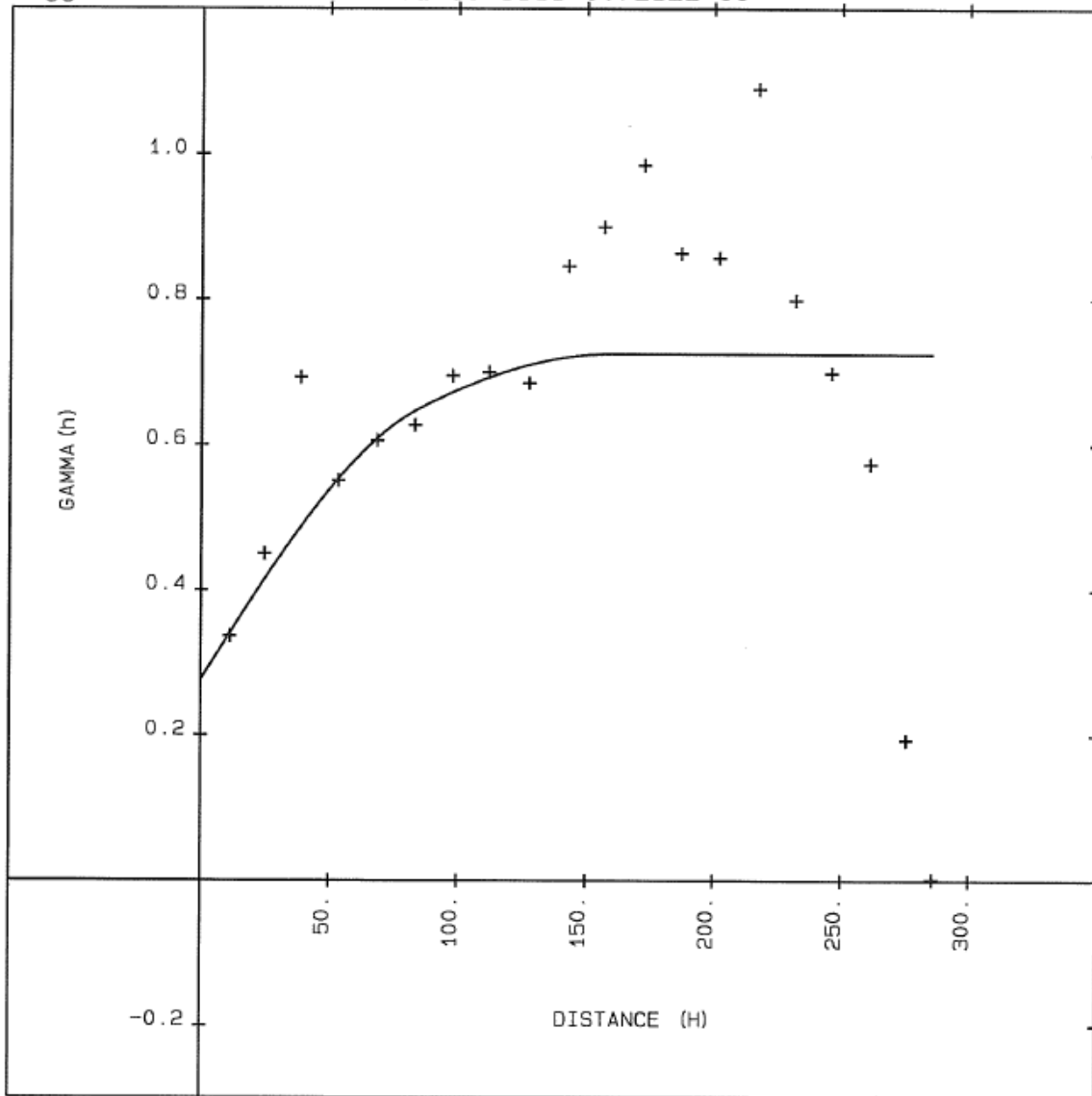

Figure 14.16 NE Domain Gold Variogram – Secondary Axis

NE Domain - KP Alteration
 North Trending Steep Variogram
 Approximately Down Hole Variogram
 GAMMA (H) VARIOGRAM OF: cap_au
 North 60. DIP
 * variogram analysis of : cap_au
 data transformation : none
 lag option : 1 class size 10.
 file/variogram number : gamm_KP_NE_steep.avg 1

azimuth 0.0 direction North
 dip angle 60.0 mean 0.7830
 horizontal window 10.0 variance 0.6100
 vertical window 10.0 no. of samples 4453

spherical: c 0.2064E+00 range0.3241E+02
 spherical: c 0.1951E+00 range0.7517E+02
 nugget 0.3108E+00 sill 0.7123E+00

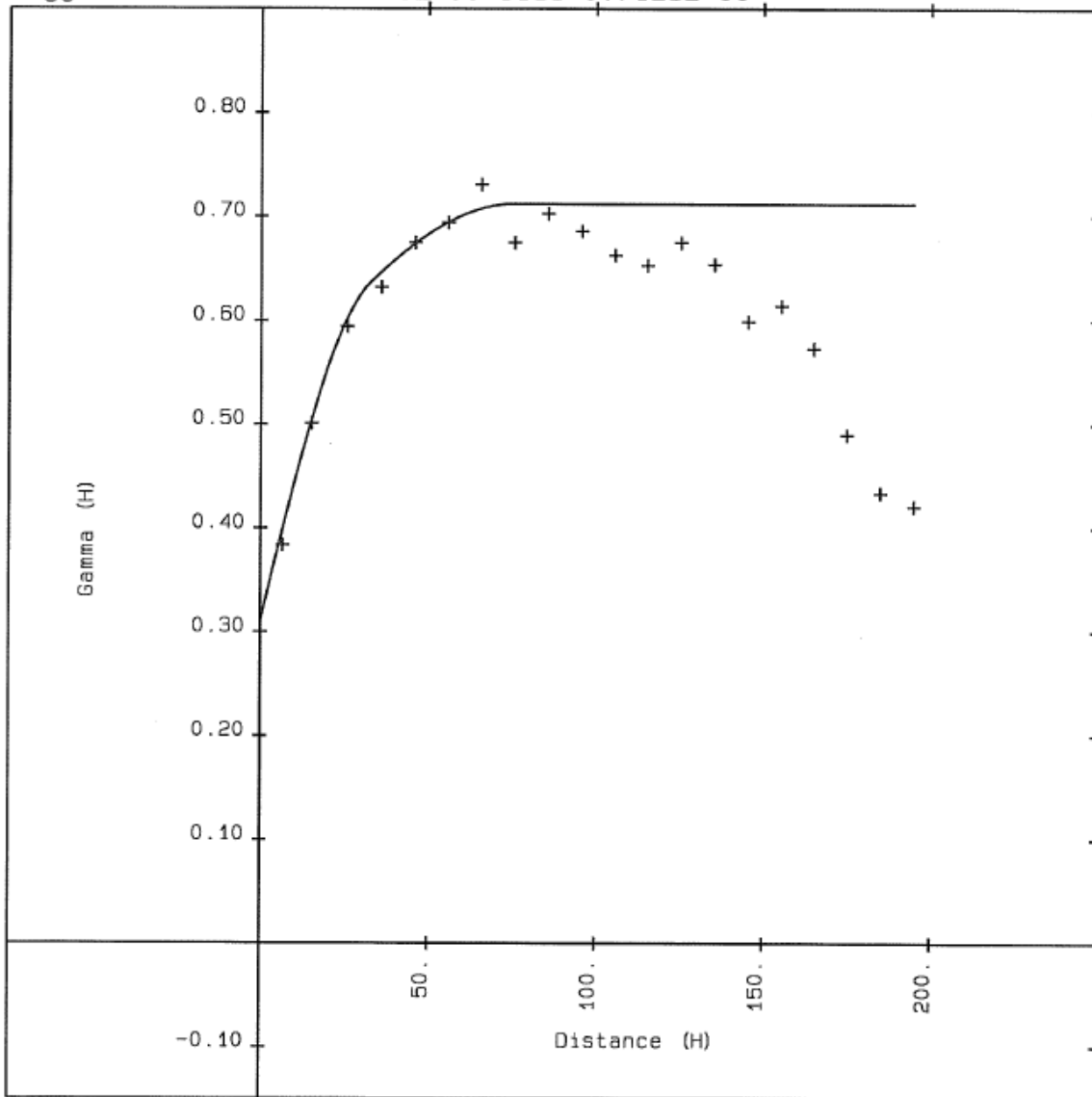

Figure 14.17 NE Domain Gold Variogram – Tertiary Axis

Southwest Domain KP - Southwest Trending Variogram
 PAIRWISE RELATIVE VARIOGRAM OF: cap_au
 S 60.0 W 25. DIP

Pairwise Relative Variogram
 * variogram analysis of : cap_au
 data transformation : none
 lag option : 1 class size 15.
 file/variogram number : gamm_KP_SW_major.avg 3

azimuth 240.0 direction S 60.0 W
 dip angle 25.0 mean 0.9650
 horizontal window 10.0 variance 2.4700
 vertical window 10.0 no. of samples 9278

spherical: c 0.2292E+00 range0.1003E+03
 nugget 0.3758E+00 sill 0.6050E+00

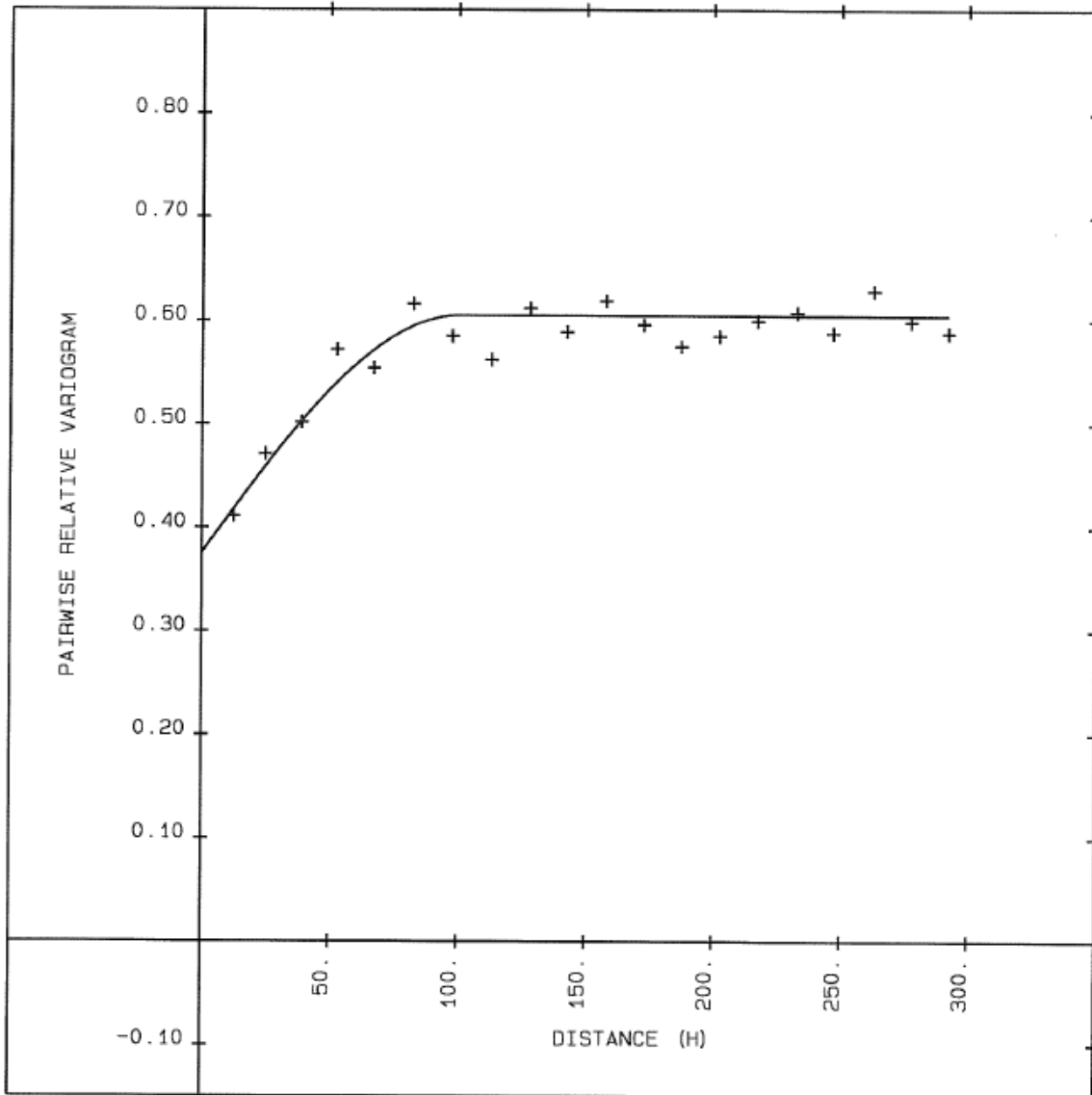

Figure 14.18 SW Domain Gold Variogram – Primary Axis

Gold - SW Domain - KP Alteration
North Trnding Steep (Down Hole) Variogram
GAMMA (H) VARIOGRAM OF: cap_au
North 60 Deg Dip

Gamma (h)
* variogram analysis of : cap_au
data transformation : none
lag option : 1 class size 5.
file/variogram number : gamm_KP_SW_steep.avg 1

azimuth 0.0 direction North
dip angle 60.0 mean 0.9650
horizontal window 10.0 variance 2.4700
vertical window 10.0 no. of samples 9278

spherical: c 0.6154E+00 range0.8195E+01
spherical: c 0.4702E+00 range0.3095E+02
nugget 0.1290E+01 sill 0.2376E+01

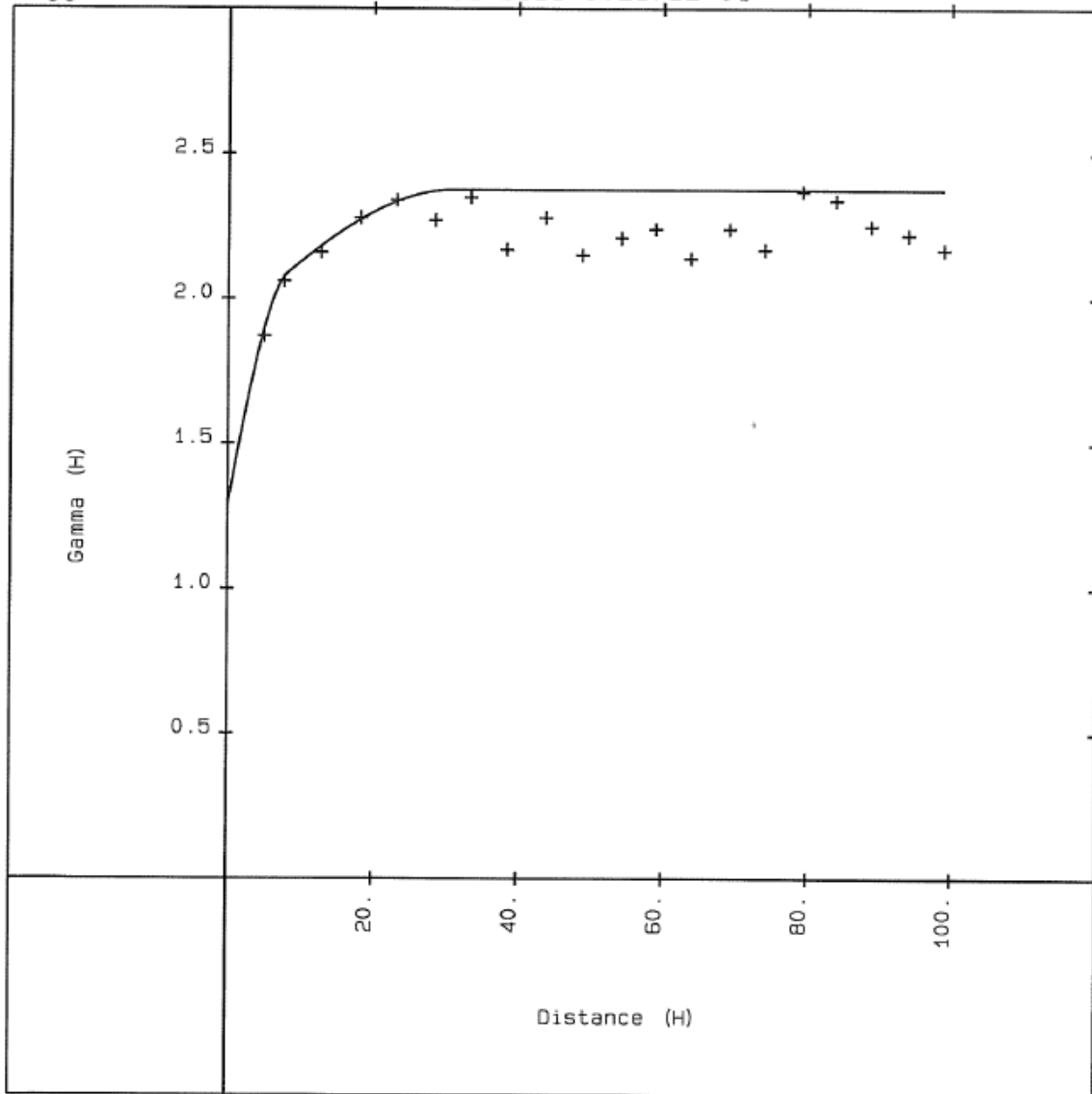

Figure 14.19 SW Domain Gold Variogram – Down Hole Variogram

14.2.6 Block Grade Estimation

The Kp versus Ki alteration types were treated as a hard boundary for estimation purposes. Kp blocks were only estimated with Kp composites, etc. The Indidura/Caracol boundary was also a hard boundary. As was depicted on Table 14-7 there are six domains for grade estimation for gold, silver, lead, and zinc:

- Kp in the NE domain
- Ki in the NE domain
- Kp in the SW domain
- Ki in the SW domain
- Kp in Indidura, and
- Ki in Indidura

The NE and SW domains were not a hard boundary for estimation, but were used to control search orientation. For the NE Caracol (Kp and Ki), the primary axis of the search ellipse had a dip direction and dip of 60° (N60°E) and 0° respectively and the secondary axis had a dip direction and dip of 150° (S30°E) and 15° (down) respectively. The search radii were 100m along the primary and secondary directions and 30m in the tertiary direction.

IMC estimated grades for gold, silver, lead, and zinc using inverse distance with a power weight of 2 (ID2). A maximum of 15 composites, a minimum of three and a maximum of three composites per hole was used. The effect of inverse distance weighting along with a relatively low number of composites should produce relatively unsmoothed estimates of block grades. Also recall that 5m composites were used to estimate the grades of the 10m blocks. Figure 14.20 shows a cross section of the gold grades in the NE domain.

For the SW Caracol (again Kp and Ki), and also the Indidura domains, the primary axis of the search ellipse had a dip direction and dip of 240° (S60°W) and 25° (down). The search radii were 100m along the major axis and 50m, circular, perpendicular to the primary axis.

A maximum of 24 composites, a minimum of four and a maximum of eight composites per hole was used. This is more composites, and more per hole, than was used for the NE domain, but is necessary since there is not as much clarity on the secondary versus tertiary direction in the SW domain. Figure 14.21 shows a cross section of gold grades in the SW domain. Figure 14.22 shows the gold grades on the long section.

Arsenic grades were also estimated and incorporated into the resource model. The estimate was done using the same domains and parameters as gold, silver, lead, and zinc. The estimate was

based on the multi-element data in the database. The upper detection limit for the arsenic assays was 10,000 ppm.

Sulphur grades were also estimated and incorporated into the model. For sulphur, the oxidation types, oxide, transition high, transition low, transition sulphide, and sulphide, were used as hard boundaries for estimation. The Kp and Ki boundaries were also hard boundaries; there tended to be significant breaks in the sulphur grades across these boundaries. The sulphur estimates were also based on multi-element data in the database. The upper detection limit for sulphur was 10%.

Grade estimates for lead, zinc, arsenic and sulphur were also estimated into the waste zones outside of the established resource domains for waste characterization purposes. This also included the post mineral rock type. These estimates were also by Inverse Distance Squared (ID2) with a 100m by 100m by 30m vertical flat search.

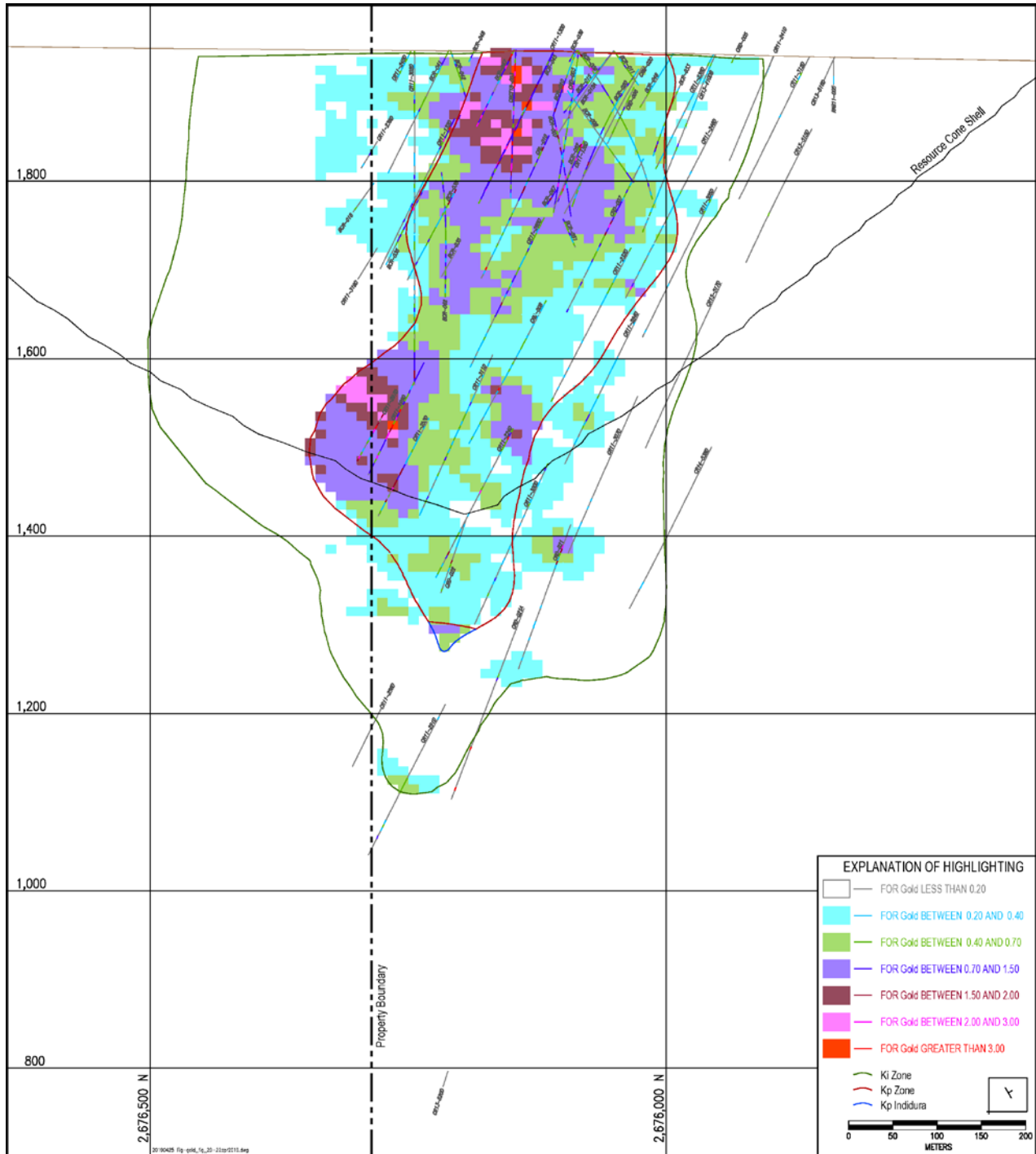

Figure 14.20 Gold Grades on Section 29, IMC 2019

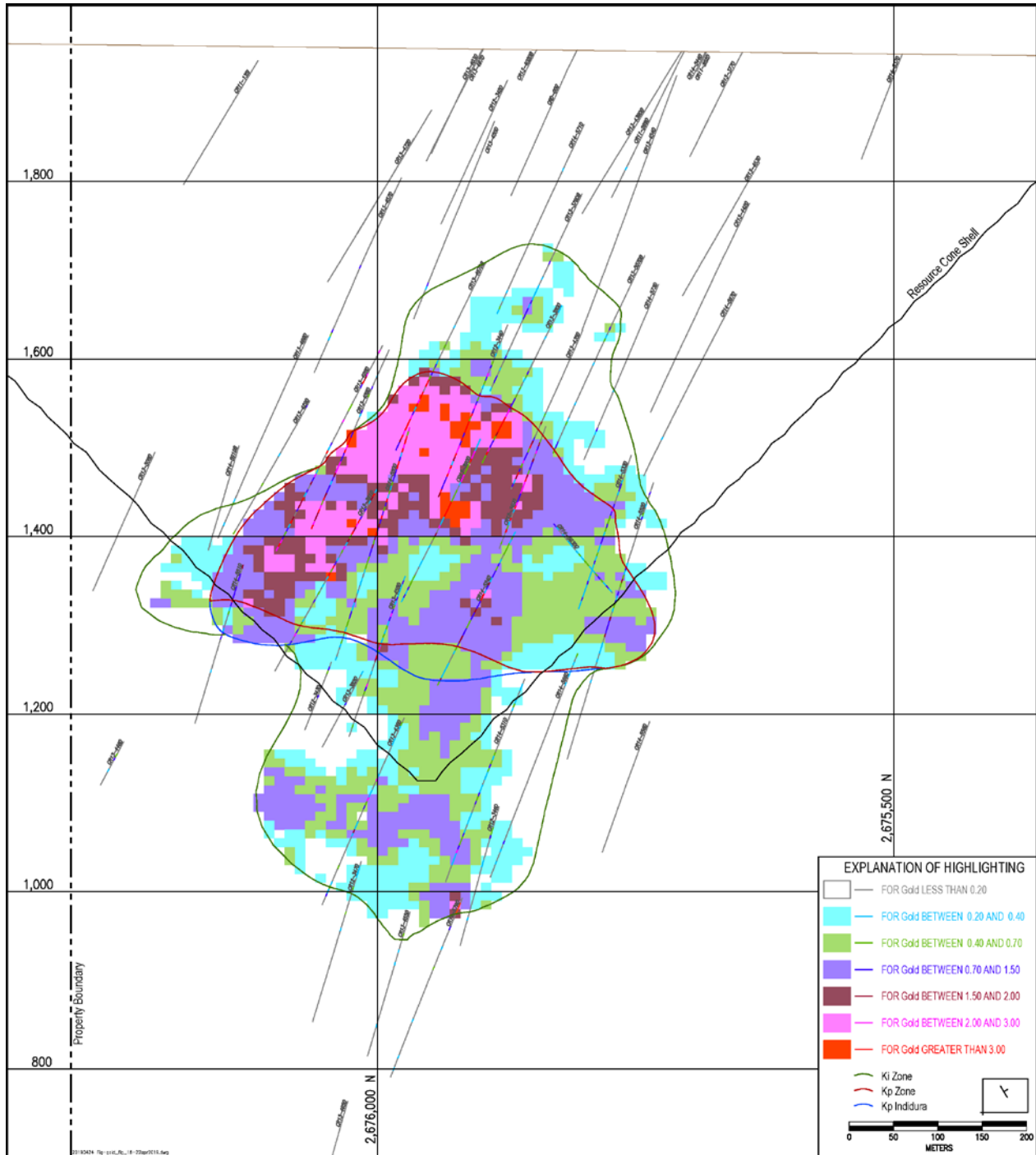

Figure 14.21 Gold Grades on Section 18, IMC 2019

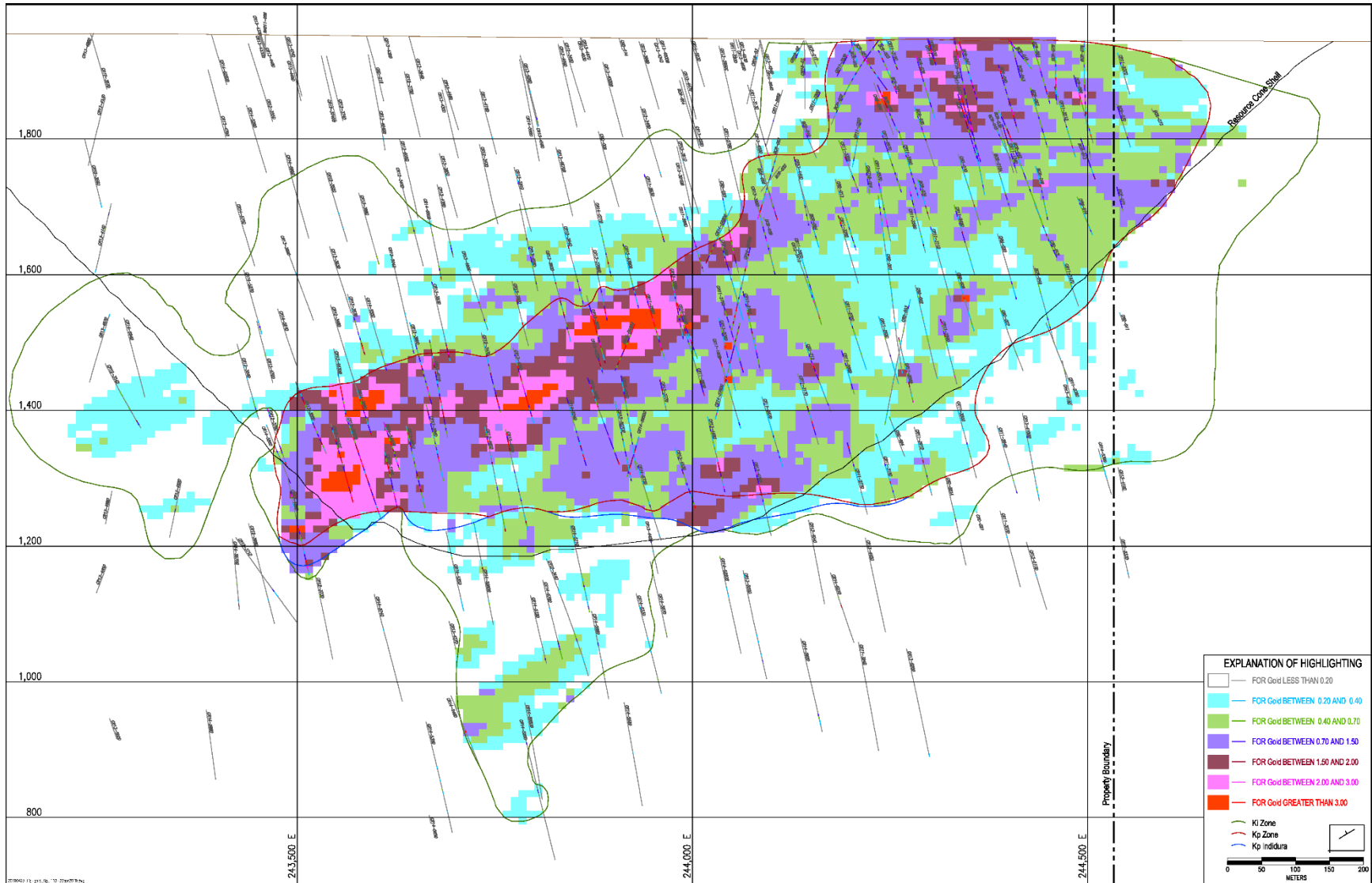

Figure 14.22 Gold Grades on Section L112, IMC 2019

14.2.7 Resource Classification

For the purpose of classifying the Mineral Resources, two additional block estimates were done. They were based on the same search orientations and search radii as the grade estimates. The first estimate was based on a maximum of four composites, a minimum of four, and a maximum of one composite per hole. The second estimate was based on a maximum of three composites, a minimum of three, and a maximum of one composite per hole. These estimates provide the average distance to the nearest three and four holes to each block and were put into the block model. Note the grade from this estimate was not used. Also, the Kp/Ki contact was not used as a hard boundary for these estimations.

Blocks with an average distance to four holes less than or equal to 25m were assigned as Measured Mineral Resource. Blocks with an average distance to the nearest three holes less than 45m, but greater than 25m from the nearest four holes, were assigned as Indicated Mineral Resource. Blocks with an average distance to three holes greater than 45m were assigned to Inferred Mineral Resource. The distribution of drilling at Camino Rojo is quite variable. Generally (not specific to Camino Rojo) an average distance to the nearest four holes of 25m corresponds to an average drill spacing of 30m to 33m. An average distance to the nearest three holes of 45m corresponds to an average drill spacing of about 60m. These estimates are approximate.

After setting classification codes as discussed above, there was some minor reclassification between the Measured and Indicated Mineral Resource categories to do some smoothing and orphan removal using the following procedure:

- First, Indicated blocks with edge contacts with two or more Measured blocks were reclassified as Measured. This is a minor smoothing operation that removed some orphan Indicated blocks and, in some cases, joined up some separate pods of Measured blocks.
- Second, Measured blocks with 0 or 1 edge with other Measured blocks were reclassified as indicated.
- Third, all Measured blocks on the 1640 bench and below were reclassified as Indicated blocks. At depth the Measured blocks are formed into fairly small pods of mostly transition sulphide or sulphide material. It is preferred to not classify this as Measured Mineral Resource.

Figure 14.23, Figure 14.24 and Figure 14.25 show the probability plots for these average distances for the NE, SW, and Indidura domains respectively. The approximate percent of blocks in each resource category are:

	Measured	Indicated	Inferred
Northeast	11.9%	74.9%	13.2%
Southwest	1.9%	60.2%	37.9%
Indidura	0.8%	34.7%	64.5%

Figure 14.26 and Figure 14.27 show the resource categories on cross sections.

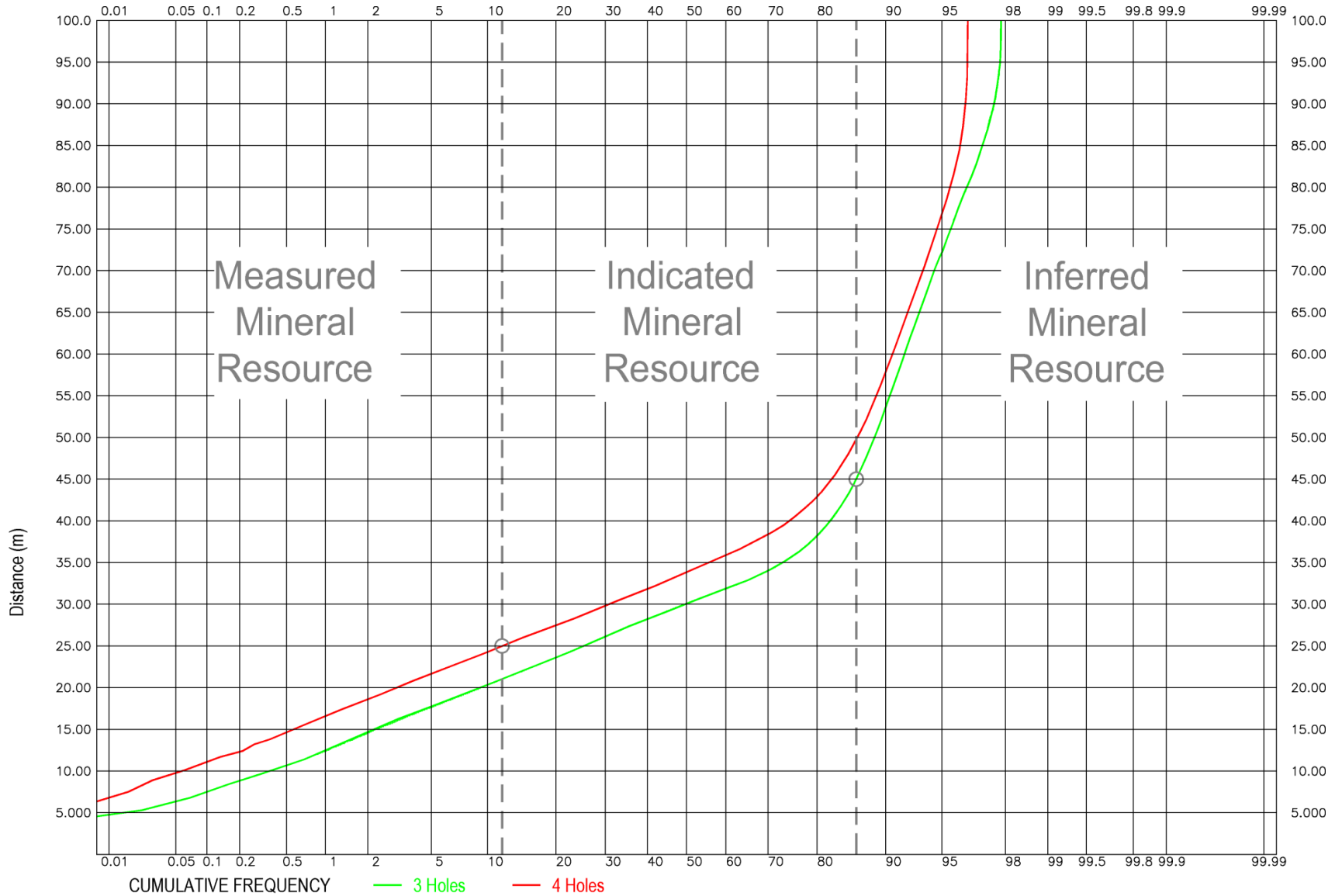

Probability Plot of Average Distance to Nearest 3 and 4 Holes - NE Kp and Ki Domains

Figure 14.23 Average Distance to Nearest 3 & 4 Holes – NE Kp & Ki Domains

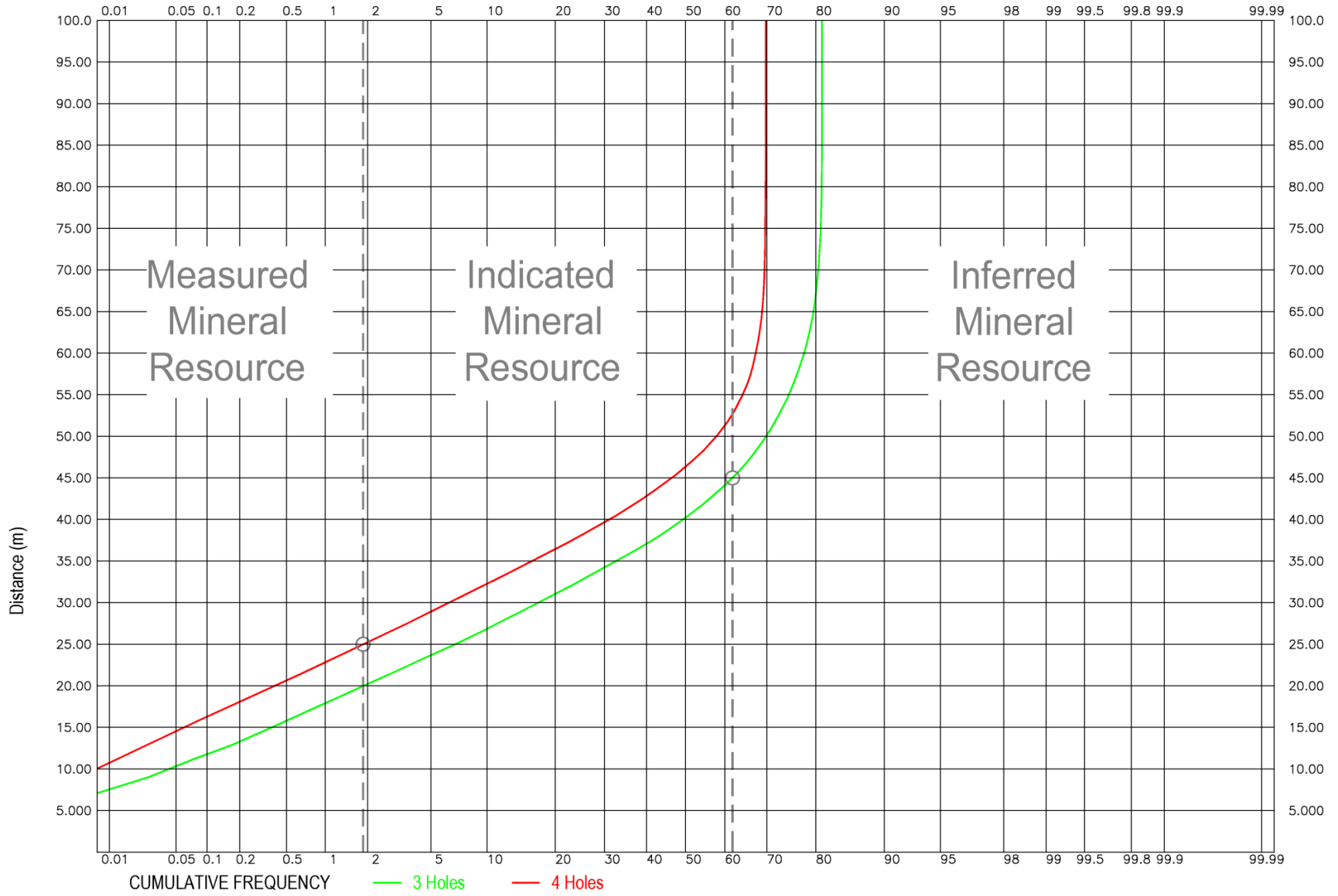

Probability Plot of Average Distance to Nearest 3 and 4 Holes - SW Kp and Ki Domains

Figure 14.24 Average Distance to Nearest 3 & 4 Holes – SW Kp & Ki Domains

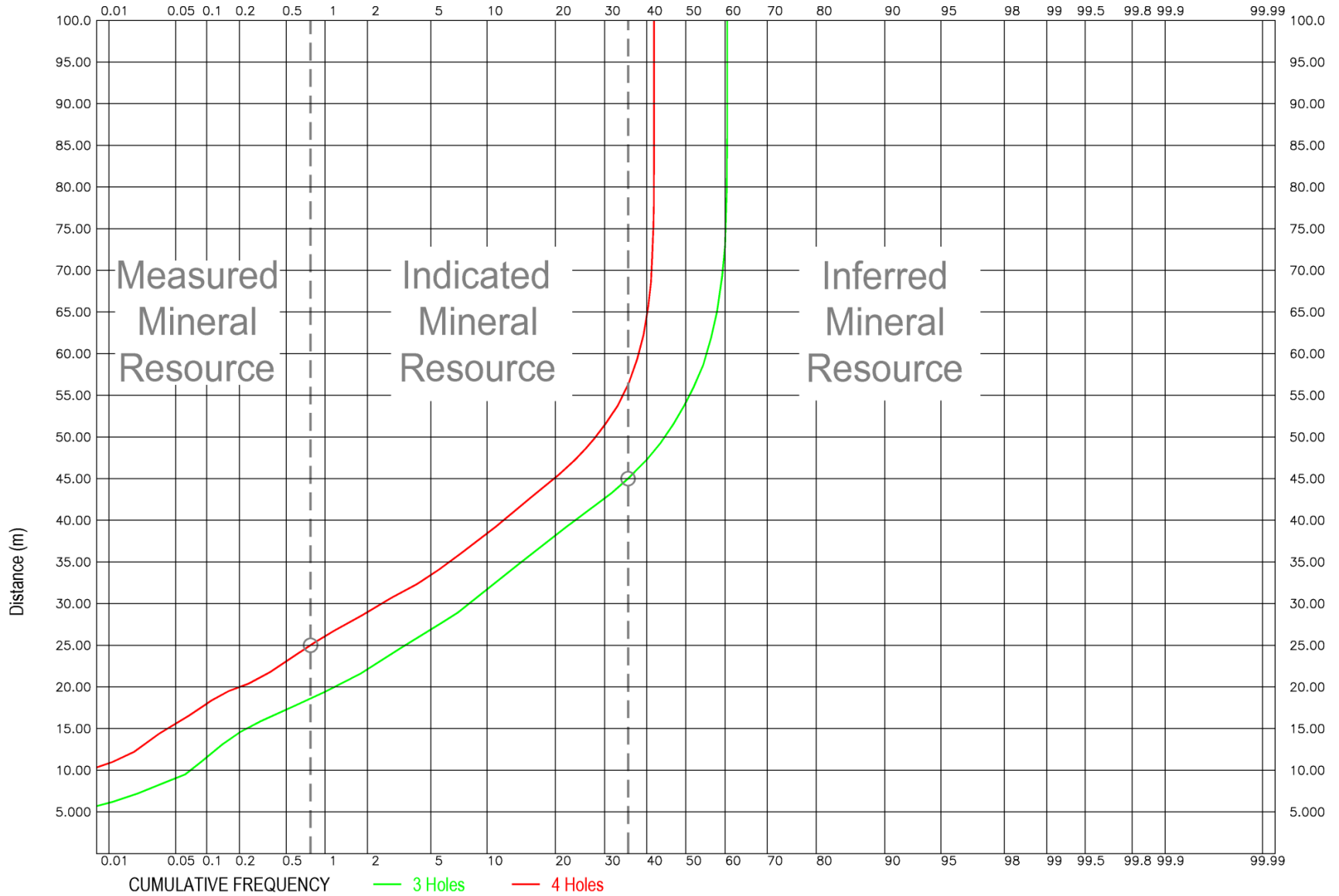

Probability Plot of Average Distance to Nearest 3 and 4 Holes - Indidura Kp and Ki Domains

Figure 14.25 Average Distance to Nearest 3 & 4 Holes – Indidura Kp & Ki Domains

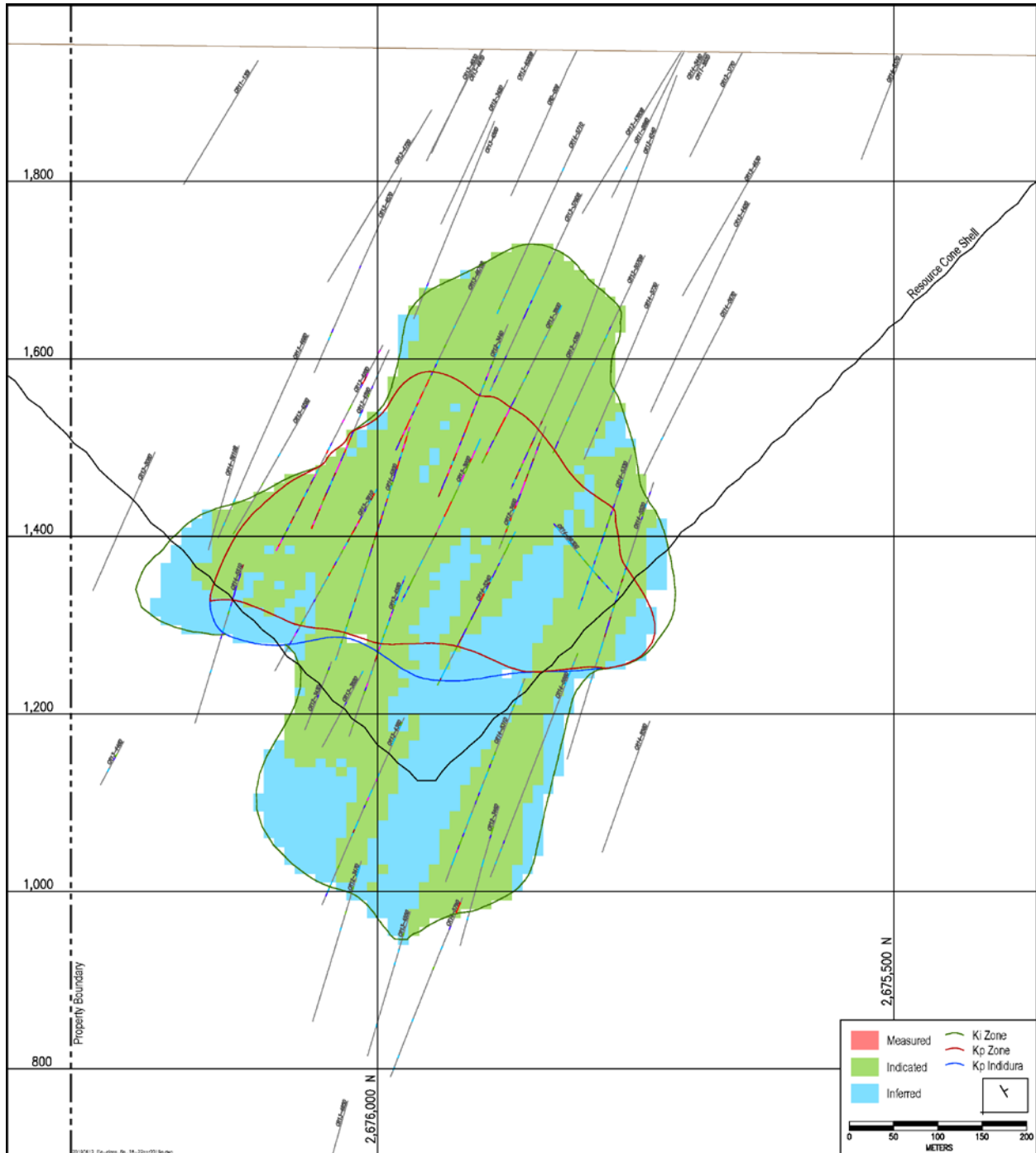

Figure 14.26 Resource Categories on Section 18, IMC 2019

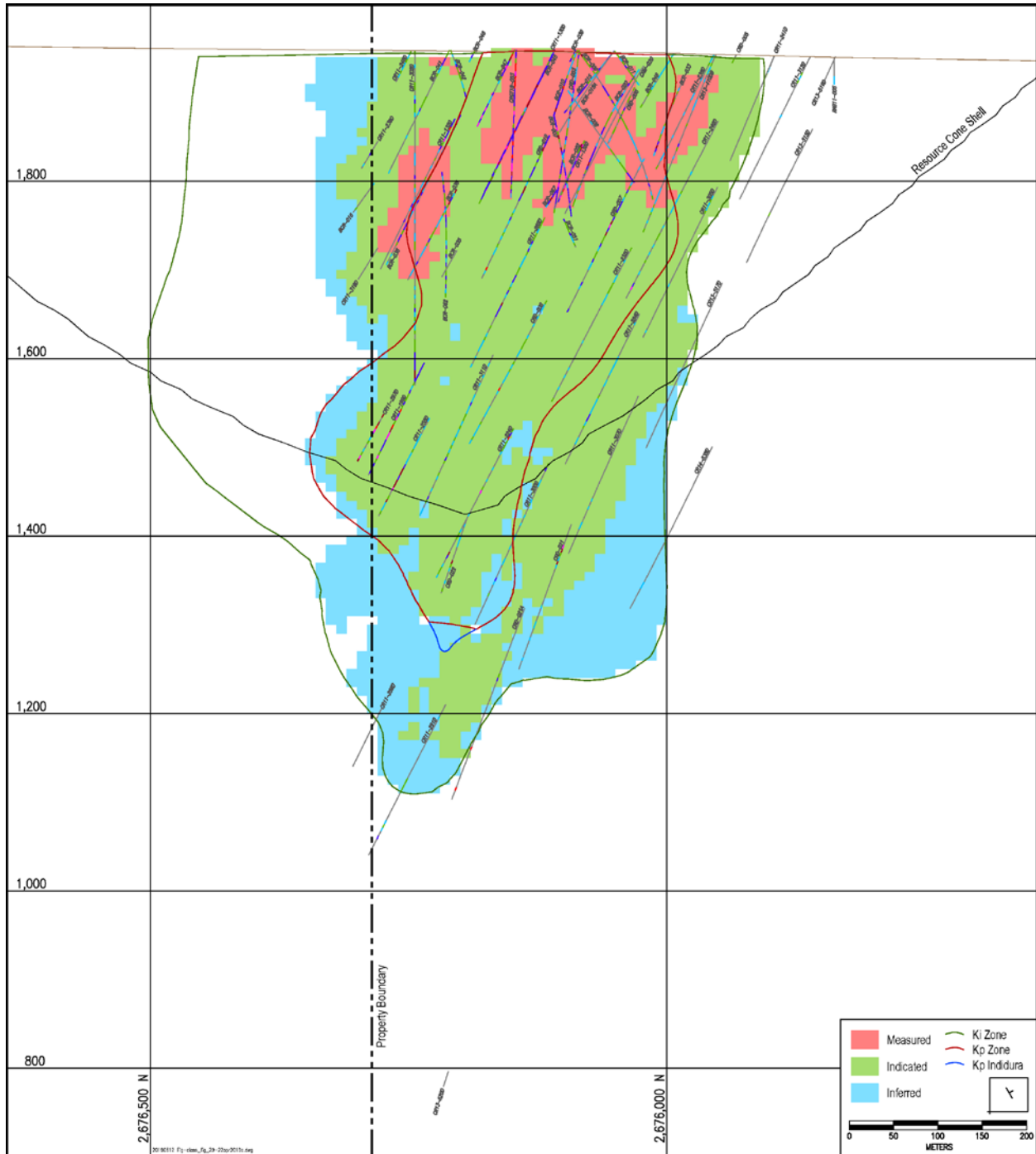

Figure 14.27 Resource Categories on Section 29, IMC 2019

14.2.8 Bulk Density

The database included about 10,000 specific gravity and density tests conducted on core. Some were based on the wax immersion method, but most were based on cutting whole core to obtain small cylinders and measuring them to obtain the volume; they were then weighed.

IMC examined this data by rock type and oxidation type. Table 14-12 shows the results.

Table 14-12
Specific Gravity and Bulk Density

Lithology	Oxidation	No. of Samples	Specific Gravity	Bulk Factor	Bulk Density	Ktonnes/Block
Post Min	Ox	183	1.994	0.98	1.954	1.954
Caracol	Ox, TrH	703	2.458	0.98	2.409	2.409
Caracol	TrL, TrS	778	2.550	0.98	2.499	2.499
Caracol	Slf	6450	2.618	0.98	2.566	2.566
Indura	TrS, Slf	1915	2.664	0.98	2.611	2.611

The post mineral rock types averaged about 2.0. For the Caracol unit there were measurable differences based on the level of oxidation. The oxide and TrH material averaged about 2.46, The TrL and TrS material about 2.55, and the sulphide about 2.62. The Indidura unit averaged about 2.66.

The average specific gravity was reduced 2% to obtain an estimate of bulk density. This is to allow for voids in the rock mass at a larger scale than what could be captured in the small core samples.

14.2.9 Mineral Resource Reconciliation

14.2.9.1 Leach Material

A reconciliation of the current Mineral Resource, dated June 7, 2019, with the April 27, 2018 Mineral Resource, developed for the PEA study, was conducted. The Mineral Resource includes material amenable to heap leach recovery methods (leach material) and material amenable to mill and flotation concentration methods (mill material).

Table 14-13 shows the results for leach material. The portion of the April 27, 2018 Measured and Indicated Mineral Resource that was potentially leachable amounted to 100.8 million tonnes at 0.734 g/t gold and 12.67 g/t silver for 2.38 million contained gold ounces and 41.1 million contained silver ounces.

For the current Measured and Indicated Mineral Resource, the material that is potentially leachable amounts to 94.6 million tonnes at 0.711 g/t gold and 12.74 g/t silver for 2.16 million contained gold ounces and 38.8 million contained silver ounces. This amounts to 6.1% less tonnes at a 3.2% lower gold grade, a 0.5% higher silver grade for 9.2% less contained gold ounces and 5.6% less contained silver ounces for Measured and Indicated Mineral Resource.

The difference in Measured and Indicated Mineral Resource tonnes amounts to 6.2 million tonnes and is primarily due to differences in the interpretation of the oxide domains. There was a decrease in oxide and trans-low material and an increase of trans-sulf and sulfide (mill material) in the new resource model, i.e. there is a net transfer of material from leach material to mill material.

The main contributor to the 3.2% lower gold grade is the elimination of the potentially contaminated wet RC samples. It does not appear the new Orla drilling or revised geologic interpretations were significant contributors to the gold grade change.

There was also a net transfer of Mineral Resource from the Indicated to the Measured category for the leach material. This is due to some revisions in the classification methods described in Section 14.2.7 compared to the April 27, 2018 Mineral Resource. There was not much net change in classification due to drilling; the new Orla drilling and the elimination of potentially contaminated RC samples about balanced each other in terms of drilling density.

It is also noted that the differences in Mineral Resources are almost exclusively due to model differences. The cone shell used to define the Mineral Resource was about the same for both cases and the changes due to economic parameters and cutoff grades are not significant.

14.2.9.2 *Mill Material*

Table 14-14 shows the reconciliation for mill material. The portion of the April 27, 2018 Measured and Indicated Mineral Resource that was potential mill material amounted to 254.1 million tonnes at 0.889 g/t gold and 7.50 g/t silver for 7.26 million ounces of contained gold and 61.3 million contained silver ounces.

For the current Measured and Indicated Mineral Resource, the material that is potentially millable amounts to 258.8 million tonnes at 0.877 g/t gold and 7.40 g/t silver for 7.30 million contained gold ounces and 61.6 million contained silver ounces. This amounts to 1.9% more tonnes at a 1.4% lower gold grade, a 1.3% lower silver grade for 0.4% more contained gold ounces and 0.5% more contained silver ounces for Measured and Indicated Mineral Resource.

The 4.7 million tonne increase in Measured and Indicated Mineral Resources is due primarily to the difference in the interpretation of the oxide domains, as discussed in the previous section. The gold and silver grade changes are minimal, but are due mostly to exclusion of the potentially contaminated RC samples.

The amount of Measured Mineral Resource in the potential mill material is minimal, but there has been a net transfer of material from the Measured to Indicated category for this material. As described in Section 14.2.7, Measured Mineral Resource below the 1640 bench were reclassified as Indicated Mineral Resource for the current Mineral Resource.

14.2.9.3 *Total Leach Plus Mill Material*

Table 14-15 shows the reconciliation for the Mineral Resource, including the leach and mill material. For Measured and Indicated Mineral Resource the current Mineral Resource has 0.4% less tonnes at a 1.5% lower gold grade and 1.5% lower silver grade for 1.9% less contained gold ounces and 2.0% less contained silver ounces. There is virtually no change to the overall Mineral Resource estimate.

Table 14-13
Reconciliation of 2018 versus 2019 Mineral Resource - Leach Material

Resource Model	Kt	Gold (g/t)	Silver (g/t)	Gold (koz)	Silver (koz)
April 27, 2018 Mineral Resource					
Measured Mineral Resource	16,147	0.79	15.4	412.1	8,014
Indicated Mineral Resource	84,692	0.72	12.1	1,969.3	33,076
Meas/Ind Mineral Resource	100,839	0.73	12.7	2,381.3	41,091
Inferred Mineral Resource	4,858	0.77	5.6	120.6	874
Current Mineral Resource - June 7, 2019					
Measured Mineral Resource	19,391	0.77	14.9	482.3	9,305
Indicated Mineral Resource	75,249	0.69	12.2	1,680.7	29,471
Meas/Ind Mineral Resource	94,640	0.71	12.7	2,163.0	38,776
Inferred Mineral Resource	4,355	0.86	5.8	119.8	805
Percent Difference					
Measured Mineral Resource	20.1%	-2.5%	-3.3%	17.1%	16.1%
Indicated Mineral Resource	-11.1%	-3.9%	0.3%	-14.7%	-10.9%
Meas/Ind Mineral Resource	-6.1%	-3.2%	0.5%	-9.2%	-5.6%
Inferred Mineral Resource	-10.4%	10.9%	2.8%	-0.6%	-7.9%

Table 14-14
Reconciliation of 2018 versus 2019 Mineral Resource - Mill Material

Resource Model	Kt	Gold (g/t)	Silver (g/t)	Gold (koz)	Silver (koz)
April 27, 2018 Mineral Resource					
Measured Mineral Resource	9,818	0.86	7.5	272.6	2,352
Indicated Mineral Resource	244,251	0.89	7.5	6,992.2	58,934
Meas/Ind Mineral Resource	254,069	0.89	7.5	7,264.8	61,286
Inferred Mineral Resource	60,342	0.87	7.9	1,696.9	15,334
Current Mineral Resource - June 7, 2019					
Measured Mineral Resource	3,358	0.69	9.2	74.2	997
Indicated Mineral Resource	255,445	0.88	7.4	7,221.4	60,606
Meas/Ind Mineral Resource	258,803	0.88	7.4	7,295.6	61,603
Inferred Mineral Resource	56,564	0.87	7.5	1,576.9	13,713
Percent Difference					
Measured Mineral Resource	-65.8%	-20.5%	23.9%	-72.8%	-57.6%
Indicated Mineral Resource	4.6%	-1.2%	-1.7%	3.3%	2.8%
Meas/Ind Mineral Resource	1.9%	-1.4%	-1.3%	0.4%	0.5%
Inferred Mineral Resource	-6.3%	-0.9%	-4.6%	-7.1%	-10.6%

Table 14-15
Reconciliation of 2018 versus 2019 Mineral Resource - Leach & Mill Material

Resource Model	Kt	Gold (g/t)	Silver (g/t)	Gold (koz)	Silver (koz)
April 27, 2018 Mineral Resource					
Measured Mineral Resource	25,965	0.82	12.4	684.6	10,367
Indicated Mineral Resource	328,943	0.85	8.7	8,961.5	92,010
Meas/Ind Mineral Resource	354,908	0.85	9.0	9,646.1	102,377
Inferred Mineral Resource	65,200	0.87	7.7	1,817.5	16,208
Current Mineral Resource - June 7, 2019					
Measured Mineral Resource	22,749	0.76	14.1	556.5	10,302
Indicated Mineral Resource	330,694	0.84	8.5	8,902.1	90,078
Meas/Ind Mineral Resource	353,443	0.83	8.8	9,458.6	100,379
Inferred Mineral Resource	60,919	0.87	7.4	1,696.7	14,518
Percent Difference					
Measured Mineral Resource	-12.4%	-7.2%	13.4%	-18.7%	-0.6%
Indicated Mineral Resource	0.5%	-1.2%	-2.6%	-0.7%	-2.1%
Meas/Ind Mineral Resource	-0.4%	-1.5%	-1.5%	-1.9%	-2.0%
Inferred Mineral Resource	-6.6%	-0.1%	-4.1%	-6.6%	-10.4%

15.0 MINERAL RESERVE ESTIMATE

15.1 Mineral Reserve

Table 15-1 presents the Mineral Reserve estimate for the Camino Rojo Project. The Proven and Probable Mineral Reserves amounts to 67.4 million tonnes at 0.73 g/t Au and 14.5 g/t Ag for 1.59 million contained gold ounces and 31.5 million contained silver ounces. Direct feed material in the Mineral Reserves is material that will be processed the same year it is mined. The low-grade stockpile material will be processed after the open pit is depleted. The effective date of this Mineral Reserve estimate is 11 January 2021.

The Mineral Reserve estimate is based on an open pit mine plan and mine production schedule developed by IMC. Processing is based on crushing and heap leaching to recover gold and silver. Table 15-2 shows the parameters used for economic and cut-off calculations. The Mineral Reserve estimate is based on a gold price of US\$1250 per ounce and a silver price of US\$17.00 per ounce. Measured Mineral Resource in the mine production schedule was converted to Proven Mineral Reserve and Indicated Mineral Resource in the schedule was converted to Probable Mineral Reserve.

The Mineral Reserves are classified in accordance with the “CIM Definition Standards – For Mineral Resources and Mineral Reserves” adopted by the CIM Council (as amended, the “CIM Definition Standards”) in accordance with the requirements of NI 43-101. Mineral Reserve estimates reflect the reasonable expectation that all necessary permits and approvals will be obtained and maintained. The Project is in a jurisdiction friendly to mining.

IMC does not believe that there are significant risks to the Mineral Reserve estimate based on metallurgical or infrastructure factors or environmental, permitting, legal, title, taxation, socio-economic, marketing or political factors. There has been a significant amount of metallurgical testing and the infrastructure requirements are relatively straightforward compared to many operations. However, recoveries lower than forecast would result in loss of revenue for the project. There has also been some potential preg-robbing material identified in the deposit, as discussed in Section 13.5 and 25.3.2, but this does not appear to represent a significant risk.

There is risk to the Mineral Reserve estimate based on mining factors. As discussed in Section 16.2 and 25.3.1, the slope angle assumptions are based on careful application of wall control blasting. Failure of the wall control blasting to perform as expected would result in less ore available for the process plant and potentially a shorter project life.

Other risks to the Mineral Reserve estimate are related to economic parameters such as prices lower than forecast or costs higher than the current estimates. The impact of these is modeled in the sensitivity study with the economic analysis in Section 22.10.

All of the mineralization comprised in the Mineral Reserve estimate with respect to the Camino Rojo Project is contained on mineral titles controlled by Orla. A portion of the waste mining will be on a mineral concession controlled by Fresnillo as per the Layback Agreement between Orla and Fresnillo. Additional work is required to bring material on the Fresnillo concession to the Measured and Indicated Mineral Resource categories. Therefore, all material to be mined on the Fresnillo mineral concession is considered waste in this Technical Report.

Approximately two-thirds of the Mineral Reserves are within the currently permitted mine plan. The remaining portion will require a CUS and related permit amendments for an expanded pit and approval of the Layback Agreement from COFECE and subsequent transfer of surface rights.

**Table 15-1
Mineral Reserve Estimate**

Reserve Class	Ktonnes	NSR (\$/t)	Gold (g/t)	Silver (g/t)	Cont. Gold (koz)	Cont. Silver (koz)
Proven Mineral Reserve						
Direct Feed	15,997	23.04	0.87	16.2	445	8,322
Low Grade Stockpile	2,070	8.03	0.31	9.5	20	629
Total Proven Mineral Reserve	18,067	21.32	0.80	15.4	466	8,951
Probable Mineral Reserve						
Direct Feed	42,123	20.04	0.78	15.2	1,052	20,596
Low Grade Stockpile	7,173	7.77	0.31	8.5	71	1,959
Total Probable Mineral Reserve	49,296	18.25	0.71	14.2	1,123	22,555
Proven/Probable Mineral Reserve						
Direct Feed	58,120	20.86	0.80	15.5	1,497	28,918
Low Grade Stockpile	9,243	7.83	0.31	8.7	92	2,588
Total Proven/Probable Reserve	67,363	19.08	0.73	14.5	1,588	31,506

Notes:

- The Mineral Reserve estimate has an effective date of 11 January 2021 and was prepared using the CIM Definition Standards (10 May 2014).
- Columns may not sum exactly due to rounding.
- Mineral Reserves are based on prices of \$1250/oz gold and \$17/oz silver.
- Mineral Reserves are based on NSR cut-offs that vary by time period to balance mine and plant production capacities (see Section 16). They range from a low of \$4.93/t to a high of \$12.00/t.
- NSR value for leach material is as follows:
 - Kp Oxide: NSR (\$/t) = 27.37 x gold (g/t) + 0.053 x silver (g/t), based on gold recovery of 70% and silver recovery of 11%
 - Ki Oxide: NSR (\$/t) = 21.90 x gold (g/t) + 0.073 x silver (g/t), based on gold recovery of 56% and silver recovery of 15%
 - Tran-Hi: NSR (\$/t) = 23.46 x gold (g/t) + 0.131 x silver (g/t), based on gold recovery of 60% and silver recovery of 27%
 - Tran-Lo: NSR (\$/t) = 15.64 x gold (g/t) + 0.165 x silver (g/t), based on gold recovery of 40% and silver recovery of 34%
- Table 15-2 accompanies this Mineral Reserve estimate and shows all relevant parameters

15.2 Economic Parameters

Table 15-2 shows the parameters for pit design. Only gold and silver are produced for this plan and the only material types considered are the Kp Oxide, Ki Oxide, Transitional Hi, and Transitional Low.

Gold and silver prices used in the Mineral Reserve estimate were US\$1250 per ounce and US\$17 per ounce respectively. IMC believes these prices to be reasonable based on: 1) Historical 3-year trailing averages, 2) prices used by other companies for comparable projects, and 3) long range consensus price forecasts prepared by various bank economists.

For mine design, the base mining cost was estimated at US\$1.90 per tonne moved. This was estimated based on a calculated owner mining cost plus an allowance for equipment depreciation and contractor profit for a Camino Rojo unconstrained mine plan similar to the current Feasibility Study. An allowance of US\$0.05 per tonne for pit dewatering has also been included to bring the total mining cost, for design purposes, to US\$1.95 per total tonne.

The unit costs for mining, processing, and G&A shown in Table 15-2 are preliminary estimates used for design. These differ from the final cost estimates developed by this Technical Report that were developed using the design mine plan. The final cost estimates used for the economic analysis are presented in Section 21.

Processing is by crushing and heap leaching at a rate of 18,000 tonnes per day or about 6.57 million tonnes per year. The gold and silver recoveries presented in Table 15-2 were developed by KCA in March 2019 and are based on historical metallurgical testing and the new testing conducted during 2018 and 2019. They are the same as the gold and silver recoveries used in the Feasibility Study contained in the 2019 Technical Report.

The processing and G&A costs of US\$3.38 and US\$1.55 respectively per processed tonne are the resultant costs from the financial analysis used in Feasibility Study contained in the 2019 Technical Report.

The gold and silver refinery payable amounts, the gold and silver refining costs, and the royalty amounts are the values used for the financial analysis for the Feasibility Study contained in the 2019 Technical Report. The royalty includes the 2% NSR royalty payable to Maverix Metals Inc. and the 0.5% Extraordinary Mining Duty payable to the Mexican government, as mandated by Federal Law.

Due to two products, and also variable recoveries by material type, an NSR value was used to tabulate proposed quantities of Mineral Reserves. The gold and silver NSR factors for Kp Oxide are calculated as follows:

$$\text{Gold NSR Factor} = (\$1250 - \$1.40) \times 0.70 \times 0.999 \times 0.975 / 31.103 = \text{US\$27.371/t}$$

$$\text{Silver NSR Factor} = (\$17 - \$1.20) \times 0.11 \times 0.98 \times 0.975 / 31.103 = \text{US\$0.0534/t}$$

The units are US\$ per gram per tonne. The 0.975 constant represents an allowance for the royalty cost.

The NSR value for a block is calculated as:

$$\text{NSR} = \text{US\$27.371} \times \text{gold grade} + \text{US\$0.0534} \times \text{silver grade}$$

The breakeven NSR cut-off is US\$6.88 per tonne, the mining + process + G&A. The internal NSR cut-off is US\$4.93 per tonne, the process + G&A cost. Internal cut-off applies to blocks that have to be removed from the pit, so mining is a sunk cost. Note the NSR cut-off does not vary by material type, so is convenient for mine planning and scheduling. The NSR factors and cut-offs for the other material types are also shown in the table

The Mineral Reserves are based on NSR cutoffs that vary by time period to balance mine and plant production capacities. They range from a low of US\$4.93/t to a high of US\$12.00/t.

The Mineral Reserves include allowances for mining dilution and ore loss. IMC believes that reasonable amounts of dilution and loss were incorporated into the block model used for this Technical Report. Compositing assays into composites and estimating blocks with multiple composites introduces some smoothing of model grades that are analogous to dilution and ore loss effects.

Only Measured and Indicated Mineral Resource are allowed to contribute to the economics for the Feasibility Study and be converted to Mineral Reserves. Inferred Mineral Resource is treated as waste for this Technical Report.

**Table 15-2
Economic Parameters for Mine Design**

Material Type	Units	Kp Oxide	Ki Oxide	Tran-Hi	Tran-Low	Waste
Commodity Prices						
Gold Price Per Ounce	(US\$)	1250	1250	1250	1250	
Silver Price Per Ounce	(US\$)	17.00	17.00	17.00	17.00	
Mining Cost Per Tonne						
Contract Mining Cost	(US\$)	1.900	1.900	1.900	1.900	1.900
Allowance for Pit Dewatering	(US\$)	0.050	0.050	0.050	0.050	0.050
Total Mining Cost	(US\$)	1.950	1.950	1.950	1.950	1.950
Process and G&A Cost Per Ore Tonne						
Processing	(US\$)	3.380	3.380	3.380	3.380	
G&A	(US\$)	1.550	1.550	1.550	1.550	
Total Process and G&A	(US\$)	4.930	4.930	4.930	4.930	
Plant Recovery						
Gold	(%)	70%	56%	60%	40%	
Silver	(%)	11%	15%	27%	34%	
Refinery Payables and Costs						
Gold Refinery Payable	(%)	99.9%	99.9%	99.9%	99.9%	
Silver Refinery Payable	(%)	98.0%	98.0%	98.0%	98.0%	
Gold Refining Per Ounce	(US\$)	1.40	1.40	1.40	1.40	
Silver Refining Per Ounce	(US\$)	1.20	1.20	1.20	1.20	
Royalties						
Royalty	(%)	2.5%	2.5%	2.5%	2.5%	
NSR Factors						
Gold NSR Factor	(\$/g)	27.371	21.897	23.461	15.641	
Silver NSR Factor	(\$/g)	0.0534	0.0728	0.1311	0.1650	
NSR Cutoff Grades						
Breakeven NSR Cutoff Grade	(\$/t)	6.88	6.88	6.88	6.88	
Internal NSR Cutoff Grade	(\$/t)	4.93	4.93	4.93	4.93	

16.0 MINING METHODS

16.1 Operating Parameters and Criteria

The Feasibility Study is based on a conventional open pit mine. Mine operations will consist of drilling medium diameter blast holes (approximately 17 cm), blasting with explosive emulsions or ANFO (ammonium nitrate/fuel oil) depending on water conditions, and loading into large off-road trucks with hydraulic shovels and wheel loaders. Resource will be delivered to the primary crusher and waste to the waste storage facility southeast of the pit. There will also be a low-grade stockpile facility to store marginally economic Mineral Reserves for processing at the end of commercial pit operations. There will be a fleet of track dozers, rubber-tired dozers, motor graders and water trucks to maintain the working areas of the pit, waste storage areas, and haul roads.

A mine plan was developed to supply Mineral Reserves to a conventional crushing and heap leach plant with the capacity to process 18,000 tpd (6,570 ktpy). The mine is scheduled to operate two 10-hour shifts per day for 365 days per year.

The mine plan contained in this Technical Report was prepared on the assumption that Orla would be permitted to expand the Camino Rojo Project oxide pit onto part of Fresnillo's mineral concession located immediately north of Orla's property, that Orla will have access to oxide and transitional heap leachable material, and that Orla would have the right to mine from Fresnillo's mineral concession, and recover for Orla's account, all oxide and transitional material amenable to heap leaching that are within an expanded open pit. In this Feasibility Study, all material to be mined on the Fresnillo mineral concession is classified as waste. Delays in, or failure to obtain, the approval of COFECE for the Layback Agreement and subsequent transfer of surface rights would affect the timetable or cost of development of the potential mine modelled in this Technical Report.

The geotechnical parameters relevant to the mine plan are discussed in Section 16.2 and are adequate for this Technical Report.

Eventually, mining will be conducted below the water table, expected during Year 5 of commercial operation. Estimates of pit dewatering requirements have been prepared for cost estimation purposes. These are based on the median expected water in-flows.

16.2 Slope Angles

Several evaluations of slope angles have been conducted for Camino Rojo, all by Piteau. The slope angle design for this Technical Report is based on the report "Recommended Geotechnical

Slope Designs for the Camino Rojo “Unconstrained” Mine Plan”, dated December 18, 2019. Figure 16.1 shows the inter-ramp (IR) slope angle recommendations from that report.

The recommended slope design is based on a 38° IR angle for the post mineral rocks on the east side of the pit. The south wall is designed at a 53° IR angle based on double benching 10m benches. Lithology is dipping into the wall on the south side so it is expected to be relatively stable. It is assumed that controlled blasting, such as pre-splitting, will be required to maintain the bench face angles and catch benches.

The north and west walls are based on single benching (10m) the upper 50m of the wall at IR angles ranging from 37° to 41.5° and double benching below that at IR angles ranging from 42° to 47°. Pre-splitting is also assumed to maintain the face angles and catch benches. This is the design basis for the final pit for this Technical Report.

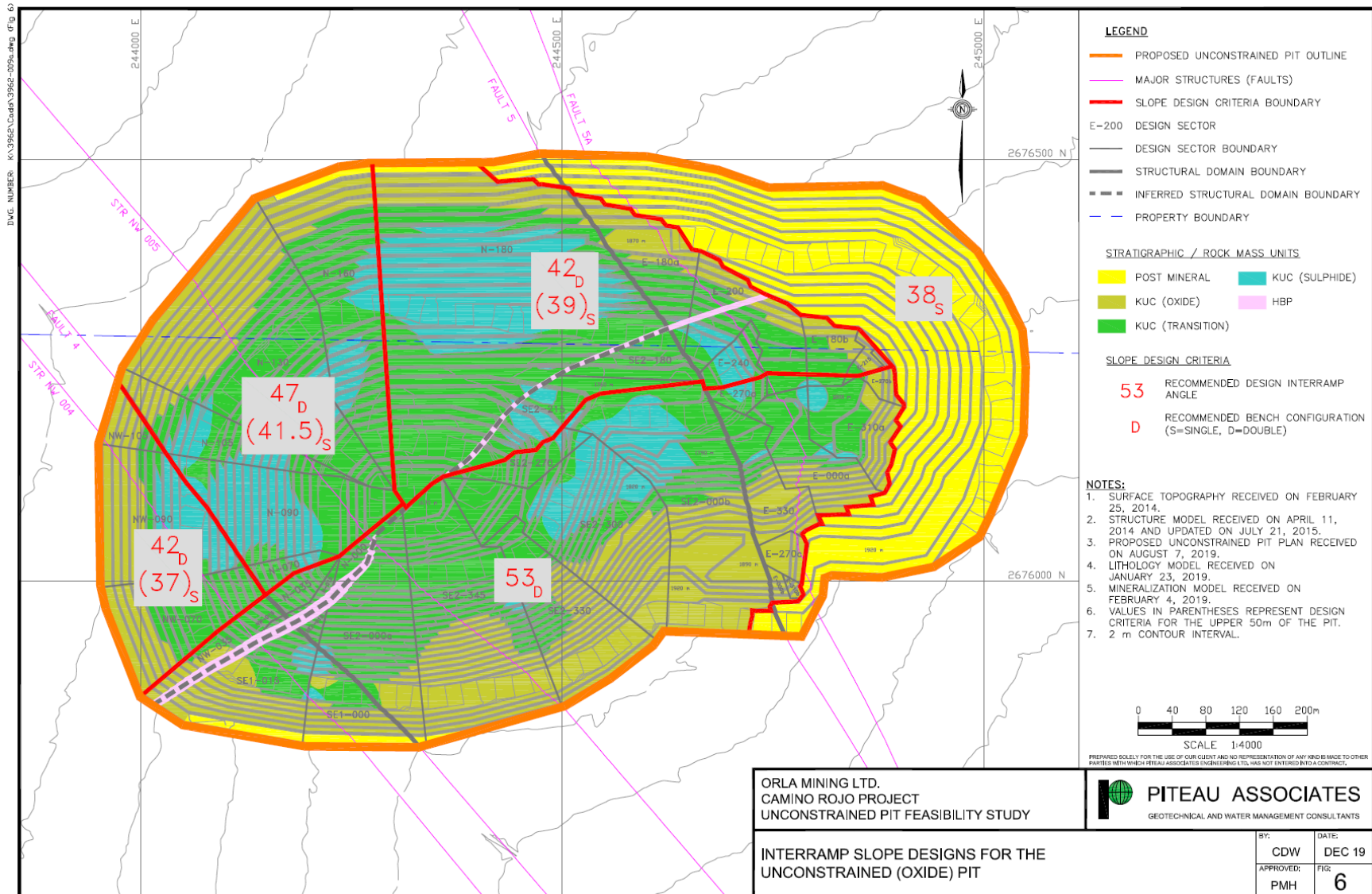

Figure 16.1 Slope Angle Recommendations, Piteau 2019

16.3 Final Pit Design

The final pit design is based on the results of a floating cone and Lerchs-Grossman analysis using the parameters discussed in the previous section. Figure 16.2 shows the final pit design. The design includes haul roads and sufficient working room for the equipment. The road is 25m wide at a maximum grade of 10%. This will accommodate trucks of approximately 100 tonne capacity such as the Caterpillar 777 class truck.

The mine plan is based on three mining phases. Figure 16.3 and Figure 16.4 show phases 1 and 2 respectively. The phase 1 starter pit targets relatively high grade Mineral Reserves in the central portion of the deposit. Phase 2 pushes the pit to final mining limits in the east and a portion of the north side. The phase 3 final pit pushes walls to final positions in the north, west, and south.

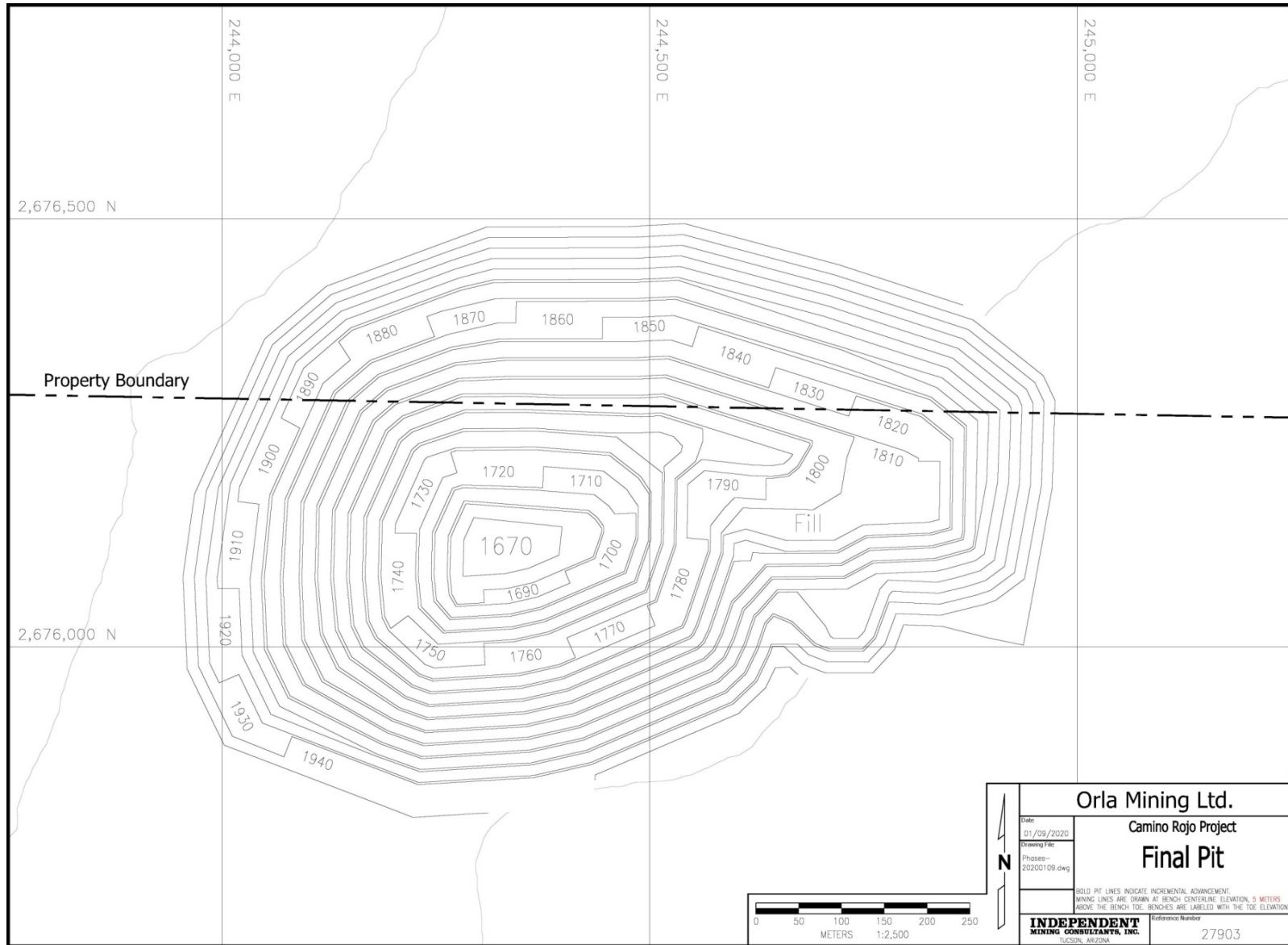

Figure 16.2 Final Pit, IMC 2019

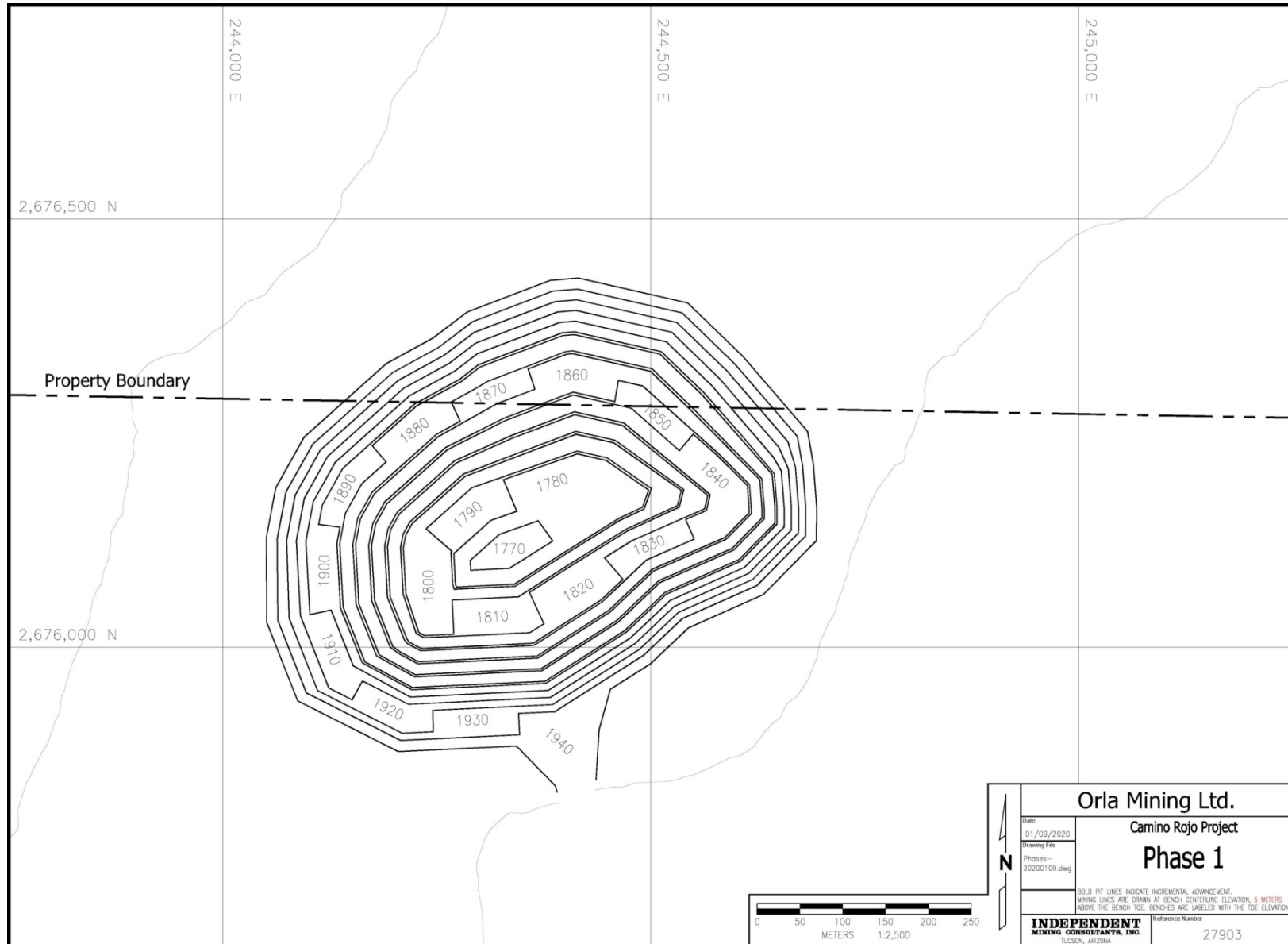

Figure 16.3 Mining Phase 1, IMC 2019

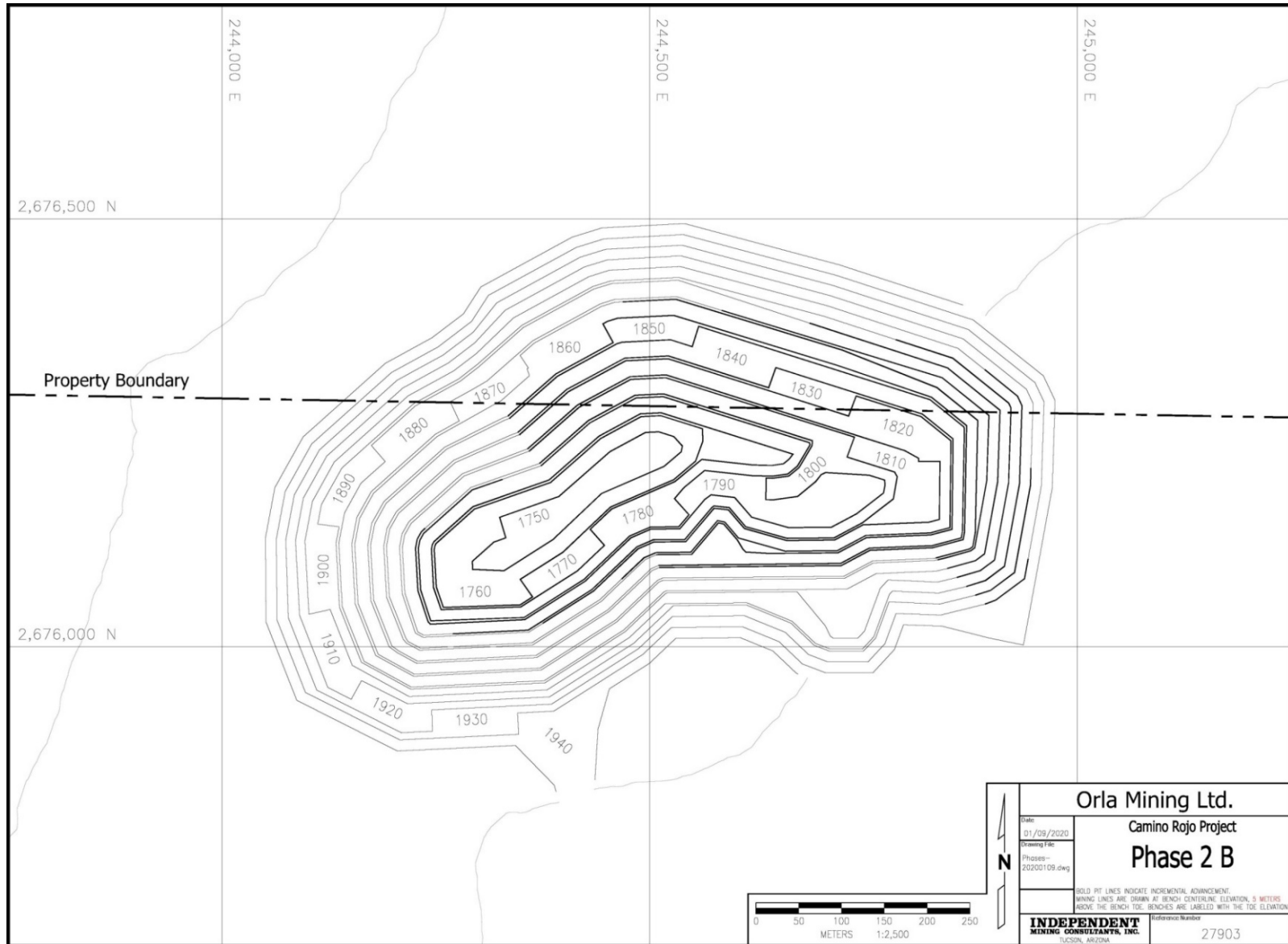

Figure 16.4 Mining Phase 2, IMC 2019

16.4 Mine Production Schedule

The schedule is based on processing the resource by crushing and heap leaching at a production rate of 18,000 tpd, or 6,570 ktpy. Table 16-1 shows the schedule. Preproduction and Year 1 are by months, Year 2 by quarters, and the rest of the schedule is by years.

The upper section of the table shows direct crusher feed material by time period. This is material that is processed during the same time period it is mined and amounts to 58.1 million tonnes at 0.80 g/t gold and 15.5 g/t silver. This produces about 1.50 million ounces of contained gold and 924,800 ounces of recoverable gold for an average recovery of 61.8%. Contained and recoverable silver amounts to 28.9 and 5.82 million ounces respectively for an average recovery of 20.1%. As discussed, due to two products, gold and silver, and different recoveries for the different material types, an NSR cut-off was used to classify Mineral Reserves and waste for scheduling. The internal NSR cut-off is US\$4.93, but this is only used for Years 8 and 9. For the other periods the cut-off varies by period to balance the mine and plant production capacities.

Ore production ramps up during the first three months of Year 1 so the plant operates at full capacity from the second quarter of Year 1 through Year 8.

Low grade is material between an NSR cut-off of US\$5.75 per tonne and the operating cut-off for the year. This amounts to 9.24 million tonnes at 0.31 g/t gold and 8.7 g/t silver. The US\$5.75 per tonne low grade stockpile cut-off is the internal cut-off of US\$4.93 per tonne and an allowance of US\$0.82 per tonne for re-handle costs.

The bottom of Table 16-1 shows that preproduction is 1 million tonnes of total material over the three-month period. Total mine production ramps up during pre-production and the first half of Year 1 and reaches the peak total material rate of 16 million tonnes per year, or 1,333kt per month, by the beginning of the third quarter of Year 1. Total material is 129.3 million tonnes. Waste, net of the low grade, is 62.0 million tonnes for an average waste strip ratio of 0.92 to 1.

Table 16-2 shows a proposed plant production schedule, including the direct feed material and the low-grade stockpile. The 84kt of ore mined during preproduction months 1 and 2 is stockpiled and becomes part of the Year 1 Month 1 plant feed. Total Year 1 Quarter 1 plant feed is 822kt, 50% of plant capacity. The 66kt of ore mined during preproduction month 3 is designated as leach pad overliner material. The low-grade stockpile material is processed during Years 8 and 9. Total processed Reserve is 67.4 million tonnes at 0.73 g/t gold and 14.5 g/t silver. This amounts to 1.59 million ounces of contained gold and 31.5 million ounces of contained silver respectively. Recoverable gold and silver are 979,800 ounces and 6.19 million ounces respectively for average recoveries of 62% for gold and 20% for silver. The commercial Project life, including the low-grade stockpile, is about 10½ years.

Table 16-3 shows the proposed plant schedule by material type.

Figure 16.5 through Figure 16.16 show the pit, waste storage, and low-grade stockpile at the end of each mining year. Open pit mining is completed near the end of Year 9. Capping and reclamation of the waste storage facility is completed during Year 10, and the low-grade stockpile is reclaimed and processed by the middle of Year 11.

The mine production schedule includes allowances for mining dilution and ore loss. IMC believes that reasonable amounts of dilution and loss were incorporated into the block model used for this Technical Report. Compositing assays into composites and estimating blocks with multiple composites introduces some smoothing of model grades that are analogous to dilution and ore loss effects.

Only Measured and Indicated Mineral Resource are included in this schedule and converted to Mineral Reserves. Inferred Mineral Resource in the pit, above the annual NSR cutoffs, is 574 kt, but is treated as waste for this Technical Report.

Table 16-1
Mine Production Schedule - 6,570 KTPY

MINE PRODUCTION SCHEDULE:	(Units)	TOTAL	PP M1	PP M2	PP M3	Yr1 M1	Yr1 M2	Yr1 M3	Yr1 M4	Yr1 M5	Yr1 M6	Yr1 M7	Yr1 M8	Yr1 M9	Yr1 M10	Yr1 M11	Yr1 M12	Yr2 Q1	Yr2 Q2	Yr2 Q3	Yr2 Q4	Year 3	Year 4	Year 5	Year 6	Year 7	Year 8	Year 9	
LEACH RESOURCE:																													
NSR Cutoff	(\$/t)		7.00	7.00	7.00	7.00	7.00	7.00	9.75	9.75	9.75	9.50	9.50	9.50	11.00	11.00	11.00	12.00	11.50	11.50	11.25	10.00	9.00	8.50	8.50	7.00	4.93	4.93	
Ktonnes	(kt)	58,120	54	30	66	140	160	438	547	547	549	547	548	548	547	549	547	1,642	1,641	1,643	1,643	6,571	6,571	6,570	6,571	6,569	6,571	6,311	
NSR	(\$/t)	20.86	23.91	23.91	11.48	19.00	26.49	25.15	17.50	21.46	27.09	22.16	19.08	27.87	25.48	24.27	21.32	22.93	25.71	26.72	25.55	24.09	25.02	23.08	19.39	16.20	15.14	16.75	
Gold	(g/t)	0.801	0.852	0.852	0.502	0.739	0.983	0.915	0.618	0.779	1.002	0.800	0.700	1.032	0.934	0.882	0.762	0.820	0.927	0.972	0.918	0.864	0.903	0.865	0.765	0.661	0.668	0.736	
Silver	(g/t)	15.48	11.07	11.07	6.81	8.18	9.33	10.76	11.32	10.84	10.76	10.72	9.60	9.93	10.89	9.82	11.71	12.67	11.50	12.36	12.79	13.94	16.81	17.56	17.87	16.49	15.25	18.06	
Lead	(%)	0.262	0.431	0.431	0.099	0.200	0.340	0.357	0.385	0.304	0.367	0.251	0.267	0.319	0.302	0.325	0.321	0.325	0.317	0.331	0.316	0.289	0.307	0.288	0.283	0.210	0.151	0.201	
Zinc	(%)	0.408	0.346	0.346	0.195	0.240	0.270	0.289	0.366	0.315	0.279	0.235	0.278	0.265	0.261	0.264	0.382	0.350	0.302	0.351	0.327	0.342	0.388	0.485	0.424	0.448	0.418	0.539	
Arsenic	(ppm)	700	1,326	1,326	562	769	974	960	958	843	945	688	807	969	797	908	727	768	882	833	896	757	748	660	617	621	559	645	
Sulfur	(%)	0.660	0.431	0.431	1.364	0.387	0.540	0.493	0.309	0.310	0.443	0.232	0.273	0.368	0.247	0.334	0.210	0.207	0.213	0.181	0.190	0.174	0.426	0.624	0.709	1.069	1.132	1.257	
Recovered Gold	(g/t)	0.495	0.596	0.596	0.281	0.473	0.664	0.628	0.432	0.534	0.677	0.552	0.474	0.698	0.635	0.607	0.529	0.569	0.642	0.666	0.636	0.596	0.609	0.547	0.451	0.363	0.332	0.359	
Recovered Silver	(g/t)	3.11	1.22	1.22	1.02	1.05	1.08	1.23	1.25	1.22	1.26	1.21	1.12	1.18	1.28	1.12	1.30	1.41	1.29	1.40	1.42	1.58	2.45	3.47	3.65	4.14	4.42	5.60	
Contained Gold	(koz)	1,496.7	1.5	0.8	1.1	3.3	5.1	12.9	10.9	13.7	17.7	14.1	12.3	18.2	16.4	15.6	13.4	43.3	48.9	51.3	48.5	182.5	190.9	182.7	161.7	139.6	141.1	149.4	
Recoverable Gold	(koz)	924.8	1.0	0.6	0.6	2.1	3.4	8.8	7.6	9.4	12.0	9.7	8.4	12.3	11.2	10.7	9.3	30.1	33.9	35.2	33.6	126.0	128.7	115.6	95.2	76.6	70.2	72.8	
Contained Silver	(koz)	28,918	19	11	14	37	48	152	199	191	190	188	169	175	192	173	206	669	606	653	676	2,945	3,551	3,709	3,776	3,482	3,223	3,664	
Recoverable Silver	(koz)	5,820	2	1	2	5	6	17	22	21	22	21	20	21	22	20	23	74	68	74	75	333	519	734	772	875	934	1,137	
Gold Recovery	(%)	61.8%	70.0%	70.0%	56.0%	64.0%	67.5%	68.6%	69.9%	68.5%	67.6%	69.0%	67.7%	67.7%	68.0%	68.8%	69.4%	69.4%	69.2%	68.5%	69.3%	69.0%	67.4%	63.3%	58.9%	54.9%	49.8%	48.7%	
Silver Recovery	(%)	20.1%	11.0%	11.0%	15.0%	12.8%	11.5%	11.4%	11.1%	11.3%	11.7%	11.3%	11.6%	11.9%	11.7%	11.4%	11.1%	11.1%	11.2%	11.3%	11.1%	11.3%	14.6%	19.8%	20.5%	25.1%	29.0%	31.0%	
LOW GRADE STOCKPILE:																													
NSR Cutoff	(\$/t)		5.75	5.75	5.75	5.75	5.75	5.75	5.75	5.75	5.75	5.75	5.75	5.75	5.75	5.75	5.75	5.75	5.75	5.75	5.75	5.75	5.75	5.75	5.75	5.75	5.75	5.75	5.75
Ktonnes	(kt)	9,243	0	0	18	3	0	19	361	58	84	55	153	168	243	341	118	1,018	686	436	539	1,185	998	785	1,424	551	0	0	
NSR	(\$/t)	7.83	0.00	0.00	6.49	6.45	0.00	6.41	8.11	8.63	8.19	7.56	7.80	7.59	8.38	8.23	9.17	9.21	8.67	8.45	8.23	7.94	7.24	7.04	7.07	6.39	0.00	0.00	
Gold	(g/t)	0.308	0.000	0.000	0.276	0.275	0.000	0.249	0.292	0.319	0.293	0.309	0.305	0.323	0.355	0.312	0.330	0.342	0.332	0.337	0.313	0.310	0.296	0.283	0.293	0.268	0.000	0.000	
Silver	(g/t)	8.71	0.00	0.00	6.06	5.95	0.00	7.85	9.72	10.20	9.90	7.63	7.64	6.16	7.03	8.99	10.23	9.47	8.77	7.99	9.88	9.19	8.31	7.78	8.67	8.32	0.00	0.00	
Lead	(%)	0.170	0.000	0.000	0.064	0.069	0.000	0.183	0.317	0.179	0.263	0.106	0.115	0.083	0.103	0.236	0.236	0.241	0.187	0.162	0.179	0.162	0.151	0.149	0.140	0.096	0.000	0.000	
Zinc	(%)	0.245	0.000	0.000	0.186	0.170	0.000	0.188	0.309	0.297	0.288	0.187	0.192	0.190	0.209	0.307	0.329	0.275	0.270	0.241	0.247	0.241	0.237	0.216	0.237	0.199	0.000	0.000	
Arsenic	(ppm)	477	0	0	393	459	0	567	782	425	497	439	540	432	483	651	567	572	519	460	514	473	409	378	383	409	0	0	
Sulfur	(%)	0.177	0.000	0.000	0.896	0.519	0.000	0.157	0.300	0.113	0.104	0.062	0.363	0.107	0.097	0.168	0.186	0.169	0.099	0.093	0.080	0.090	0.159	0.079	0.327	0.349	0.000	0.000	
Recovered Gold	(g/t)	0.185	0.000	0.000	0.155	0.154	0.000	0.151	0.193	0.206	0.195	0.180	0.187	0.183	0.202	0.197	0.219	0.221	0.208	0.203	0.195	0.188	0.170	0.167	0.161	0.145	0.000	0.000	
Recovered Silver	(g/t)	1.24	0.00	0.00	0.91	0.89	0.00	1.05	1.15	1.23	1.17	1.07	1.01	0.91	1.03	1.09	1.19	1.14	1.10	1.06	1.26	1.21	1.22	1.11	1.62	1.49	0.00	0.00	
Contained Gold	(koz)	91.6	0.0	0.0	0.2	0.0	0.0	0.2	3.4	0.6	0.8	0.5	1.5	1.7	2.8	3.4	1.3	11.2	7.3	4.7	5.4	11.8	9.5	7.2	13.4	4.7	0.0	0.0	
Recoverable Gold	(koz)	54.9	0.0	0.0	0.1	0.0	0.0	0.1	2.2	0.4	0.5	0.3	0.9	1.0	1.6	2.2	0.8	7.2	4.6	2.8	3.4	7.2	5.4	4.2	7.3	2.6	0.0	0.0	
Contained Silver	(koz)	2,588	0	0	4	1	0	5	113	19	27	13	38	33	55	99	39	310	193	112	171	350	267	196	397	147	0	0	
Recoverable Silver	(koz)	368	0	0	1	0	0	1	13	2	3	2	5	5	8	12	5	37	24	15	22	46	39	28	74	26	0	0	
Gold Recovery	(%)	60.0%	0.0%	0.0%	56.2%	56.0%	0.0%	60.6%	66.1%	64.4%	66.5%	58.2%	61.3%	56.7%	56.9%	63.1%	66.5%	64.8%	62.5%	60.1%	62.3%	60.8%	57.5%	58.8%	54.9%	54.2%	0.0%	0.0%	
Silver Recovery	(%)	14.2%	0.0%	0.0%	15.0%	15.0%	0.0%	13.4%	11.8%	12.1%	11.8%	14.0%	13.3%	14.8%	14.7%	12.2%	11.7%	12.0%	12.6%	13.3%	12.7%	13.1%	14.7%	14.2%	18.7%	18.0%	0.0%	0.0%	
TOTAL MATERIAL AND WASTE:																													
Total Material	(kt)	129,338	200	300	515	508	501	1,000	1,000	1,000	1,002	1,333	1,331	1,334	1,333	1,333	1,334	4,000	3,999	4,000	4,000	16,002	15,999	15,999	15,971	15,528	11,430	8,386	
Waste (Net of Low Grade)	(kt)	61,975	146	270	431	365	341	543	92	395	369	731	630	618	543	443	669	1,340	1,672	1,921	1,818	8,246	8,430	8,644	7,976	8,408	4,859	2,075	
Waste Ratio	(none)	0.92	2.70	9.00	5.13	2.55	2.13	1.19	0.10	0.65	0.58	1.21	0.90	0.86	0.69	0.50	1.01	0.50	0.72	0.92	0.83	1.06	1.11	1.18	1.00	1.18	0.74	0.33	

**Table 16-2
Proposed Plant Production Schedule - 6,570 KTPY**

PLANT PRODUCTION SCHEDULE:	(Units)	TOTAL	PP M1	PP M2	PP M3	Yr1 M1	Yr1 M2	Yr1 M3	Yr1 M4	Yr1 M5	Yr1 M6	Yr1 M7	Yr1 M8	Yr1 M9	Yr1 M10	Yr1 M11	Yr1 M12	Yr2 Q1	Yr2 Q2	Yr2 Q3	Yr2 Q4	Year 3	Year 4	Year 5	Year 6	Year 7	Year 8	Year 9	Year 10	Year 11
LEACH RESOURCE:			Ov Liner																											
NSR Cutoff	(\$/t)		7.00	7.00	7.00	7.00	7.00	7.00	9.75	9.75	9.75	9.50	9.50	9.50	11.00	11.00	11.00	12.00	11.50	11.50	11.25	10.00	9.00	8.50	8.50	7.00	4.93	4.93	4.93	4.93
Ktonnes	(kt)	67,363	0	0	66	224	160	438	547	547	549	547	548	548	547	549	547	1,642	1,641	1,643	1,643	6,571	6,571	6,570	6,571	6,569	6,571	6,570	6,570	2,414
NSR	(\$/t)	19.08	0.00	0.00	11.48	20.84	26.49	25.15	17.50	21.46	27.09	22.16	19.08	27.87	25.48	24.27	21.32	22.93	25.71	26.72	25.55	24.09	25.02	23.08	19.39	16.20	15.14	16.34	7.62	8.57
Gold	(g/t)	0.733	0.000	0.000	0.502	0.781	0.983	0.915	0.618	0.779	1.002	0.800	0.700	1.032	0.934	0.882	0.762	0.820	0.927	0.972	0.918	0.864	0.903	0.865	0.765	0.661	0.668	0.719	0.304	0.322
Silver	(g/t)	14.55	0.00	0.00	6.81	9.26	9.33	10.76	11.32	10.84	10.76	10.72	9.60	9.93	10.89	9.82	11.71	12.67	11.50	12.36	12.79	13.94	16.81	17.56	17.87	16.49	15.25	17.63	8.64	9.07
Lead	(%)	0.250	0.000	0.000	0.099	0.286	0.340	0.357	0.385	0.304	0.367	0.251	0.267	0.319	0.302	0.325	0.321	0.325	0.317	0.331	0.316	0.289	0.307	0.288	0.283	0.210	0.151	0.196	0.153	0.228
Zinc	(%)	0.386	0.000	0.000	0.195	0.279	0.270	0.289	0.366	0.315	0.279	0.235	0.278	0.265	0.261	0.264	0.382	0.350	0.302	0.351	0.327	0.342	0.388	0.485	0.424	0.448	0.418	0.525	0.237	0.274
Arsenic	(ppm)	669	0	0	562	978	974	960	958	843	945	688	807	969	797	908	727	768	882	833	896	757	748	660	617	621	559	635	435	600
Sulfur	(%)	0.594	0.000	0.000	1.364	0.404	0.540	0.493	0.309	0.310	0.443	0.232	0.273	0.368	0.247	0.334	0.210	0.207	0.213	0.181	0.190	0.174	0.426	0.624	0.709	1.069	1.132	1.230	0.152	0.202
Recovered Gold	(g/t)	0.452	0.000	0.000	0.281	0.519	0.664	0.628	0.432	0.534	0.677	0.552	0.474	0.698	0.635	0.607	0.529	0.569	0.642	0.666	0.636	0.596	0.609	0.547	0.451	0.363	0.332	0.350	0.179	0.205
Recovered Silver	(g/t)	2.86	0.00	0.00	1.02	1.11	1.08	1.23	1.25	1.22	1.26	1.21	1.12	1.18	1.28	1.12	1.30	1.41	1.29	1.40	1.42	1.58	2.45	3.47	3.65	4.14	4.42	5.45	1.26	1.11
Contained Gold	(koz)	1,588.3	0.0	0.0	1.1	5.6	5.1	12.9	10.9	13.7	17.7	14.1	12.3	18.2	16.4	15.6	13.4	43.3	48.9	51.3	48.5	182.5	190.9	182.7	161.7	139.6	141.1	151.8	64.2	25.0
Recoverable Gold	(koz)	979.8	0.0	0.0	0.6	3.7	3.4	8.8	7.6	9.4	12.0	9.7	8.4	12.3	11.2	10.7	9.3	30.1	33.9	35.2	33.6	126.0	128.7	115.6	95.2	76.6	70.2	73.9	37.8	15.9
Contained Silver	(koz)	31,506	0	0	14	67	48	152	199	191	190	188	169	175	192	173	206	669	606	653	676	2,945	3,551	3,709	3,776	3,482	3,223	3,724	1,824	704
Recoverable Silver	(koz)	6,189	0	0	2	8	6	17	22	21	22	21	20	21	22	20	23	74	68	74	75	333	519	734	772	875	934	1,152	267	86
Gold Recovery	(%)	61.7%	0.0%	0.0%	56.0%	66.5%	67.5%	68.6%	69.9%	68.5%	67.6%	69.0%	67.7%	67.7%	68.0%	68.8%	69.4%	69.4%	69.2%	68.5%	69.3%	69.0%	67.4%	63.3%	58.9%	54.9%	49.8%	48.7%	58.9%	63.9%
Silver Recovery	(%)	19.6%	0.0%	0.0%	15.0%	12.0%	11.5%	11.4%	11.1%	11.3%	11.7%	11.3%	11.6%	11.9%	11.7%	11.4%	11.1%	11.1%	11.2%	11.3%	11.1%	11.3%	14.6%	19.8%	20.5%	25.1%	29.0%	30.9%	14.6%	12.2%

16.5 Waste Storage Area and Stockpile

A waste rock storage area was designed southeast of the pit to hold the waste rock for the pit. Table 16-4 shows a summary of total mine waste by waste type. Waste for each combination of lithology (post mineral or Caracol), alteration type (Kp, Ki, or none), and oxidation type is shown. The lead, zinc, arsenic, and sulphur grades are also reported by waste type.

Table 16-4
Mine Waste by Material Type

Waste Type	Waste Ktonnes	Lead (%)	Zinc (%)	Arsenic (ppm)	Sulfur (%)
Post Mineral:	13,875	0.01	0.02	39	0.049
Caracol Kp Oxide:	4,626	0.18	0.23	482	0.080
Caracol Kp TrH:	329	0.16	0.29	458	0.972
Caracol Kp TrL:	1,020	0.15	0.21	460	0.933
Caracol Kp TrS:	3,384	0.16	0.46	542	2.525
Caracol Kp Slf:	1,626	0.19	0.60	589	4.361
Caracol Ki Oxide:	19,239	0.04	0.12	215	0.080
Caracol Ki TrH:	410	0.03	0.10	281	0.193
Caracol Ki TrL:	4,575	0.03	0.08	239	0.483
Caracol Ki TrS:	2,181	0.04	0.09	245	0.838
Caracol Ki Slf:	1,180	0.04	0.07	247	0.826
Caracol None Oxide:	7,553	0.02	0.06	122	0.067
Caracol None TrH:	75	0.01	0.06	128	0.181
Caracol None TrL:	790	0.02	0.07	123	0.278
Caracol None TrS:	1,063	0.02	0.08	122	0.783
Caracol None Slf:	46	0.01	0.04	73	0.724
TOTAL:	61,972	0.05	0.12	218	0.423

Guidance for the design of the waste storage area was provided by HydroGeoLogica in the memo report “Camino Rojo – Waste Rock Management Plan” dated 22 January 2020 as summarized herein. It was recommended that transition and sulphide material be blended with, or encapsulated by, post mineral or oxide materials. It is expected that this will provide excess neutralization potential (NP) for neutralization of localized acidic conditions in the waste storage facility. It was also recommended a minimum of 5m of post mineral or oxide waste be developed as a base layer prior to placement of transition and sulphide waste and also that transition or sulphide waste be encapsulated with a minimum of 3m of post mineral or oxide waste on top or on the side slopes of the facility. The current design exceeds this amount on the side slopes to allow some contouring of the facility during closure without exposing the transition and sulphide waste.

Total waste amounts to 62.0 million tonnes. Of this, about 16.7 million tonnes is transition or sulphide material to be encapsulated. Average in-situ bulk density of the waste is estimated at 2.35 tonnes per cubic metre. The waste storage design assumes 30% swell, so average density of the placed waste is about 1.81 tonnes per cubic metre.

Preproduction and Year 1 produce 6.6 million tonnes of waste, and none of the waste is transition or sulphide material. This is shown in Figure 16.6. The main part of the facility is raised to the 1930 level.

Year 2 produces about 6.7 million tonnes of waste, all oxide except 34 kt of which are transition or sulphide material. The facility is extended to the southeast for the 1930 lift and a 1945 lift has been started. The small amount of transition/sulphide waste is also shown in Figure 16.7.

Year 3 produces 8.2 million tonnes of waste of which 315 kt are transition or sulphide material. All the waste is placed on the 1945 lift. A hole is being developed in the centre of the facility to contain the transition/sulphide waste, as shown in Figure 16.8.

Year 4 produces 8.4 million tonnes of waste of which only 75 kt are transition or sulphide material. Figure 16.9 shows placement of the transition and sulphide material in the hole. Clean waste is used to complete the 1945 lift and start a 1960 lift.

Year 5 produces 8.6 million tonnes of waste of which 1.1 million tonnes are transition or sulphide material. Figure 16.10 shows the sulphide placed in the centre of the facility on the 1945 lift. The oxide waste is stacked around it on the 1960 lift.

Year 6 produces 8.0 million tonnes of waste of which 2.9 million tonnes are transition or sulphide material. The transition/sulphide waste is still being placed in the hole on the 1945 lift. Clean waste is used to raise the facility to the 1975 lift in the northwest as shown on Figure 16.11.

Year 7 produces 8.4 million tonnes of waste of which 5.6 million tonnes are transition or sulphide material. The transition/sulphide waste is placed in the hole, raising it to the 1960 level. Clean waste is placed on the 1975 lift as shown in Figure 16.12.

Year 8 produces 4.9 million tonnes of waste of which 4.6 million tonnes are transition or sulphide material. Transition/sulphide waste is raised to the 1975 lift in the centre of the facility as shown in Figure 16.13.

Year 9 produces 2.1 million tonnes of waste, all of which is transition or sulphide material. This is placed on the 1975 lift as shown in Figure 16.14. This figure shows the pit and waste storage at the end of mining.

During Year 10, at the end of mining, about 2.8 million tonnes will be re-handled to cap the transition and sulphide material. Figure 16.15 shows the final waste storage facility with the transition and sulphide waste encapsulated.

The stability of the waste storage facility was analysed by Piteau. This is documented in the memo report “Geotechnical Review of the Waste Dump and Heap Leach Pad Designs Associated with the “Unconstrained” Mine Plan” dated 2 March 2020 as summarized herein. It was concluded that there are no short term or long-term risks of significant instability for the facility.

The mine plan also produces about 9.2 million tonnes of low-grade material that will be stockpiled and processed at the end of commercial pit production. The stockpiled material will be processed beginning in Year 9 and will be completely processed and reclaimed about half way through Year 11. See Figure 16.16. The development and reclamation of the stockpile is also shown on the various figures.



Figure 16.5 End of Preproduction, IMC 2019

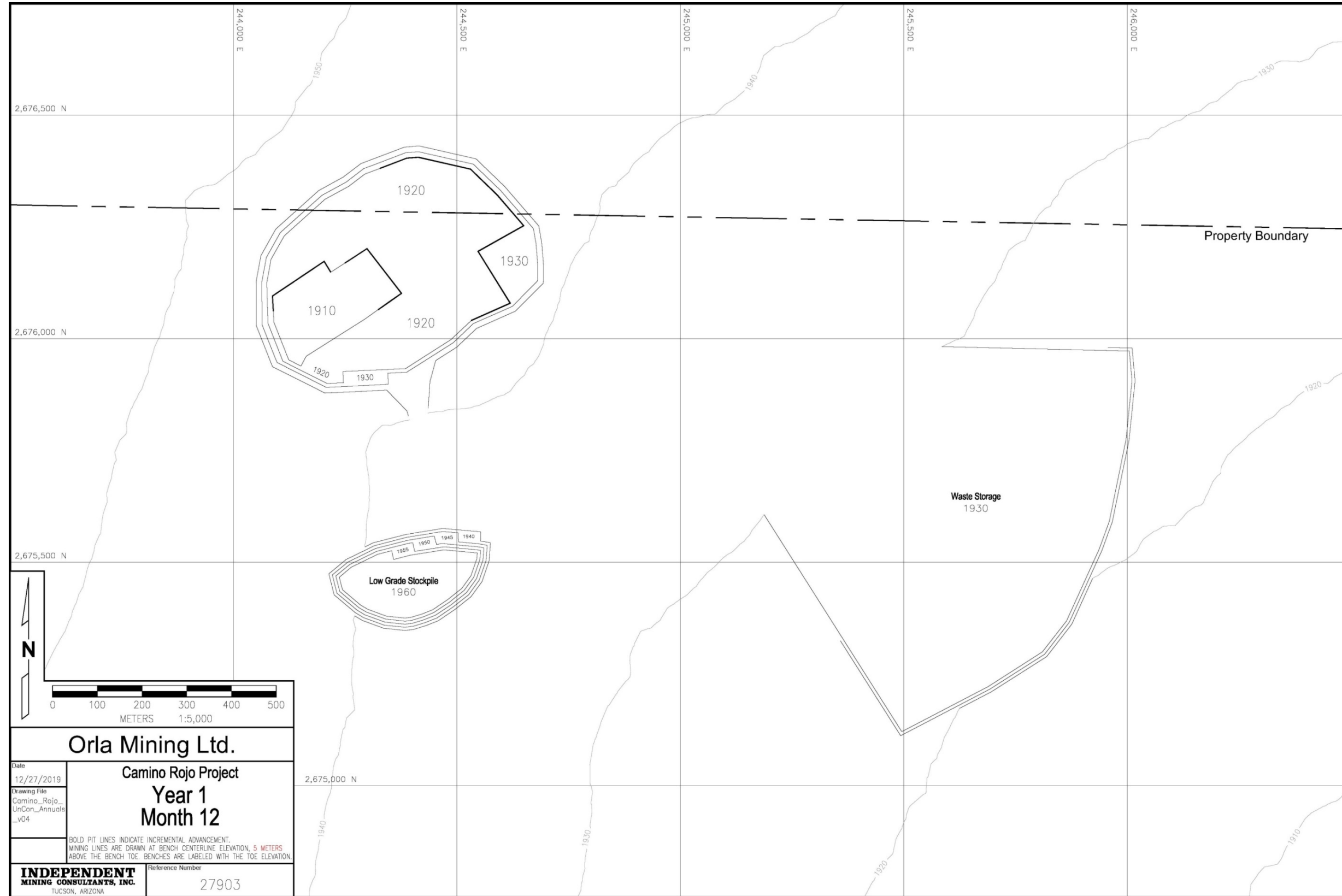

Figure 16.6 End of Year 1, IMC 2019

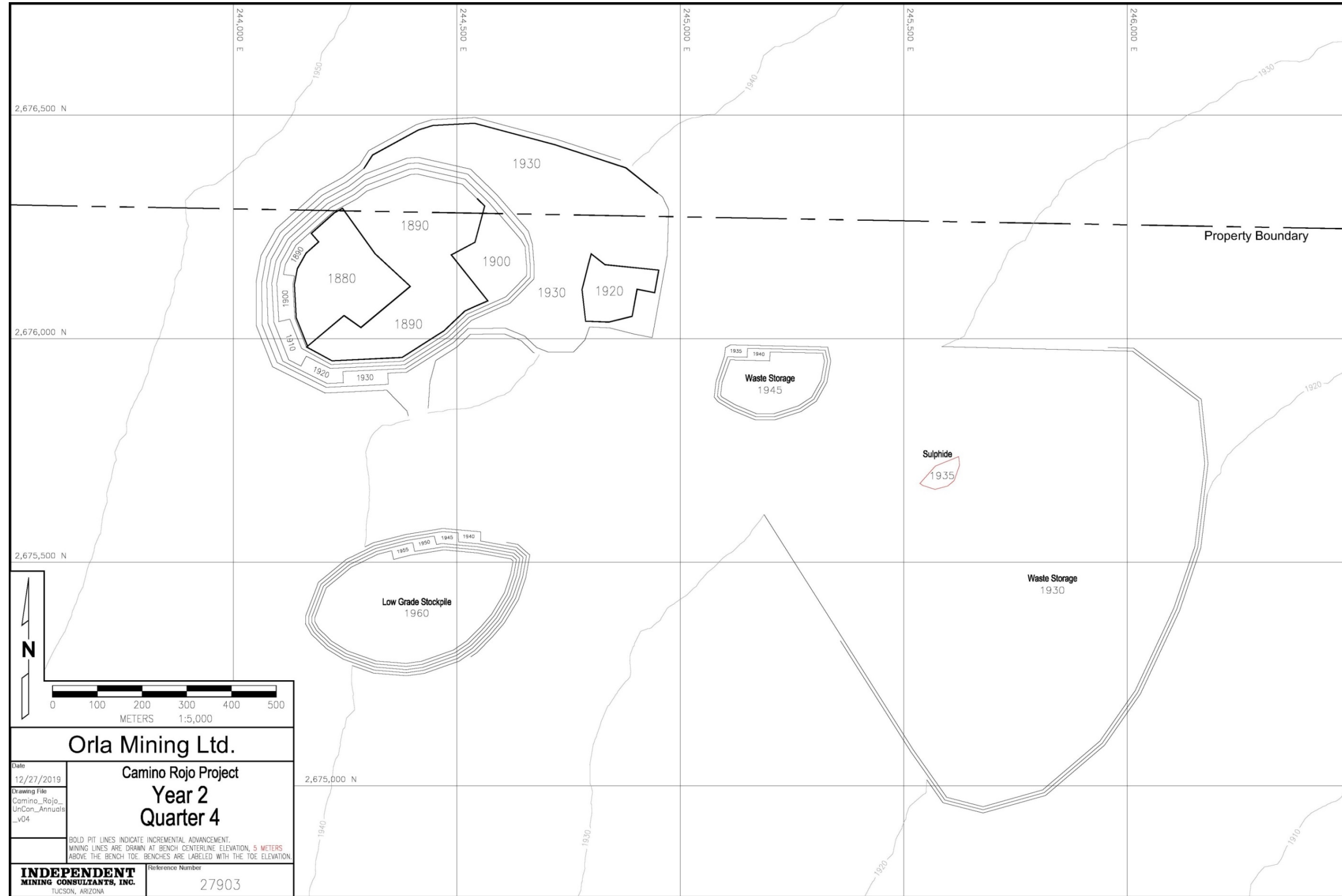

Figure 16.7 End of Year 2, IMC 2019



Figure 16.8 End of Year 3, IMC 2019

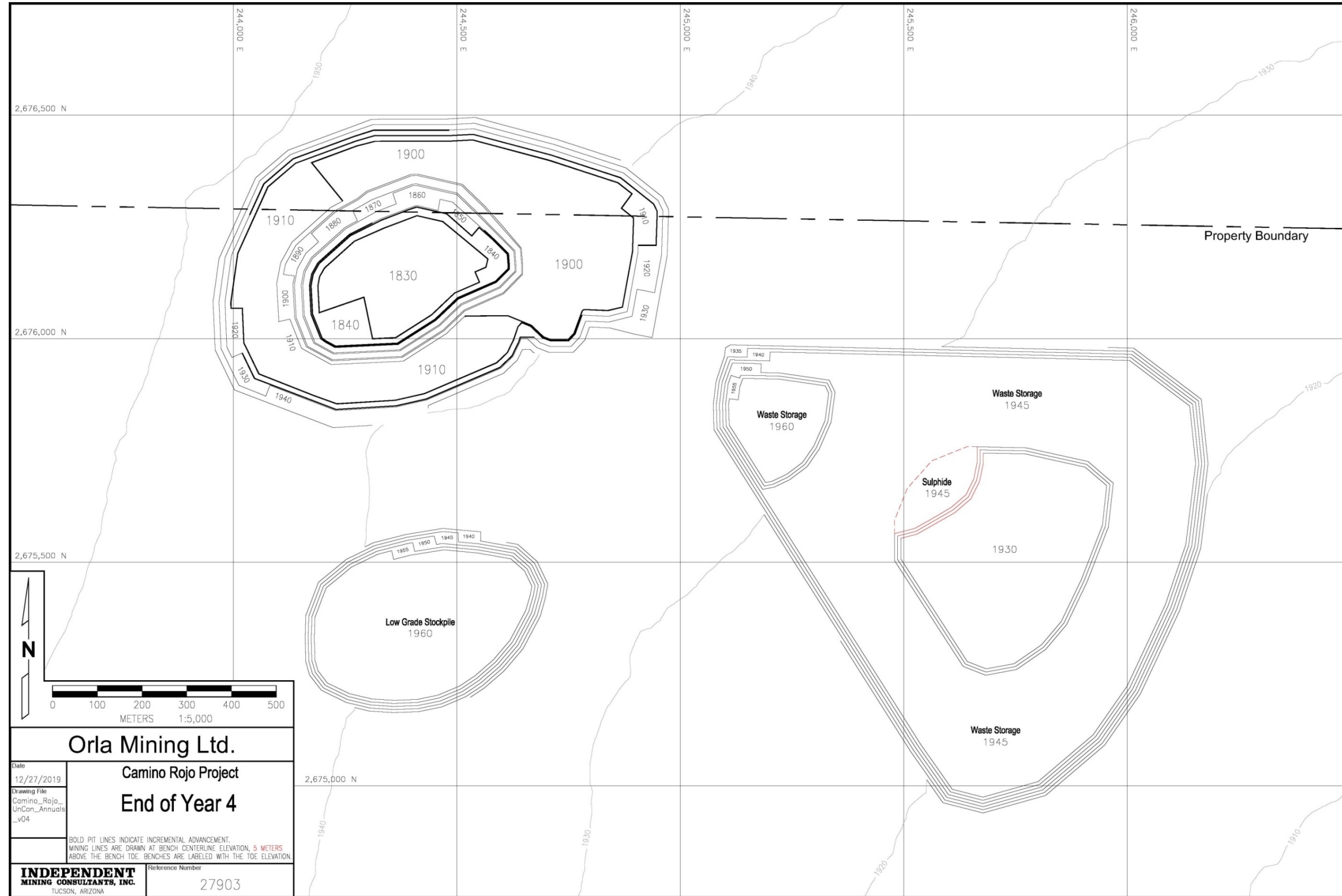

Figure 16.9 End of Year 4, IMC 2019



Figure 16.10 End of Year 5, IMC 2019



Figure 16.11 End of Year 6, IMC 2019

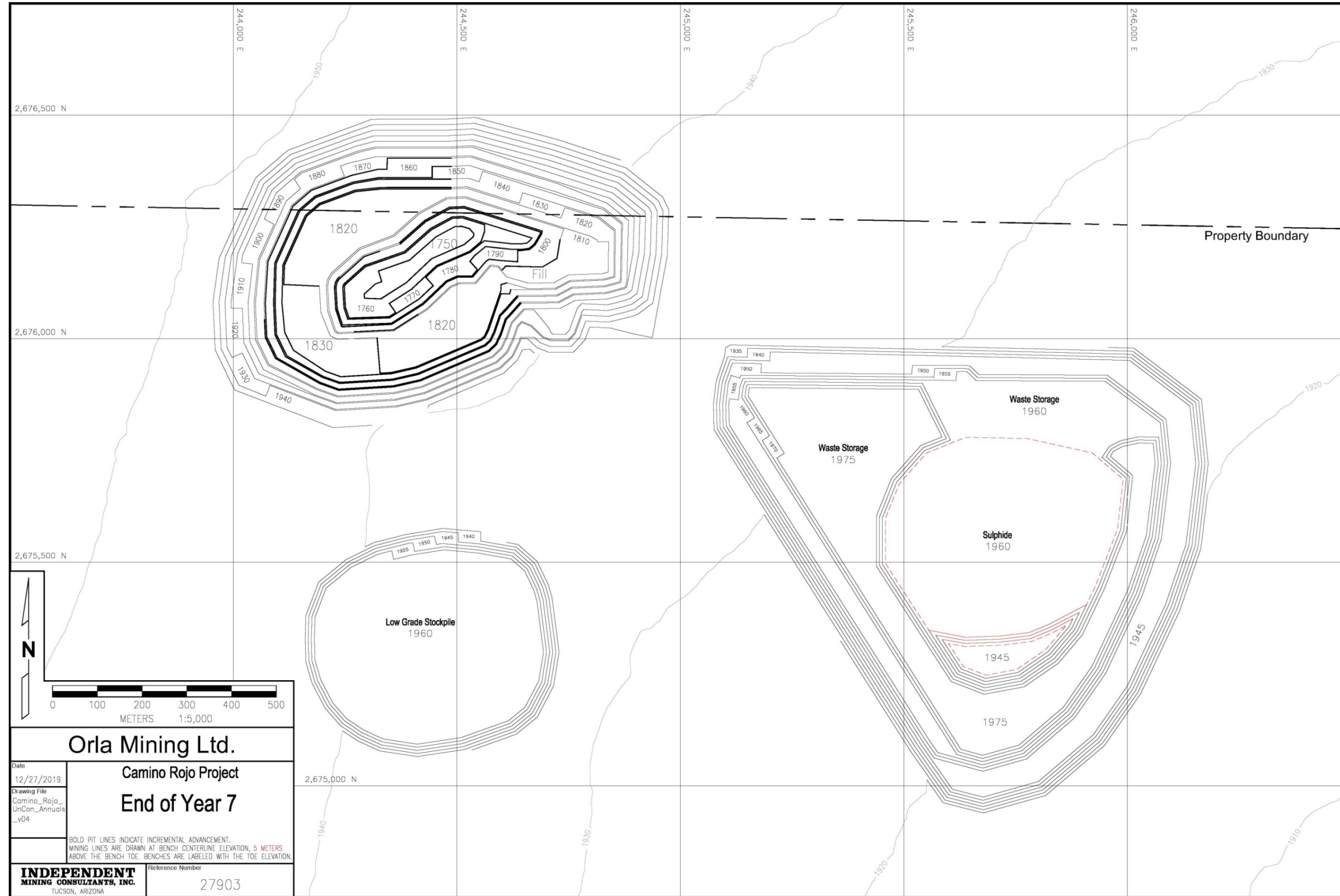

Figure 16.12 End of Year 7, IMC 2019

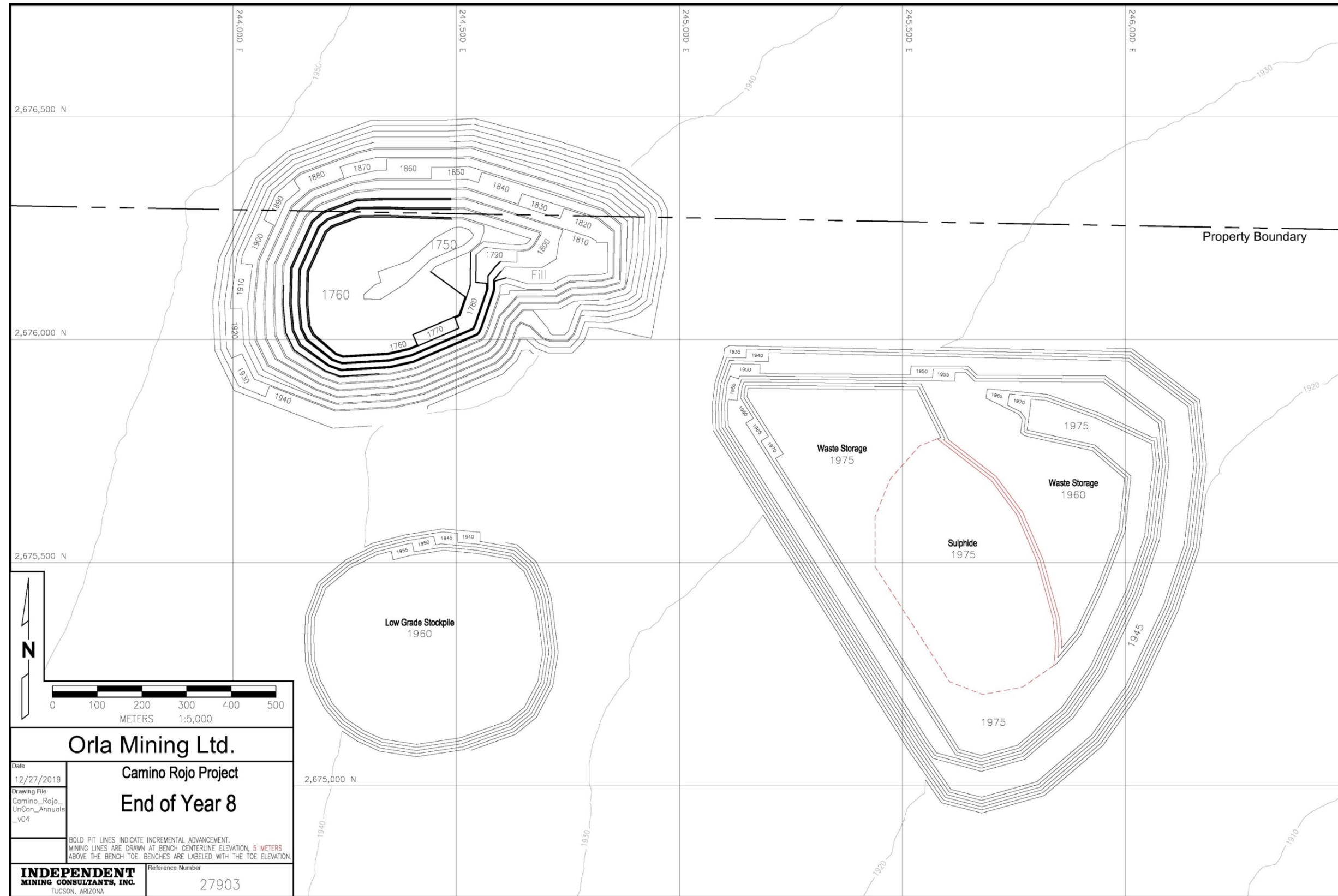

Figure 16.13 End of Year 8 2019

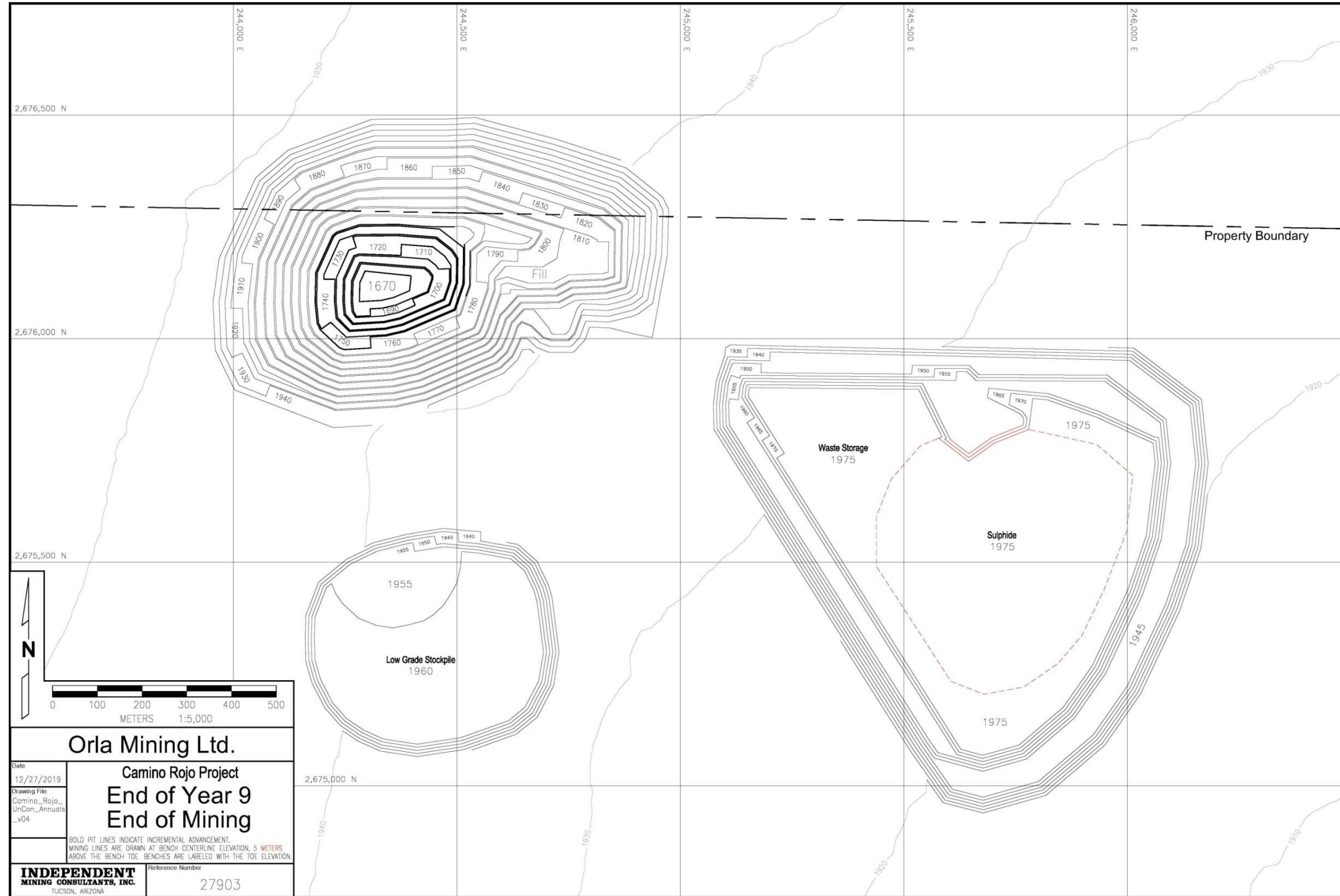

Figure 16.14 Year 9 – End of Mining, IMC 2019

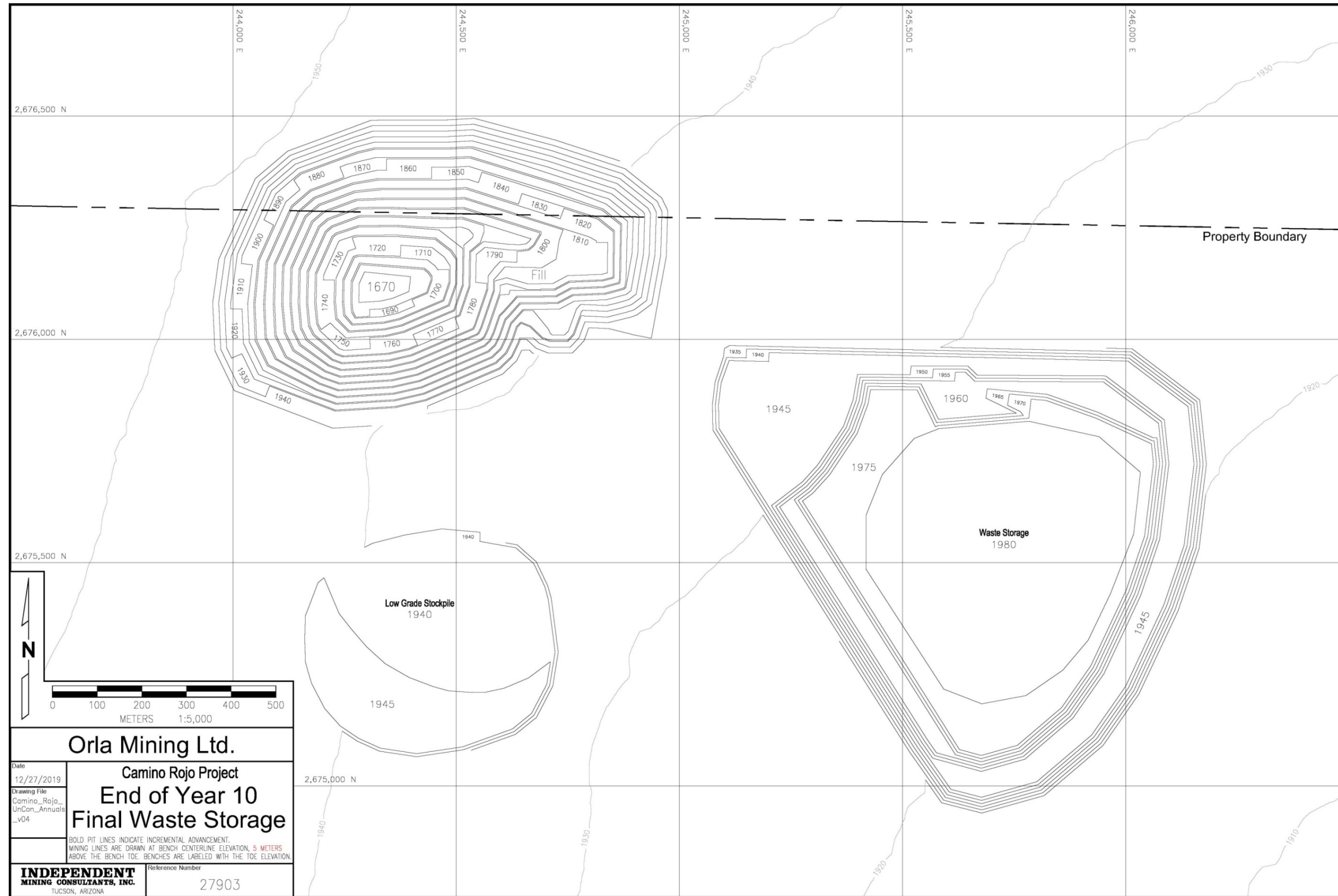

Figure 16.15 Year 10 – End of Waste Storage Capping, IMC 2019

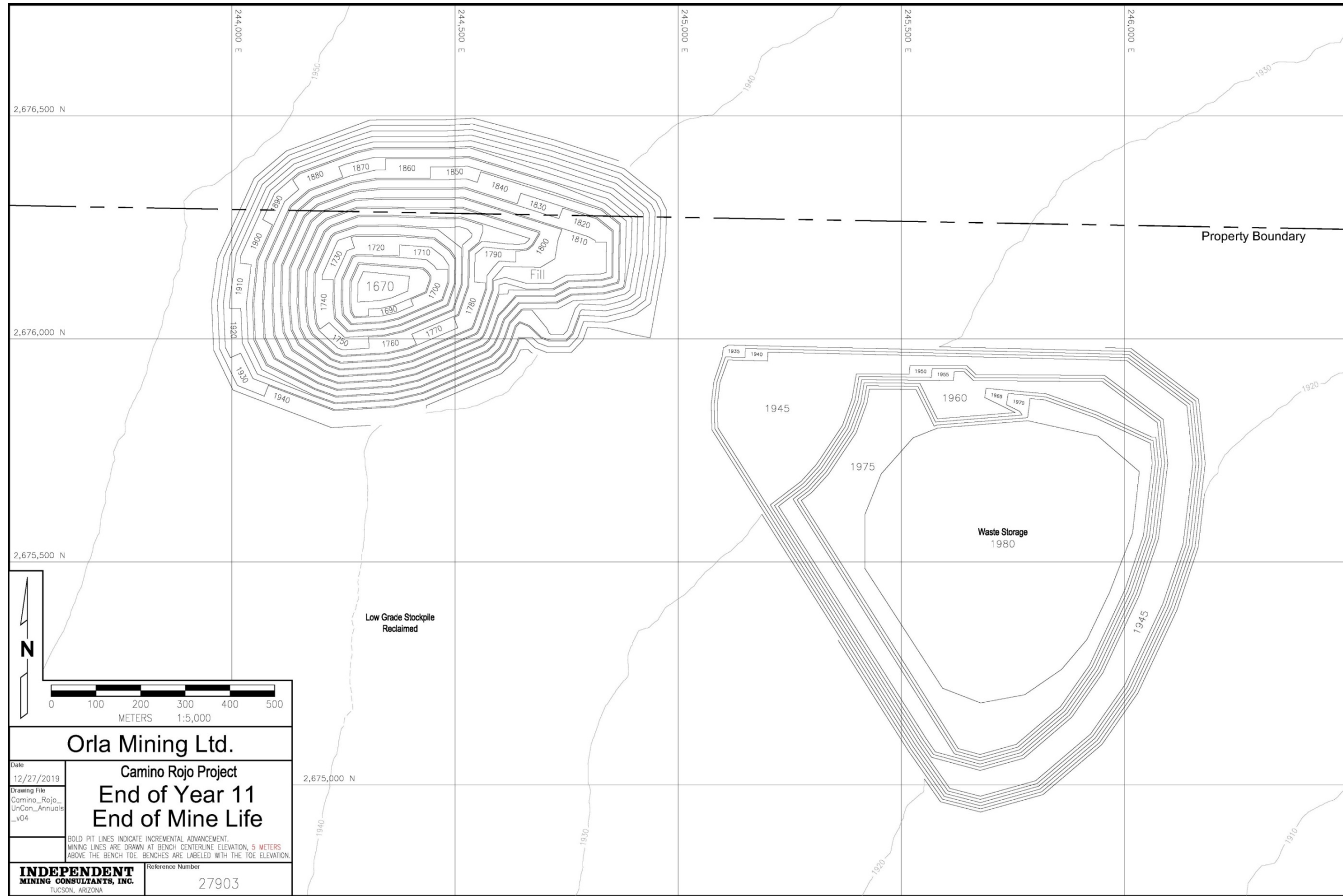

Figure 16.16 Year 11 – End of Low Grade Reclaim, IMC 2019

16.6 Mining Equipment

Mine major equipment requirements were sized and estimated on a first principles basis based on the mine production schedule, the mine work schedule, and estimated equipment productivity rates. The mine equipment estimate is based on contract-miner operation and assumes a well-managed mining operation with a well-trained labour pool.

Table 16-5 shows major equipment requirements for the initial and peak mining fleet. This table represents the equipment required to perform the following duties:

- Developing access roads from the mine to the crusher, waste storage area, and the low-grade stockpile,
- Mining and transporting resource to the crusher or low-grade stockpile,
- Mining and transporting waste to the waste storage facility,
- Maintaining the haul roads and waste storage areas.

Table 16-5
Mine Major Equipment Fleet Requirement

Equipment Type	Capacity/ Power	Initial Fleet	Peak Fleet
Atlas Copco (Epiroc) DM45 Blasthole Drill	(187 mm)	2	3
Sandvik DP1500 Blasthole Drill	(121 mm)	1	2
Komatsu PC1250 Hydraulic Excavator	(6.7 cu m)	1	2
Caterpillar 993K Wheel Loader	(14.5 cu m)	1	2
Caterpillar 777 Truck	(91 mt)	11	14
Caterpillar D8T Track Dozer	(231 kw)	2	3
Caterpillar 16M Motor Grader	(221 kw)	1	1
Water Truck	(50,000 l)	1	2
TOTAL		20	29

Note: Equipment in the table above was used for mine cost estimations. Actual equipment will vary by contractor.

17.0 RECOVERY METHODS

17.1 Process Design Basis

Test work results developed by KCA and others have indicated that the Camino Rojo Mineral Reserve is amenable to heap leaching for the recovery of gold and silver. Based on the Mineral Reserve of 67.4 million tonnes and established processing rate of 18,000 tpd of ore, the Project has an estimated mine life of approximately 10.4 years.

This Technical Report models a scenario where ore is mined by standard open pit mining methods. Ore will be crushed at a rate of 18,000 tonnes per day to 80% passing 28mm using a two-stage closed crushing circuit and conveyor stacked on the leach pad in 10-metre lifts. Lime will be added to the material for pH control before being stacked and leached with a dilute cyanide solution. Pregnant solution will flow by gravity to a pregnant solution pond before being pumped to a Merrill-Crowe plant for metal recovery. Gold and silver will be precipitated from the pregnant solution via zinc cementation. The precious metal precipitate will be dewatered using filters, dried in a mercury retort to remove mercury values, and smelted to produce the final doré product.

A summary of the processing design criteria is presented in Table 17-1. A detailed process design criteria document is referenced in Section 27 of this Technical Report.

**Table 17-1
Processing Design Criteria Summary**

ITEM	DESIGN CRITERIA
Annual Tonnage Processed	6,570,000 tonnes
Crushing Production Rate	18,000 tonnes/day average
Crushing Operation	12 hours/shift, 2 shifts/day, 7 days/week
Crusher Availability	75%
Crushing Product Size	80% -28mm
Conveyor Stacking System Availability	80%
Leaching Cycle, days (Total)	80
Average Sodium Cyanide Consumption, kg/t	0.35
Average Lime Consumption, kg/t	1.25
Average Oxide Gold Recovery, Kp	70%
Average Oxide Gold Recovery, Ki	56%
Average Transition-Hi Gold Recovery	60%
Average Transition-Lo Gold Recovery	40%
Overall Gold Recovery	62%
Average Oxide Silver Recovery, Kp	11%
Average Oxide Silver Recovery, Ki	15%
Average Transition-Hi Silver Recovery	27%
Average Transition-Lo Silver Recovery	34%
Overall Silver Recovery	20%

17.2 Process Summary

Ore will be mined using standard open pit mining methods and delivered to the crushing circuit using haul trucks which will direct-dump into a dump hopper; front-end loaders will feed material to the dump hopper as needed from a ROM stockpile located near the primary crusher. Ore will be crushed at a rate of 18,000 tonnes per day to a final product size of 80% passing 28mm (100% passing 38mm) using a two-stage closed crushing circuit. The crushing circuit will operate 7 days/week, 24 hours/day with an overall estimated availability of 75%.

The crushed product will be stockpiled using a fixed stacker, reclaimed by belt feeders to a reclaim conveyor, and conveyed to the heap stacking system by an overland conveyor system. Pebble lime will be added to the reclaim conveyor belt for pH control; agglomeration with cement is not needed.

Stacked ore will be leached using a drip irrigation system for solution application; sprinkler irrigation will be used beginning in Year 5 of operations to increase evaporation rates and reduce water treatment requirements from pit dewatering. After percolating through the ore, the gold and silver bearing pregnant leach solution drains by gravity to a pregnant solution vault tank where it will be collected and pumped to a Merrill-Crowe recovery plant. Pregnant solution will then be

pumped through clarification filter presses to remove any suspended solids before being deaerated in a vacuum tower to remove oxygen. Ultra-fine zinc will be added to the deaerated pregnant solution to precipitate gold and silver values, which will be collected by precipitate filter presses. Barren leach solution leaving the precipitate filter presses will flow to a barren solution tank and will then be pumped to the heap for further leaching. High strength cyanide solution will be injected into the barren solution to maintain the cyanide concentration in the leach solutions at the desired levels.

The precipitate from the Merrill-Crowe recovery plant will be processed in the refinery. Precipitate will be treated by an electric mercury retort with a fume collection system for drying and removal of mercury before being mixed with fluxes and smelted using an induction smelting furnace to produce the final doré product.

An event pond and pregnant solution pond are included to collect contact solution from storm or solution surge events. Solution collected will be returned to the process as soon as practical. Evaporators will be installed in the event pond by Year 5, as needed, to control excess solution generated by projected pit dewatering rates.

Figure 17.1 shows the overall process flowsheet and Figure 17.2 shows the general arrangement of the mine site.

All selected processes and equipment are established technologies used in gold and silver processing plants.

The overall plant site has been arranged to allow for possible future expansion.

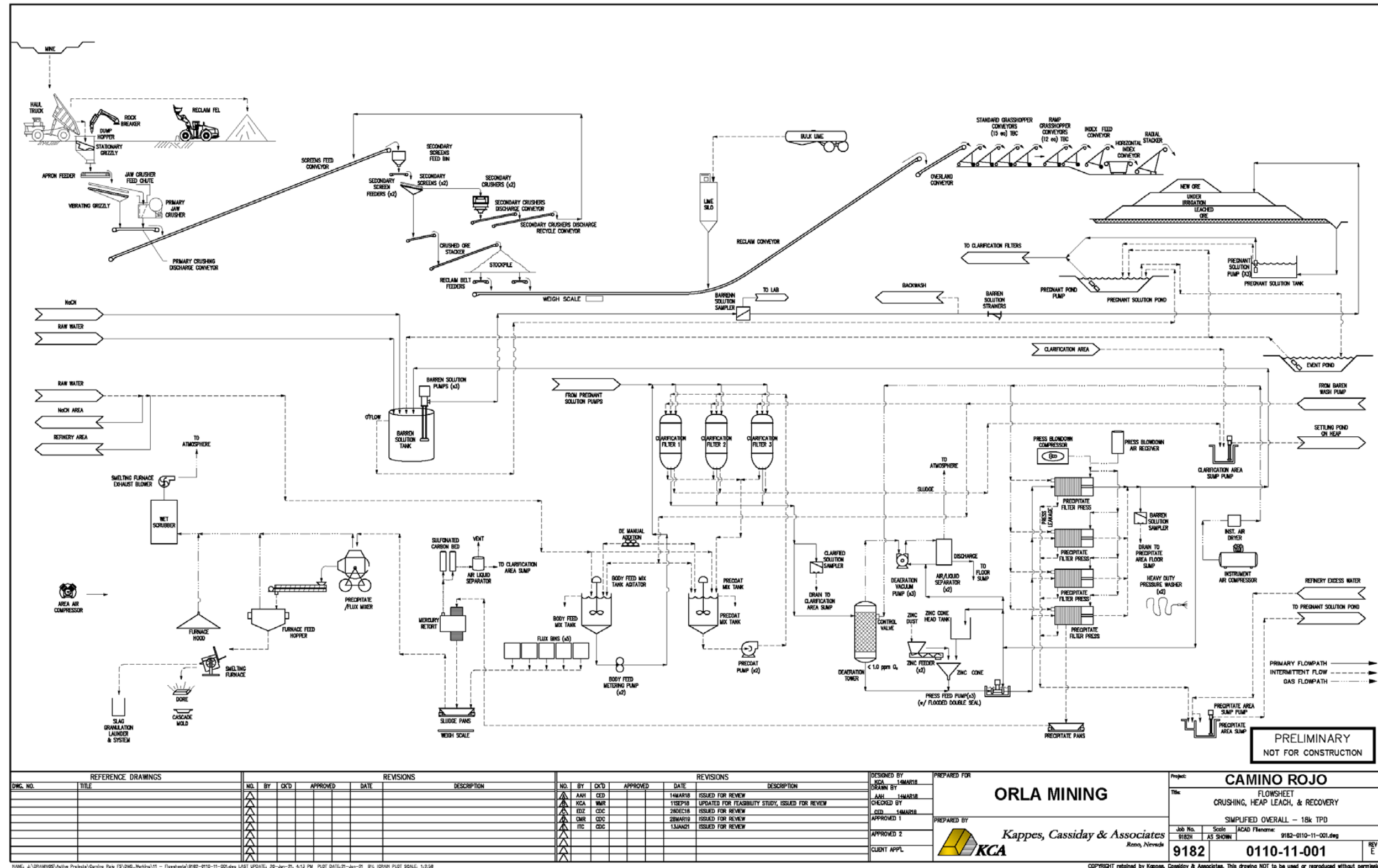

Figure 17.1 Process Overall Flowsheet

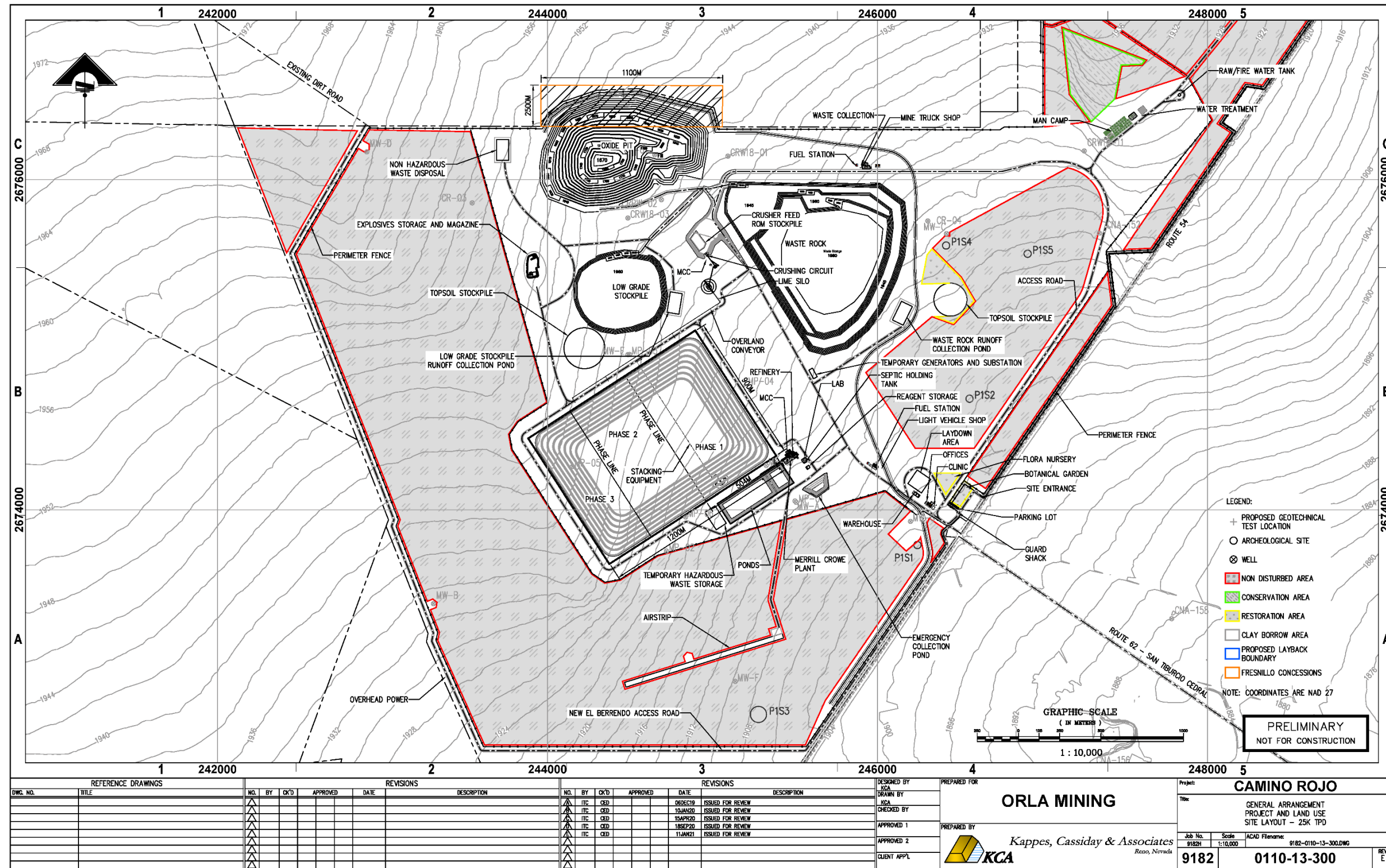

Figure 17.2 Project General Arrangement

17.3 Crushing

The following major components are included in the crushing facility:

- 200-tonne ROM Dump hopper with static grizzly;
- Hydraulic Rock breaker;
- 2,134mm x 7.32m Apron feeder;
- 1.52m x 3.05m Vibrating grizzly feeder;
- 1500mm x 2000mm Primary jaw crusher;
- 300-tonne surge bin;
- Two each 2.4m x 7.3m Double deck vibrating screens;
- Two each 500 HP Standard cone crushers; and
- Associated transfer conveyors, chutes and instruments.

ROM ore will be transported from the mine pit in 90-tonne surface haul trucks and will either be directly dumped into the crusher dump hopper or stockpiled in a ROM stockpile; approximately 9.2 million tonnes of low-grade material from the pit will be stockpiled in a low-grade stockpile and processed at the end of the mine life. Stockpiled ore from the ROM stockpile will be reclaimed by a front-end loader and fed to the dump hopper as needed. Oversized rocks or large lumps will be broken using a rock breaker. The crushing plant will process an average of 18,000 tonnes of ore per day.

Ore will be fed from the ROM dump hopper to a vibrating grizzly feeder via an apron feeder. The vibrating grizzly feeder will have parallel bars spaced 175mm apart with grizzly oversize being fed to the primary jaw crusher and the grizzly undersize being recombined with the jaw crusher product on the primary crusher discharge conveyor. The primary jaw crusher will operate with a 175mm discharge setting and has been oversized to allow for increased throughput for potential future expansion. The primary crusher discharge conveyor transfers primary crushed ore to the screen feed conveyor, which feeds the secondary screens. A tramp metal electromagnet and metal detector will be installed on the primary crusher discharge conveyor to protect the secondary crushers.

Primary crushed ore will be fed to a surge bin by the secondary screen feed conveyor which feeds the two secondary screens using belt feeders. The secondary screening circuit includes two double-deck vibrating screens with 100mm and 38mm top and bottom deck openings, respectively. Oversize material (+38mm) will be fed to the secondary cone crushers and undersize (-38mm) will be transferred to the crushed product stockpile stacker by the secondary screen undersize conveyor. Oversize material will be crushed by the secondary standard cone crushers which will operate with a 38mm closed side setting and will discharge onto the secondary crushers discharge conveyor. The secondary crushing circuit will be operated in closed circuit

with the secondary crusher discharge conveyor feeding a recycle conveyor which recycles the cone product to the secondary screen feed conveyor.

The secondary screen undersize (crushed product) will be 80% passing 28mm (100% passing 38mm). Crushed product will be transferred to the crushed product stockpile stacker by the screen undersize conveyor located beneath the secondary screens. The crushed product will be stockpiled in a conical stockpile which will be reclaimed using belt feeders and conveyed to the leach pad for stacking. The crushed product stockpile is approximately 60m in diameter and has an estimated live capacity of 6,000 tonnes, or about 8 hours of operation.

A modular motor control centre will be located in a container near the secondary crushing circuit. A PLC control unit will be located in a central control room which will control and monitor all crushing equipment, as well as monitor the conveyor stacking equipment. All of the conveyors will be interlocked so that if one conveyor trips out, all upstream conveyors and the vibrating grizzly feeder will also trip. This interlocking is designed to prevent large spills and equipment damage. Both of these features are considered necessary to meet the design utilization for the system.

Water sprays will be located at all material transfer points to reduce dust generation by the crushing circuit.

17.4 Reclamation and Conveyor Stacking

The following major components are included in the reclamation and conveyor stacking system:

- Two each 1524mm x 6m reclaim belt feeders
- 120-tonne lime silo with associated dust control and feeding equipment
- 1067mm x 348m overland conveyor
- Four each 1067mm x 35m standard grasshopper transfer conveyors
- Four each 1067mm x 205m overland transfer conveyor
- 12 each 1067mm x 35m grasshopper ramp conveyors
- 21 each standard grasshopper conveyors
- 1067mm x 18m index feed conveyor
- 1067mm x 35m horizontal index conveyor
- 1067mm x 41m radial stacker with 5m extendable stinger conveyor

The crushed product stockpile is sized to accommodate a total capacity of approximately 33,000 tonnes (live capacity of approximately 6,000 tonnes). Crushed ore will be reclaimed from the stockpile by two belt feeders to a reclaim conveyor in a tunnel below the stockpile. Pebble lime (CaO) for pH control will be added to the reclaim tunnel conveyor at an average rate of 1.25 kg

per tonne of ore from a 120-tonne silo equipped with a bin activator, variable speed rotary feeder, screw conveyor and dust collector. The reclaim conveyor discharges to an overland conveyor which transfers ore to the heap stacking circuit. The heap is divided into four primary stacking zones which are separated by grasshopper transfer conveyors and short overland conveyors. Transfer grasshoppers and connecting overland conveyors will be moved and operated as required based on the active heap stacking zone.

The heap will be constructed in 10-metre-high lifts, in cells 80 metres wide, using a mobile conveyor stacking system. The first lift will be stacked so that the toe of the heap is 10 metres from the inside toe of the perimeter berm. The effective overall slope of the heap will be approximately 2.5H:1V.

The heap stacking system consists of four each transfer overland conveyors (1067mm x 205m), four each grasshopper transfer conveyors (1067mm x 35m), 12 each ramp grasshopper conveyors (1067mm x 35m), 21 each standard grasshopper conveyors (1067mm x 35m), an index feed conveyor (1067mm x 18m), horizontal index conveyor (1067mm x 35m) and a radial stacker (1067mm x 41m). The transfer overland conveyors and transfer grasshoppers feed material to the grasshopper conveyors in the active stacking zone, which transfer the material to the conveyor stacking system. The conveyor stacking system includes the index feed conveyor, horizontal index, and radial stacker conveyors. The horizontal index and radial stacker are able to retreat and stack ore onto the heap. The number of grasshopper conveyors required varies depending on the area of the heap being stacked with a maximum of 33 grasshopper conveyors being required, not including the transfer grasshopper conveyors.

Once a lift of cells has finished leaching and is sufficiently drained, a new lift can be stacked over the top of the old lift. The old lift will be cross-ripped prior to stacking new material on top of any old heap area or access road/ramp to break up any compacted or cemented sections.

Stacked lifts will progress in a stair-step manner. The maximum planned heap height is 80m over the composite leach pad liner system. The planned leach pad will have a total of eight lifts.

17.5 Leach Pad Design

The final location for the leach pad and ponds was selected considering the available area within the Camino Rojo property, suitable pad foundation and the location of other project facilities. The leach pad location also allows for the development of future resources, without moving the pad. The leach pad will be a single-use, multi-lift type leach pad and has been designed with a lining system in accordance with International Cyanide Code requirements and meets or exceeds the North American standards and practices for lining systems, piping systems and process ponds to minimize the environmental risk of the facilities impacting local soils, surface water and ground water in and around the site.

The leach pad area will be constructed by clearing the pad area and stripping vegetation and growth medium. Only minor grading of the leach pad area will be required as the natural slopes are within the required range for solution drainage and stability.

The leach pad liner will be composed of the following lining system from top to bottom:

- Overliner consisting of 600mm of crushed and screened material (-19mm, + 0.43mm).
- 2mm smooth Linear Low Density Polyethylene (LLDPE) geomembrane.
- 300mm of compacted soil liner with a minimum permeability of 1×10^{-6} cm/sec or geosynthetic clay liner (GCL).
- Leak detection system under the primary solution collection pipes which route solution to a monitoring sump tank.
- Prepared subgrade

Clay borrow sources have been identified around the Project site for use as soil liner. These borrow sources will be amended with bentonite as needed to meet the 1×10^{-6} cm/sec permeability requirement. GCL will be used for portions of the heap if there are not sufficient quantities of clay borrow available or accessible at site.

The first phase of the heap leach pad will be constructed in Year -1 and includes 440,000 m² of lined area and will contain approximately two years' worth of ore production. Phase 2 of the leach pad will be constructed in Year 2 and includes 311,000 m² of lined area. Phase 3 of the leach pad will be constructed in Year 5 and has been sized to contain the ultimate cumulative ore capacity. A berm will be constructed during each phase, separating the consecutive phase areas from the previous. The phase separation berm includes temporary sections which will be removed to allow solution collection pipes for the following phase to connect with existing solution collection pipes from the previous phase.

Gravity solution collection pipes will be installed on top of the geomembrane liner and covered with overliner material. The pipes are sized to operate at 50% full to contain the design production flows from the upgradient tributary area, allowing additional capacity to accommodate excess solution from storm events.

The gravity solution collection pipes will consist of 100mm diameter perforated corrugated polyethylene (PCPE) tertiary pipes spaced on 8-metre centres flowing into larger double walled PCPE secondary pipes of 450mm in diameter. The secondary solution collection pipes will flow into primary solution collection pipes composed of double-walled 600mm PCPE pipe that will run along the toe of the southern and eastern heap perimeter berms. The primary solution collection pipes will exit the heap through a concrete weir to the solution collection channel. The pipes will

be solid walled as they enter the solution collection channel that flows into the pregnant solution vault.

Should solution flows exceed the capacity of the heap outlet pipes, solution head will build at the leach pad discharge area, causing excess solution to overflow the concrete weir into the solution collection channel.

The overliner material will act as a protective layer that resides above the LLDPE geomembrane. The main purpose of this material is to protect the composite liner system and solution collection piping from damage during material placement

The leak detection system will consist of 50mm perforated Polyvinyl Chloride (PVC) pipe which will be installed under the main solution collection pipes. The leak detection pipes will discharge to 200 L monitoring sump tanks outside of the heap perimeter berm. At the perimeter berm the perforated PVC pipe will transition to solid pipe and will pass through a 1000mm bentonite plug to ensure solutions are contained. The monitoring sumps will be checked daily to ensure no leaks are present. A single roll width of Geosynthetic Clay Liner (GCL) is installed over the leak detection trenches due to the increased solution flows at the primary solution collection piping.

**Table 17-2
Heap Leach Design Parameters**

ITEM	DESIGN CRITERIA
Ore Feed Rate, tpd	18,000
Total Capacity, t	
Planned Heap	67.4 Million
Design Provision	81.5 Million
Lift Height, m	10
Quantity of Lifts	8
Maximum stacking height, m	80
Stacked Ore Density, t/m ³	1.45
Front of Heap Slope, H:V	2.5
Side and Back Slopes of Heap, H:V	2.5
Setback Between Lifts, m	11.7
Angle of Repose, °	37
Leaching Cycle, d	80
Number of Leach Cycles	1
Leaching Schedule	
d/a	365
h/d	24
Tonnes Under Leach, t	1.4 Million
Active Leach Area, m ²	99,300
Solution Application Method	Buried Driplines or Wobbler Sprinklers
Solution Application Rate, Nominal, L/h/m ²	10
Heap Irrigation Rate, Nominal, m ³ /h	1000
Heap Leach Ore Moisture Retention, % of Total Ore Weight	7.8

17.6 Solution Application & Storage

The Camino Rojo Project will utilize a pregnant solution vault tank, pregnant solution pond, barren solution tank and event solution pond for solution management. An emergency pond will also be constructed down gradient from the Merrill-Crowe facility to catch any solutions resulting from a catastrophic containment failure, such as a burst pipe.

Solution management for the Camino Rojo Project is fairly simple. Pregnant solution from the heap will flow through the solution collection pipes to the pregnant solution vault where it is pumped to the Merrill-Crowe recovery plant. Overflow from the pregnant solution vault flows to the pregnant solution pond. The pregnant solution pond should be maintained in the mid-to lower range of its working capacity. The event pond should normally be maintained empty or at low levels whenever possible. It is important that the event pond be at minimum levels at the start of the wet season to ensure that it has the required capacity to contain both shorter and longer-term extreme precipitation events during the wet season. During Years 4 through the end of the Project life, water levels in the event pond should be maintained at the minimum allowable level for safe operation of the barge mounted evaporator units. Solution diverted to the pregnant or event ponds should be returned to the system as make-up water as soon as practical with every effort made to avoid storing excess solution over a long period of time.

Ore will be leached in a single stage using barren solution consisting of a dilute sodium cyanide solution. Additional residual leaching of ore will occur as leach solution from higher lifts percolates downward. Barren solution will be pumped from the barren solution tank to the active leach site using a dedicated set of vertical turbine pumps (two operating, one standby) and will be applied to the heap by a system of drip emitters. Drip emitters will be used as they generate less evaporation than sprinklers and will minimize the make-up water requirements. Wobbler Sprinklers will be used during Years 5 through the end of the Project life to help eliminate excess water from pit dewatering. Barren solution will be applied to the heap at an average rate of 10 L/h/m². Based on metallurgical test work results, a leach cycle of 80 days has been estimated. Concentrated cyanide will be added to the barren solution tank by metering pumps to maintain the cyanide in solution at 300-500 ppm NaCN. The barren solution tank is sized for 5 minutes of residence time at the Merrill-Crowe plant design flow rate of 1,200 m³/h. Antiscalant polymer will continuously be added to the leach solutions at an average rate of 10 ppm to reduce the potential for scaling problems within the irrigation system.

Pregnant solution containing gold and silver values from the heap drains by gravity to a pregnant solution vault from the heap. PCPE pipes will be placed on the geomembrane liner to facilitate the collection and transport of pregnant leach solution to the pregnant vault. During upset conditions, the pregnant solution vault will overflow to the pregnant solution pond. An emergency backup generator is included and has been sized to run the Merrill-Crowe and solution pumping

systems in the event of a power outage. The emergency generator is equipped with a day tank sized to supply fuel to the engine for 12 hours at full load.

The pregnant vault has a total volume of 56 m³ and has been sized based on the following criteria being contained within the pregnant pond:

- Working volume for 3 Minutes at 1200 m³/h of solution

The pregnant pond has a total volume of 94,000 m³ and has been sized based on the following criteria being contained within the pregnant pond:

- Working volume for 24 hours at 1379 m³/h of solution, based on potential for additional ore sources
- A 12-hour heap draindown volume of the leach solution (due to an event such as loss of power or pump) also at the solution application rate of 1379 m³/h
- Accumulation of solution resulting from a 24-hour precipitation event of 33mm over the entire lined area
- Dead storage volume assuming 1 metre of slimes at the bottom of the pond
- Freeboard of 1 metre below the top of the containment berm

The pregnant vault will be equipped with three vertical turbine pumps (two operating, one standby) which will pump pregnant solution to the Merrill-Crowe plant. The pregnant pond will be equipped with a submersible pump to return any accumulated solution back to the leach circuit. The submersible pump will be mounted on a pump slide on the pond side wall to facilitate the placement and extraction of the pump in the pond. An additional textured protective liner panel and conveyor belting will be installed on the pond sidewall in the area the pump slide is located to protect the pond liner.

Gold and silver will be precipitated from the pregnant solution by zinc cementation in the Merrill-Crowe facility and the resulting barren solution is returned to the barren solution tank. The pregnant solution pond will be constructed using the following composite liner system from top to bottom:

- 2mm smooth High Density Polyethylene (HDPE) primary liner
- geonet or double sided geocomposite
- 1.5mm smooth HDPE secondary liner
- geosynthetic clay liner (GCL)

Leak detection pipes will be provided beneath the primary pond liner to allow for monitoring and pumping of solutions from within the leak detection sumps.

An event pond is included with a total volume of 313,000 m³ and has been sized based on the following criteria being contained within the event pond:

- A 12-hour heap drain-down volume of leach solution at the design application rate of 1379 m³/h
- Accumulation of solution resulting from a 100-year, 24-h precipitation event of 130mm (113mm 100-year event plus 15%), less the 33mm of storm capacity accounted for in the pregnant pond
- Accumulation of solution resulting from wettest recorded monthly precipitation of 287mm
- Dead storage volume assuming 0.5m of slimes at the bottom of the pond
- Freeboard of 1m below the top of the containment berm

The event pond will be constructed using the following composite liner system from top to bottom:

- 2mm smooth HDPE primary liner
- geonet or double sided geocomposite
- 1.5mm smooth HDPE secondary liner
- geosynthetic clay liner (GCL)

Leak detection pipes will be provided beneath the primary pond liner to allow for monitoring and pumping of solutions from within the leak detection sumps.

The Event Pond will include a submersible pump mounted on a pump slide on the ponds side slope to return solution to the active leach circuit.

By incorporating normal working solution and drain down volumes in the Pregnant Solution Pond, it ensures that the Event Solution Pond will be used very infrequently, if at all during the first two years of operation. During typical operations, normal rainfall events can be accommodated in the Pregnant Pond as long as a significant heap drain down event does not occur at the same time. The solution storage system has been designed so that the barren solution tank overflows to the pregnant solution pond, and the pregnant solution pond overflows to the event pond in case of an emergency or significant storm event.

Expected in Year 5 of operation, barge mounted evaporators may be installed in the event pond, as needed, to facilitate removal of excess solution if pit dewatering requirements equal or exceed estimated projected rates (Ward, 2020). Up to 79 evaporator units may be installed.

Minimum pond storage requirements for Phases 1 through 3 are detailed Table 17-2, Table 17-3, and Table 17-5, respectively.

Table 17-3
Phase 1 Process Pond Storage Requirements

	Pregnant Pond (m ³)	Event Pond (m ³)	Total (m ³)
Dead Storage	8,748	16,331	25,079
Working Solution	23,834		23,834
Heap Draindown	11,917	11,917	23,834
Storm Precipitation	15,475	51,479	66,953
Wet Season Accum.		70,026	70,026
Total Work Vol. required	51,226	133,422	184,648
Total Vol. Incl. Dead	59,975	149,752	209,727

Pond sizing for phase 1 is based on a 900m x 504m lined heap area with the solution accumulations described above.

Table 17-4
Phase 2 Process Pond Storage Requirements

	Pregnant Pond (m ³)	Event Pond (m ³)	Total (m ³)
Dead Storage	8,748	16,331	25,079
Working Solution	23,834		23,834
Heap Draindown	11,917	11,917	23,834
Storm Precipitation	25,721	81,581	107,303
Wet Season Accum.		129,126	129,126
Total Work Vol. required	61,473	222,624	284,097
Total Vol. Incl. Dead	70,221	238,955	309,177

Pond sizing for phase 2 is based on a 900m x 849m lined heap area with the solution accumulations described above.

**Table 17-5
Phase 3 Process Pond Storage Requirements**

	Pregnant Pond (m ³)	Event Pond (m ³)	Total (m ³)
Dead Storage	8,748	16,331	25,079
Working Solution	23,834		23,834
Heap Draindown	11,917	11,917	23,834
Storm Precipitation	36,146	112,208	148,354
Wet Season Accum.		189,253	189,253
Total Work Vol. required	71,898	313,379	385,276
Total Vol. Incl. Dead	80,646	329,709	410,355

Pond sizing for phase 3 is based on a 900m x 1200m lined heap area with the solution accumulations described above. Ponds will be constructed for the phase 3 design requirements at the start of the Project.

17.7 Process Water Balance

17.7.1 Precipitation Data

The Camino Rojo Project area is in a relatively dry region which makes solution management fairly simple. Due to the very limited site rainfall, precipitation event control will be based upon the volume needed to store a sudden major storm event, using the pregnant and event ponds.

Precipitation data has been collected from several weather stations around the Project site. Average precipitation is based on the precipitation data from the San Tiburcio weather station which is approximately four kilometres from the Project. Average precipitation by month is presented in Table 17-6.

**Table 17-6
Average Monthly Precipitation – San Tiburcio Weather Station**

Month	Jan	Feb	Mar	Apr	May	Jun
Average Rainfall (mm)	13.3	10.4	6.4	17.4	37	32.9

Month	Jul	Aug	Sep	Oct	Nov	Dec	Annual
Average Rainfall (mm)	54.1	55	60	24.2	11.9	14	336.6

The 24-hr storm events based on different periods were estimated by NewFields and are presented in Table 17-7 and have been derived from the NewFields report titled “Diseño Conceptual de Manejo de Aguas Pluviales y Control de Sedimentacion, Proyecto Minero Camino Rojo, San Tiburcio, Zacatecas, Mexico” dated January, 2019 and referenced in Section 27 of this Technical Report.

Table 17-7
24-h Storm Event Estimations – NewFields

Period (Years)	Max 24 h (mm)
2	42.71
5	57.99
10	68.04
25	80.68
50	90.07
100	100.47
500	121.54
1000	131.41
5000	154.03
10000	164.89

Based on the NewFields report, the estimated 24-h storm event would be approximately 100.5mm. For the water balance analysis and pond sizing, a conservative 24-hr 100-year storm event of 113mm was used plus an additional 15% to account for climate change, making the design storm event of 130mm similar to the estimated 1000-year event.

Pan evaporation data for the water model are based on data from the Conception del Oro weather station and are summarized in Table 17-8. Pan evaporation was not monitored at the San Tiburcio weather station.

Table 17-8
Average Monthly Evaporation Data – Conception del Oro Weather Station

Month	Jan	Feb	Mar	Apr	May	Jun
Average Evap. (mm)	103.2	118.6	182.1	207.2	225.8	212.8

Month	Jul	Aug	Sep	Oct	Nov	Dec	Annual
Average Evap. (mm)	203.2	190.0	158.5	140.1	115.0	95.0	1928.7

17.7.2 Water Balance

Based on the preceding rainfall and pan evaporation data, active water balances were calculated based on the requirement for the full processing tonnage of 18,000 tpd. Water balance diagrams for an average year, wet year, and dry year and are presented in Figure 17.3, Figure 17.4 and Figure 17.5, respectively. For all scenarios, it was determined that the Camino Rojo Project will be in a water deficit and makeup water will be required. Makeup water requirements vary minimally between average, wet, and dry years due to the minimal overall precipitation at the Project site. Average Make-up water requirements in cubic metres per hour are summarized in Table 17-9. Pit dewatering influences on the water balance are not included.

**Table 17-9
Average Make-up Water Requirements**

Description	Value	Comments
Crusher Dust Control	11.3	From Water Balance Diagram
Heap Leach Usage	52.3	From Water Balance "Dry Year Diagram"
Road Dust Control	15.0	Allowance
Truck Shop Wash Down	1.0	2.3 m ³ /h for 45 minutes, 7 times a day = ~0.4 m ³ /h. Assume 1 m ³ /h (6400 gal/day) allowance.
Camp Usage	2.6	0.25 m ³ /day per person, assume 250 permanent design population
Buildings		
- Admin	0.5	allowance for bathroom / potable water
- Plant Shop & Warehouse	0.5	allowance for misc. usage / spillage / clean-up
- Mine Shop & Warehouse	1.0	allowance for misc. usage / spillage / clean-up
- Laboratory	1.0	allowance for misc. usage / clean-up
- Merrill-Crowe	5.0	allowance for misc. usage / spillage / clean-up
- Refinery	0.5	allowance for misc. usage / spillage / clean-up
TOTAL Water Required	90.6	m³/h
or	25	L/s

Camino Rojo - Heap Leach Project
AVERAGE YEAR PROCESS WATER BALANCE

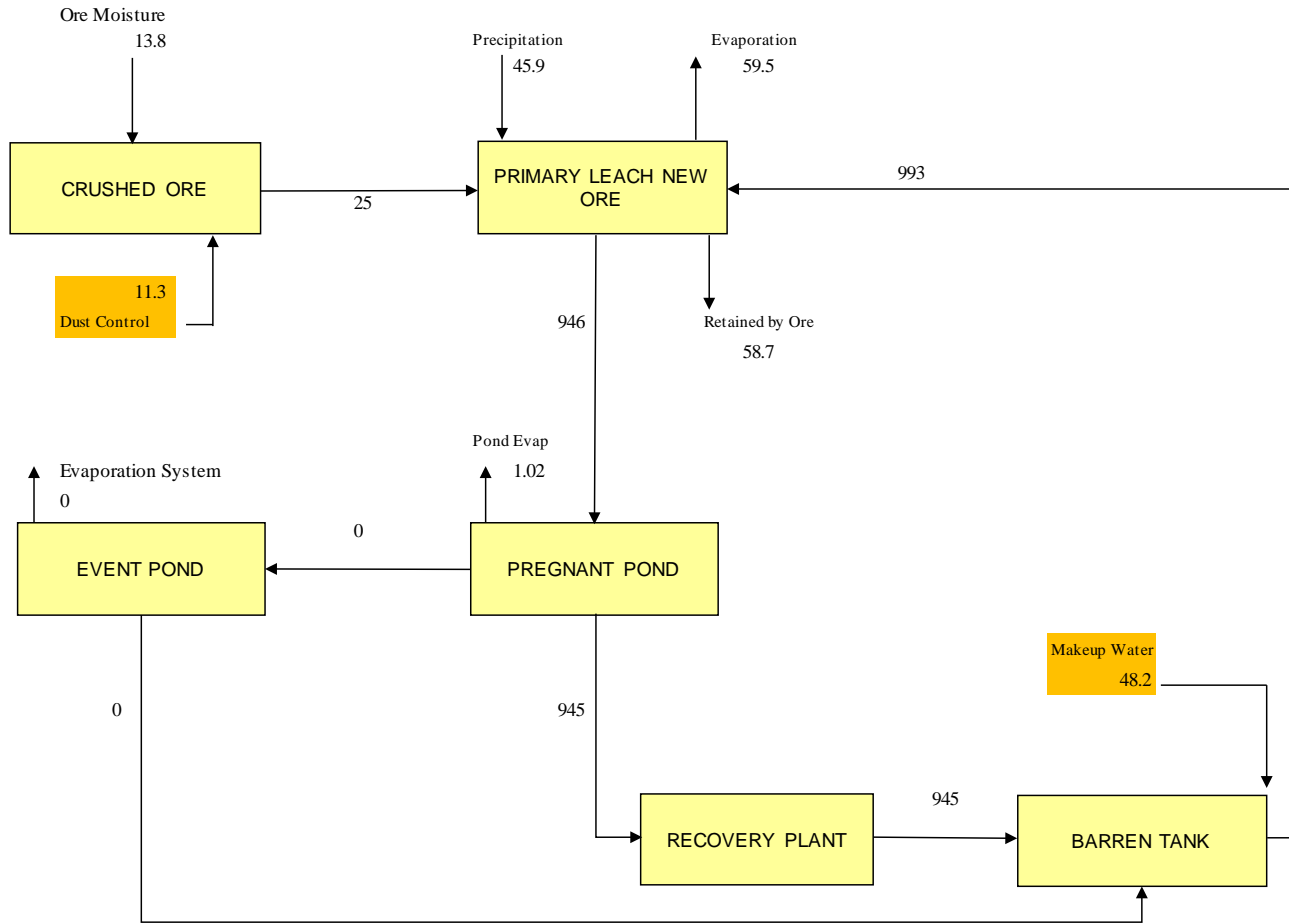

All values are solution m³/hr.
 Due to extreme low annual precip & high evap, it is assumed that rain falling on idle heap areas is absorbed & does not report to off-flow.
 It is assumed the water added for crusher area dust control reports to the heap.

Figure 17.3 Average Year Water Balance Diagram

Camino Rojo - Heap Leach Project
WET YEAR PROCESS WATER BALANCE

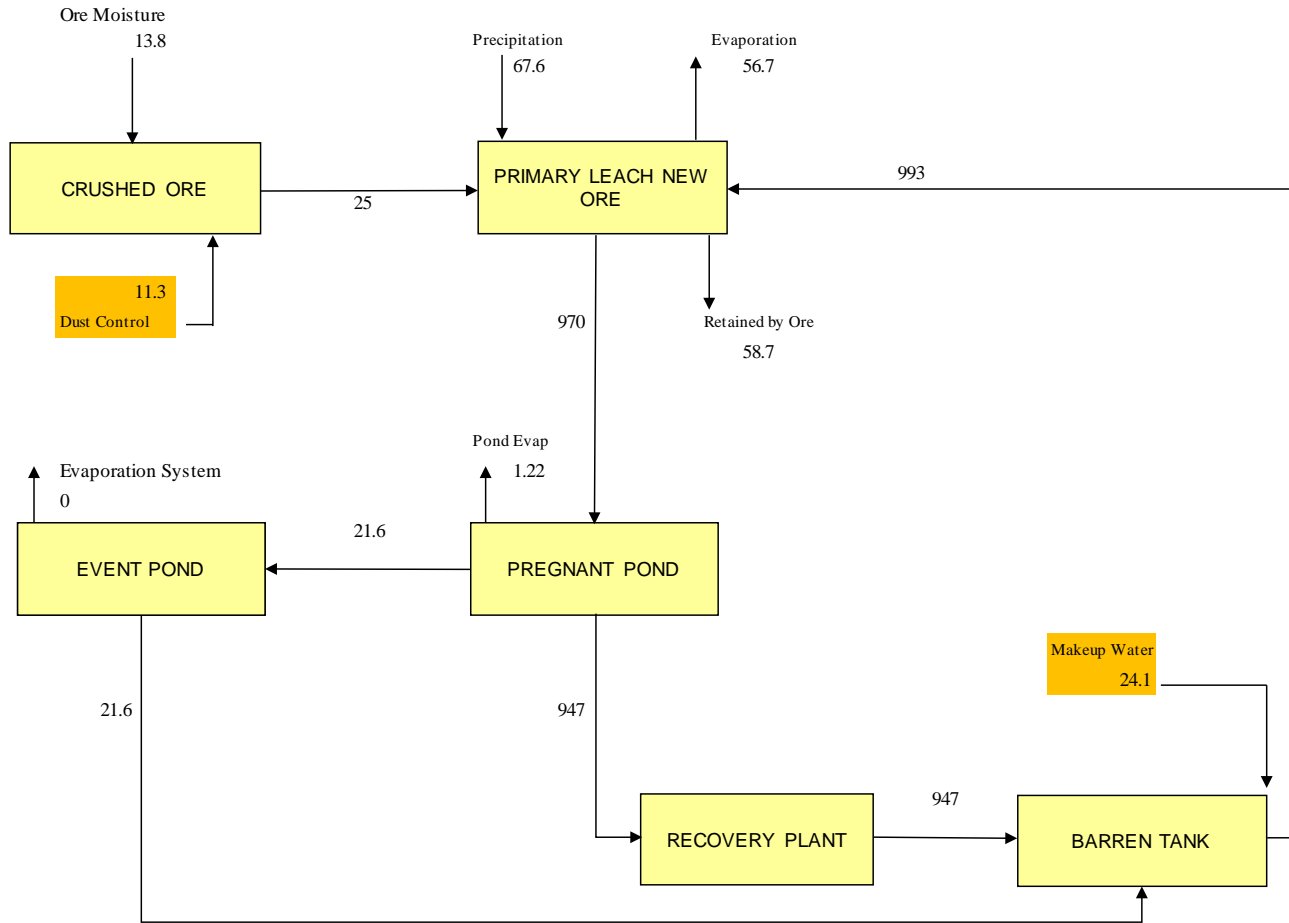

All values are solution m³/hr.
 Due to extreme low annual precip & high evap, it is assumed that rain falling on idle heap areas is absorbed & does not report to off-flow.
 It is assumed the water added for crusher area dust control reports to the heap.

Figure 17.4 Wet Year Water Balance Diagram

Camino Rojo - Heap Leach Project
DRY YEAR PROCESS WATER BALANCE

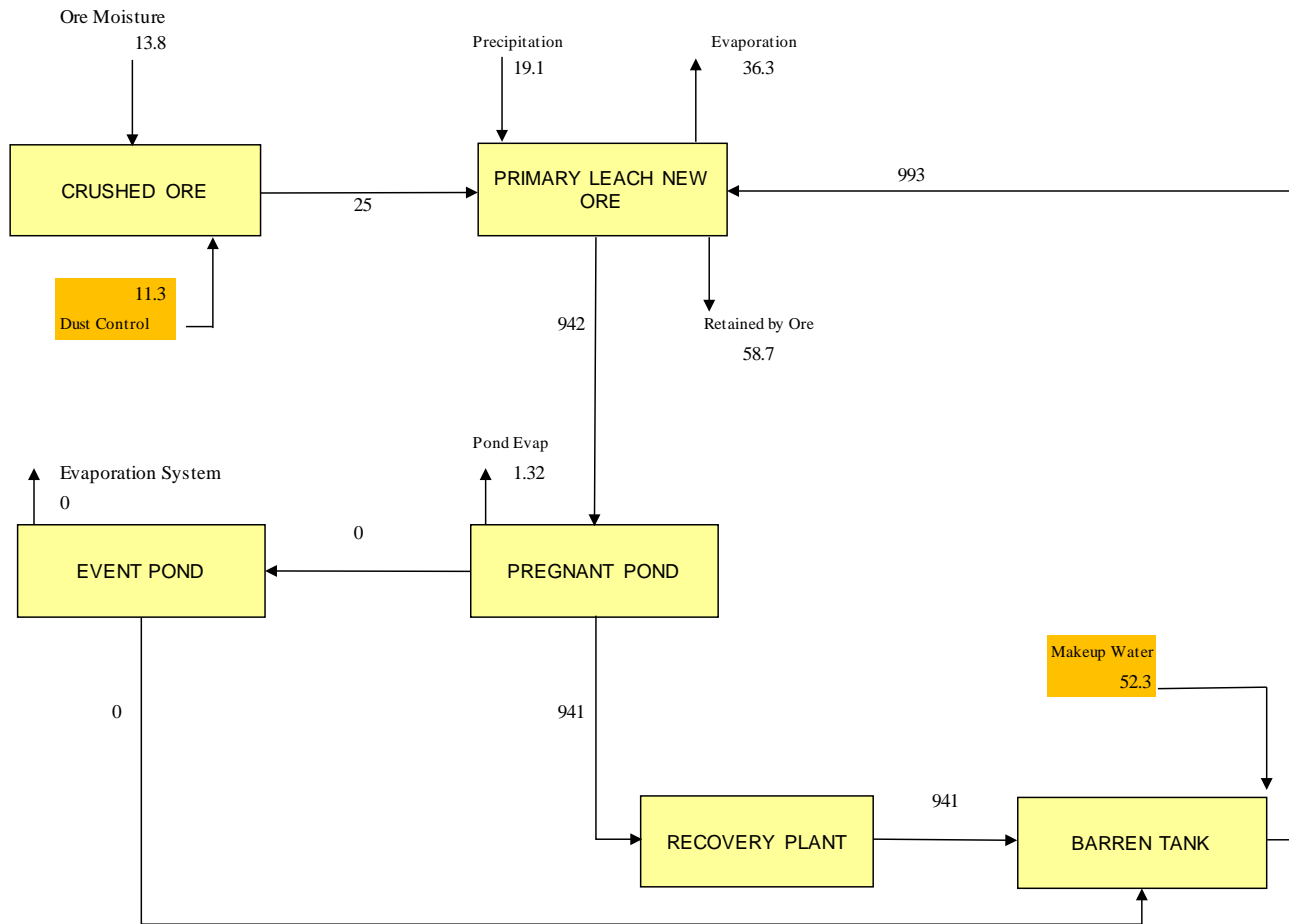

All values are solution m³/hr.
 Due to extreme low annual precip & high evap, it is assumed that rain falling on idle heap areas is absorbed & does not report to off-flow.
 It is assumed the water added for crusher area dust control reports to the heap.

Figure 17.5 Dry Year Water Balance Diagram

17.8 Merrill-Crowe Recovery Plant

A Merrill-Crowe recovery plant is designed to recover gold and silver values from pregnant solution by zinc precipitation. The recovery plant will be constructed on a concrete containment slab located outdoors. The zinc addition and filter pre-coat circuits will be fully enclosed inside a steel building. Precipitation filtration and smelting operations will be located in a separate enclosed, secure building. The motor control centre will be housed in a separate room proximal to the recovery plant area.

The Merrill-Crowe recovery plant and refinery layouts are presented in Figure 17.6.

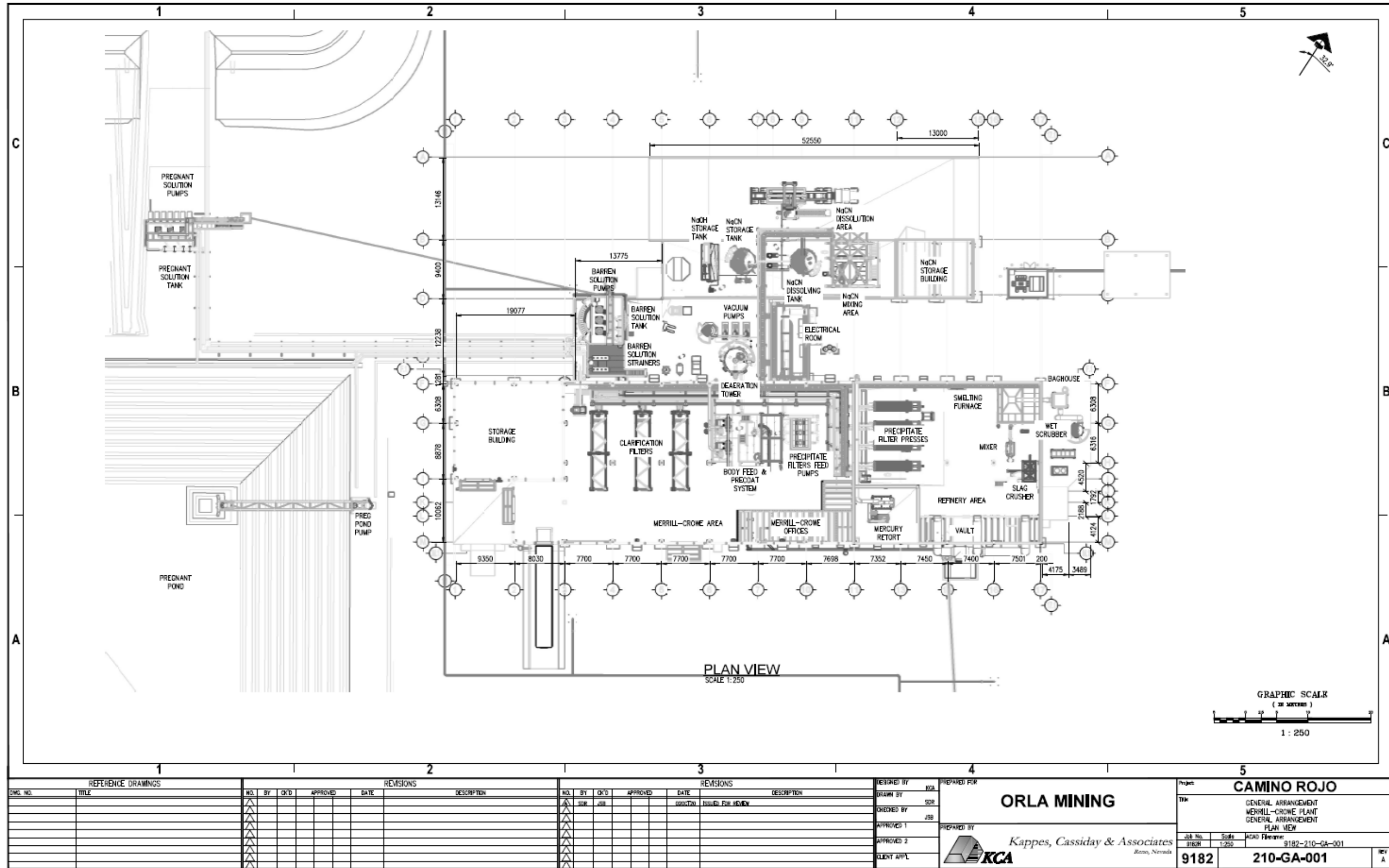

Figure 17.6 Merrill-Crowe Recovery Plant & Refinery Layout

REFERENCE DRAWINGS				REVISIONS				REVISIONS				DESIGNED BY		PREPARED FOR		Project		
DWG. NO.	TITLE	NO.	BY	OK'D	APPROVED	DATE	DESCRIPTION	NO.	BY	OK'D	APPROVED	DATE	DESCRIPTION	DESIGNED BY	PREPARED BY	Job No.	Scale	ACAD File Name
																9182	1:250	9182-210-GA-001
																210-GA-001		

ORLA MINING

Kappes, Cassiday & Associates
Reno, Nevada

KCA

Job No. 9182
Scale 1:250
ACAD File Name 9182-210-GA-001

Project **CAMINO ROJO**
Title GENERAL ARRANGEMENT
MERRILL-CROWE PLANT
GENERAL ARRANGEMENT
PLAN VIEW
Job No. 9182
Scale 1:250
ACAD File Name 9182-210-GA-001
REV A

The following major plant components are included in the Merrill-Crowe facility:

- Three each 280 m² parallel pressure leaf clarification filters, (2 operating);
- Diatomaceous earth filter pre-coat and body feed systems;
- 3.9m diameter. x 13m tall Deaeration tower;
- Zinc addition circuit;
- Four each 231 m² plate and frame precipitate filter presses (3 operating, 1 standby); and
- Miscellaneous pumps.

The Merrill-Crowe plant will be mostly automatic with local Human Machine Interface (HMI) panels displaying unit functions and controlling primary flow streams. Non-primary or batch flow streams, such as smelting, retorting precipitate press cleaning, etc. will be controlled manually. All local sensors will provide a signal for monitoring from the master PLC which will control the Merrill-Crowe circuit based on level or solution flow set point for the pregnant solution pumps by controlling pump VFDs.

Pregnant solution at the nominal rate of 1,000 m³/h (1,200 m³/h design) will be pumped to two of the three pressure leaf type clarification filters (two operating, one on backwash/clean/precoat cycle) with a design input pressure of 517 kPag (75 psig). The clarification filters are designed to remove suspended solids down to levels of less than 1 mg/L before removal of oxygen in the deaeration tower. Diatomaceous Earth (DE) for the clarification filters will be prepared in a body feed mix tank and transferred to a pre-coat mix tank. DE from the pre-coat mix tank will be used to precoat the clarification filters. A portion of body feed solution will be metered into the pregnant feed solution to the clarification filters during operation. It is assumed that the clarification filters will require pre-coating once each day.

The clear pregnant solution from the clarification circuit will be sent to the deaeration tower for removal of oxygen. Clear pregnant solution then flows into the deaeration tower and passes through a bed of high surface area packing material. Liquid seal ring vacuum pumps (two operating, one standby) with a design flow of 1400 m³/h each at 24 kPa absolute provide sufficient degassing capacity to maintain oxygen levels in solution of less than 1 ppm.

Deaerated clarified pregnant solution then discharges from the tower and is pumped to three of four precipitate filter presses. Ultra-fine zinc will be added at the press feed pump suction to precipitate gold and silver from the deaerated pregnant solution. Lead Nitrate (PbNO₃) may be mixed and metered into the zinc cone as needed to improve Merrill-Crowe efficiencies by forming cathodically charged areas of lead with negatively charged gold cyanide ions being reduced preferentially at these polarized regions. Zinc precipitation is performed at ambient temperatures. Precipitated gold and silver from the ultra-fine zinc will be collected in the precipitate filter presses which have a design operating pressure of 689 kPag (100 psig). A release coat of DE is added

to the precipitate filter presses before each filter is brought online for collecting precipitated metals from solution. A portion of body feed solution will be metered into the deaerated pregnant feed solution to the precipitate filters during operation.

Solution discharging from the filter presses will be stripped of gold and silver and is termed barren solution. The barren solution will be returned to the barren solution tank, which acts as a surge tank and a head tank for miscellaneous uses of barren solution within the facility (gland water, wash down, fresh cyanide solution make-up, etc.) as well as irrigation solution for the heap.

17.8.1 Refinery

Precipitate from the Merrill-Crowe circuit will be processed in the refinery to produce a doré bar. The refinery circuit includes the following major components:

- A 0.84 m³ electric mercury retort;
- A 113 L Induction smelting furnace;
- A smelting furnace hood and off-gas extraction blower;
- A smelting furnace off-gas scrubber system; and
- A slag handling circuit

Periodically, one of the precipitate presses will be taken off-line and the empty pre-coated press will be put on line. The press taken off-line will then be put on a compressed air blow cycle to dry the filtered precipitate. After a four-hour blow dry, the press will be opened and the precipitate, with a moisture content ranging from 15 to 20 percent, drops into pans below the press. The pans will be loaded into an electric mercury retort with a fume collection system for drying and removal of mercury before being mixed with fluxes in preparation for smelting. The mercury retort will operate at temperatures up to 650 °C under vacuum. Condensers cool the retort gas stream, condensing most of the mercury which has been vaporised, which is collected while the final gas stream is further cooled by aftercoolers and then passes through sulphonated carbon columns before being discharged to ensure there is no remaining mercury in the emissions stream. Recovered mercury is considered as a hazardous waste and will be transported off site for disposal.

The mixed precipitate and fluxes will be fed to the tilting induction furnace by a screw conveyor. The induction furnace is designed to operate at temperatures up to 1260 °C to melt the metal values present. After melting, slag will be poured off into cascading cast iron moulds until the remaining molten furnace charge is mostly molten metal (doré). Doré will be poured off into 40 kg bar moulds, cooled, cleaned, and stored in a vault pending shipment to a third-party refiner. The doré poured from the furnace will represent the final product of the processing circuit.

Slag will be reprocessed using a fine jaw combo crusher and re-smelted to recover any remaining metal values.

A hood will collect the furnace fumes which will pass through a series of scrubbers including a multi-cone baghouse to remove zinc oxide particles, a wet scrubbing system to remove particulates and a sulphonated carbon scrubber to remove any remaining mercury vapour. The system will be designed to remove over 98% of the particulates present in the exhaust fumes.

The refinery will require detailed inspections of all persons entering and leaving through the guard shack, including management personnel. Doré will be poured and loaded in an area under constant video surveillance. For added security, the security contractor will be present starting from the point where the doré is removed from the storage facility and thereafter accompany the vehicle to the airstrip or the armored truck to the main gate.

17.8.2 Process Reagents and Consumables

The reagent handling systems includes all equipment required to mix and or store reagents required for the Camino Rojo Project.

Average estimated annual reagent and consumable consumption quantities for the process area are shown in Table 17-10.

**Table 17-10
Projected Annual Reagents and Consumables**

Item	Form	Storage Capacity	Average Annual Consumption
Sodium Cyanide	SLS Cyanide mix system, ~20 tonne shipments, briquettes in 1000 kg super sacks for emergency use	10 days	2,300 tonnes
Lime (CaO)	Bulk Delivery (20 tonne)	5.3 days	8,200 tonnes
Antiscalant	Liquid Tote 1 m ³ Bins	1 Month	175 m ³
Zinc	Dry Powder, 50 kg canisters	1 Month	50.5 tonnes
Lead Nitrate	Dry Powder, 25 kg bags	1 Month	5.1 tonnes
Diatomaceous Earth	Dry Powder, 454 kg supersacks	1 Month	530 tonnes
Silica	Dry Solid Sacks	1 Month	2.1 tonnes
Borax	Dry Solid Sacks	1 Month	11.7 tonnes
Niter	Dry Solid Sacks	1 Month	4.4 tonnes
Soda Ash	Dry Solid Sacks	1 Month	8.2 tonnes

17.8.2.1 Lime

Pebble lime (CaO) will be delivered in 20-tonne pneumatic trucks. Storage will be provided in one 120-tonne silo and the estimated consumption is 1.25 kg/tonne material which will be metered onto the crushed product reclaim conveyor using a rotary feeder and screw conveyor.

17.8.2.2 Sodium Cyanide

Cyanide used for leaching and other process applications will be mixed in 18 to 20-tonne batches onsite using an SLS (Solid to Liquid) Cyanide mix system. Cyanide will be delivered in certified iso-containers in solid form. At site, process solution will be added to a 95 m³ NaCN dissolution tank and circulated through the delivery container back to the dissolution at ambient temperatures and a design pressure of 147 kPa (15m TDH). Once the cyanide is completely dissolved, the connecting hoses and pipes are cleared pneumatically to ensure there is no remaining cyanide solution in the delivery container or piping. The concentrated cyanide solution (25% NaCN by weight) is then transferred to a 95 m³ Cyanide storage tank for delivery to the process by metering pumps.

An extra SLS cyanide container is planned to be stored on site in the event of a delay in delivery. In the event of a significant delay in delivery, an emergency cyanide mix system will be available to mix briquettes delivered in 1,000 kg bulk bags. Emergency cyanide in bulk bags will be stored on a concrete slab with drainage controls in a secure, fenced, and completely enclosed area.

The Cyanide dissolution tank, cyanide storage tank, and emergency cyanide mix tank are all in concrete containment sized to hold 110% of the largest tank volume. The concrete containment will have appropriate water stops to ensure containment of solutions.

Cyanide consumption for the process is approximately 0.35 kg/tonne of ore processed.

17.8.2.3 *Caustic*

Caustic solution at 50% concentration by weight will be used as a pH buffer for cyanide mixing. Caustic solution will be stored in a 55 m³ horizontal steel tank adjacent to the cyanide mix system.

17.8.2.4 *Zinc*

Ultra-fine zinc will be added to the zinc cone every shift and consumption will be approximately 150 kg/day at an assumed rate of three times the metal precipitated. An inventory of 90 canisters of 50 kg each will be stored onsite (approximately a 30-day supply).

17.8.2.5 *Lead Nitrate*

Lead Nitrate will be delivered in 25 kg sacks, mixed at site and metered to the zinc cone at a rate of 10% of the zinc addition rate if needed. Lead nitrate is consumed at an average rate of 15 kg/day. A 30-day supply will be stored at the Merrill-Crowe plant.

17.8.2.6 *Diatomaceous Earth*

Diatomaceous earth will be consumed at an average rate of 1.4 tonnes per day for pre-coating the filters in the Merrill Crowe plant. A one-month reserve supply will be kept onsite in case of supply interruptions and will be stored in an enclosed reagent storage building.

17.8.2.7 *Antiscalant*

Antiscalant agents will be used to prevent the build-up of scale in the process solution and heap irrigation lines. Antiscalant agent will normally be added to the process pump intakes, or directly into pipelines. Consumption varies depending on the concentration of scale-forming species in the process stream. Delivery will be in liquid form in 1 m³ (1-tonne) bulk containers.

Antiscalant will be added directly from the supplier bulk containers into the pregnant and barren pumping systems using variable speed, chemical-metering pumps. On average, antiscalant consumption is expected to be about 10 kilograms per 1,000 m³ (10 ppm) of process solution to be treated (pregnant and barren), or approximately 500 Litres per day.

17.8.2.8 Fluxes

Various fluxes will be used in the smelting process to remove impurities from the bullion in the form of a glass slag. The normal flux components will be a mix of silica sand, niter, borax, and sodium carbonate (soda ash). The flux mix composition is variable and will be adjusted to meet individual project smelting needs. Dry fluxes will be delivered in 25-kg or 50-kg bags. Average consumption of fluxes has been estimated at 1.75 kilograms per kg of gold and silver produced.

18.0 PROJECT INFRASTRUCTURE

18.1 Infrastructure

18.1.1 Existing Installations

Existing infrastructure at the Camino Rojo Project includes an exploration camp in the town of San Tiburcio capable of housing approximately 40 people and dirt and gravel roads throughout the property. Internet and limited cellular communications are currently available, though these systems will need to be expanded for operations.

18.1.2 Site Roads

Access to the Project site is by the paved four lane Mexican Highway 54 and Route 62, a secondary paved highway that passes through San Tiburcio. The Project is approximately 260 km southwest of Monterrey and 190 km northeast of Zacatecas. A private road will enter into the mine property approximately 250 metres northeast of the intersection of Highway 54 and Route 62. This road will provide access to the camps, offices, mine, process plant and other Project facilities. The entrance to the property will be located at NAD27 246493E, 2673864N, Zone 14. Site access roads will be constructed during pre-production and will include approximately 24 km of dirt and gravel roads.

At the existing intersection, an unpaved road and accompanying powerline continue to the town of El Berrendo, approximately 6.5 km northwest of the Project. Both the road and powerline will intersect critical mining facilities, therefore rerouting them will be necessary. The intersection will remain intact, but the road and powerline to El Berrendo will be diverted along the western boundary of the Camino Rojo property until they intersect the existing road and powerline on the north end of the property. This 7.8 km access road will be paved with asphalt and constructed within the Camino Rojo property boundary. Both the existing intersection and the mine entrance will have acceleration and deceleration lanes on both northbound and southbound directions.

18.1.3 Mine Haulage Road

The main production haul road will be finished during the construction phase to support pre-stripping and pre-production activities. There will be multiple branches off the main haul road from the pit, including access to the mine truck shop, waste rock dump and low-grade stockpile. Approximately 2.6 km of haul roads will be constructed from the top of the pit ramp to all associated haul truck destinations.

18.1.4 Project Buildings

Site buildings for the Camino Rojo Project will primarily be prefabricated steel buildings or concrete masonry unit buildings. Site buildings include:

- Administration Building;
- Mine Camp Facilities;
- Merrill-Crowe Process Facility;
- Refinery;
- Laboratory;
- Process Maintenance Workshop;
- Reagent Storage Building;
- Mine Truck Shop;
- Contractor Mine Office Building;
- Light Duty Truck Shop;
- Fuel Stations;
- Warehouse;
- Explosives Magazine;
- Guard House; and
- Medical Clinic

18.1.5 Administrative Offices

A 600 m² administration building will be constructed with Concrete Masonry Units (CMU) brick with stucco finish and will include permanent office space for approximately 30 employees and additional offices for temporary use. Two entrances, two emergency exits, men and women's washrooms, a coffee area, a server room and a meeting room will also be included. This facility will include potable and fire water supply along with septic holding tanks sized for service on a weekly basis. The administration building will also include a 75 m² room designated for training of personnel.

18.1.6 Mine Camp Facilities

The Project has an existing camp in San Tiburcio with single and multi-room layouts that can house approximately 40 people. The existing camp will be expanded by adding four room, private bathroom modular units at the beginning of construction and will house the Minera Camino Rojo and EPCM personnel. Housing and accommodations for construction contractors and their employees will be the responsibility of the individual contractors.

Construction of an operations camp will begin early during the construction phase and will be fast tracked so that at least some of the units are available during the commissioning phase to allow for additional space for consultants and vendor reps. The operations camp will include two different types of modules: “A” camp and “B” camp units. The “A” camp units consist of 8 double rooms with accommodation for 2 single beds or double bunkers and shared bathroom facilities consisting of four each toilets, showers and wash basins. The “B” camp units consist of 8 double rooms with accommodations for 2 single beds or double bunkers and a private bathroom in each room. The camp will include 8 each “A” type and 6 each “B” type camp units with a total of 112 planned rooms. The total Camp Capacity is presented in Table 18-1.

**Table 18-1
Camp Capacity**

Description	Unit Qty	Normal Occupancy per Unit	Maximum Occupancy per Unit
Type A Dorm	8	16	32
Type B Dorm	6	16	32
Total Camp		224	448

Other facilities included as part of the operations camp include a laundry facility, kitchen and dining facility, and a recreation building. The laundry building will be a modular type facility and will contain washer and dryer units for cleaning clothes and linens for the camp operations as well as a bathroom.

The cooking and dining facilities will be a pre-engineered steel building and will be constructed near the camp to cater for approximately 460 workers. This insulated, steel walled building will include all storage areas for dry and refrigerated food, cooking equipment and serving stations for catering as well as seating and tables for personnel.

The recreation building will be a pre-engineered steel building and includes areas for a full gym, multiple TV viewing areas, men’s and women’s wash room and areas for game tables.

18.1.7 Merrill-Crowe Process Facility

Pregnant solution from the heap leach will be processed in a Merrill-Crowe recovery plant where gold and silver will be precipitated from deaerated pregnant solution with ultra-fine zinc. A 1,600 m² uninsulated steel walled building with an eave height of 10 metres will contain the clarification filters, pre-coat systems zinc feed systems and storage for the Merrill-Crowe process facility. This building will have three rollup doors, two man-doors, washroom, offices, an atomic adsorption room for solution analysis and all other associated equipment for the Merrill-Crowe process.

Liquid samples such as PLS, barren solution and other solutions from the process will be assayed using the atomic adsorption unit in the Merrill-Crowe building for gold and silver. The facility will include all necessary eyewash/safety shower water and firewater provisions.

18.1.8 Refinery

Precipitate from the Merrill-Crowe circuit will be processed in the refinery to produce doré bars. A secure, barbwire fenced, 8-metre tall CMU brick building adjacent to the Merrill-Crowe facility will house the refinery and have secure access for personnel and armored trucks. This building will house the precipitate filter presses, flux mixing system, mercury retort and smelting furnace and will include secured entry room, washroom, laundry room, mercury retort room, security office and vault. This will be a CMU brick building of approximately 790 m². Adjacent to the refinery will be a sulphonated carbon column and wet scrubber for Merrill-Crowe and refinery exhausts.

18.1.9 Laboratory

A laboratory facility will be constructed near the Merrill-Crowe plant and will process samples from the mine and process. Chemical and fire assays for full support to the operation will be provided and operated by the owner. This insulated, steel walled facility will include a wet lab, atomic adsorption and fire assay capabilities to have the capacity for 150 assays per day. Doré samples will be assayed at the onsite lab and then later by a third party at an external lab. The laboratory will include all necessary eyewash/safety shower water and firewater distribution.

18.1.10 Process Maintenance Workshop

Process equipment will be repaired and maintained in a process maintenance workshop. A three-sided, steel walled, uninsulated 330 m² facility will be located near the Merrill-Crowe building. This will include an open shop area, men and women's washrooms, a break room and two offices. The work shop will be equipped with air supply and distribution, welding plug sockets, wash water and firewater supply and distribution.

18.1.11 Reagent Storage

A steel walled reagent storage building will be adjacent to the Merrill-Crowe process facility and will be approximately 100 m². This will include room for 10 pallets of diatomaceous earth, 10 super sacks of NaCN and 5 bins of antiscalant. Concrete containment will have the capacity for 110% of the largest container within the reagent storage building and includes appropriate water stops to meet the international cyanide code.

18.1.12 Mine Truck Shop

The major mining equipment fleet is summarized in Section 16.6. The truck shop is designed with a semi-open arrangement to include repair bays for trucks, ancillary equipment, light vehicles, wash and welding areas.

An uninsulated steel-sided 600 m² mine truck shop with three bays will be utilized for fleet maintenance. An office, lunch room, men and women's washrooms, a storage area and firewater supply and distribution will also be included. The height of the mine truck shop will be approximately 16 metres. An attached 200 m² wash bay will be used for washing mine equipment. Adjacent to the wash bay will be an oil skimmer to collect the oil in the wash water from the wash bay.

Crane work will be conducted within the mine truck shop with a 10-tonne overhead crane. Maintenance fluids will be distributed to each bay by the means of lubrication stations, each with a supply of compressed air, clean water, grease oils and lubricants. Fuel for the mining fleet will be handled and stored at a fuel station adjacent to the mine truck shop which will include two 100 m³ horizontal diesel storage tanks.

18.1.13 Light Duty Truck Shop

Approximately 45 vehicles and light duty pieces of equipment will require repair and maintenance. An uninsulated, three-sided steel walled shop of approximately 330 m² will be utilized for light duty vehicles and will include one vehicle service bay, a lunchroom, a washroom and an office. The eave height of the light duty shop will be approximately 6 metres.

18.1.14 Fuel Storage and Dispensing

The main diesel storage facility will consist of one project owned 100 m³ storage tank. This facility will be complete with fuel dispensing systems and will be located near the mine truck shop. An additional fuel station with a 15 m³ storage tank will be centrally located to supply gasoline for light duty vehicles. Fuel will be delivered to the mine site via tanker trucks. All storage tanks will be placed in a 110% capacity concrete containment to assure no fuel is leaked to the environment.

18.1.15 Warehouse and Fenced Laydown Yard

A warehouse and laydown yard for storage of miscellaneous equipment, piping and supplies will be located near the entrance to the property. A 330 m² uninsulated, steel walled warehouse will have two rollup doors and include a washroom, a break room, two offices and all required firewater supply systems. The building has an open storage area for racking shelves and bins. An attached 260 m² fenced laydown yard will be adjacent to the warehouse. An additional 1-hectare unfenced area behind the warehouse is designated for additional laydown capacity.

18.1.16 Magazine Site

Within a two-metre high bermed and fenced area for explosives, there will be three ventilated silos and two CMU brick explosive magazines, two silos designated for ANFO storage and one silo for emulsion. The explosive storage silos will have a combined capacity of approximately 200 tonnes of explosives. Two silos of approximately 62 m³ and a third silo of approximately 33.5 m³ will be used to store ammonium nitrate and emulsion, separately. Depending on the seasonal conditions, emulsion and ammonium nitrate storage will vary from silo to silo.

A 550 m² CMU brick powder magazine will be used to store accessories and low explosive products, such as ANFO, emulsion packaging, boosters and detonation cord. A smaller 60 m² magazine will be used to store the detonators and will have a berm that separates it from the silos and the larger magazine.

Approximate distances from notable infrastructure are as follows:

- 800 metres northwest of the heap leach boundary
- 1000 metres west of the nearest occupied facility (primary crusher)
- 1100 metres southwest of the main haulage road
- 1200 metres west of the waste rock dump
- 1300 metres east of the El Berrendo access road

All of the above distances exceed the minimum safety distance requirements of the explosive regulations established by Secretaría de la Defensa Nacional (SEDENA) based on the amount of explosives to be stored in the explosives' facilities.

Security of the explosives' magazine will be conducted by strict authorization and documentation of all personnel entering the storage area for supply or removal of materials within the facility.

18.1.17 Guard Shack and Security

Access to the Camino Rojo Project will be limited to one main gate to access process and camp areas, ensuring only authorized employees, contractors and visitors are allowed onto the property or inside the critical facilities. The entrance will be manned 24 hours a day, 7 days a week for identification control, random checks, drug and alcohol monitoring and vehicle check-in/out. A security contractor will be used for general site security and protection of mine assets.

18.1.18 Medical Clinic

A 75 m² insulated CMU brick and stucco finished medical clinic and ambulance will be present onsite, near the administrative buildings. Emergency medical staff on site include one physician,

one paramedic, one nurse and one driver/rescue person. Medical treatment will be limited to the attendance of minor accidents and stabilization of patients that have received minor trauma. In the event high level medical care is needed, the ambulance is equipped and prepared for emergency transport to Saltillo or Zacatecas.

18.1.19 Fenced Areas

Approximately 6 kilometres of usable fencing around the property is already constructed. An additional 30 kilometres of fencing is required to isolate the Project and ensure safety and security. Chain-link fence and gated entry will be utilized around the explosives' magazines and process ponds area. Chain link fencing will be constructed around fenced laydown yards, sample storage areas and the camp facilities.

18.1.20 Airstrip

The Project infrastructure includes a one-kilometre by 30 metre air strip to allow for small passenger planes to land and take off at the Project site. The air strip will be constructed by grading and compacting the existing surface and is located south of the heap leach pad. The air strip does not include any infrastructure or provisions for fueling or maintenance of planes or other aircraft. The air strip will be located approximately 700 metres south of the event pond.

18.2 Power Supply, Communication Systems & IT

18.2.1 Power Supply

Power supply to the Camino Rojo Project will be by connecting to the national commercial grid. A new powerline to site is 49% complete. Overhead powerlines will connect the 34.5 kV, three phase and 60 Hz power system, to a metering and switching substation located at approximately NAD27 245609E, 2674826N.

An existing 34.5 kV powerline with concrete poles from San Tiburcio to El Berrendo accompanies the existing dirt road access to El Berrendo. This powerline and accompanying poles will be removed once new lined power is completed along the new El Berrendo access road around the Camino Rojo property. The new powerline from San Tiburcio to El Berrendo will be 34.5 kV, three phase and 60 Hz and will be constructed with concrete poles.

18.2.2 Site Distribution

Power distribution around the process plant and facilities will be by overhead powerlines at 34.5 kV, 3 phase, 60 Hz and will be stepped down to 4,160 V, 460 V, 220 V and 110 V as required. Power will primarily be supplied at 460 V or 220/110 V to motor control centres or distribution panels in their respective areas. Power to the conveying stacking system will be supplied at 4160

V and stepped down to 460 V using on board transformers for each conveyor. All overhead distribution powerlines will be connected to the main switchgear.

18.2.3 Estimated Electric Power Consumption

The estimated electrical power demand for the life of the Project is presented in Table 18-2, not including pit dewatering. Attached power for pit dewatering is estimated at 300 kW with demand varying based on pit dewatering requirements.

**Table 18-2
Power Demand**

Area / Description	Phase 1		Phase 2		Phase 3	
	Attached Power (kW)	Average Demand (kW)	Attached Power (kW)	Average Demand (kW)	Attached Power (kW)	Average Demand (kW)
Area 110 - General	410	231	410	231	410	231
Area 113 - Crushing	2545	1432	2545	1432	2545	1432
Area 115 - Heap Leach Stacking	2920	1752	3251	1888	3582	2025
Area 120 - Heap Leach Pad & Ponds	1216	865	1216	865	1216	865
Area 128 - Merrill-Crowe	464	325	464	325	464	325
Area 131 - Refining	367	150	367	150	367	150
Area 134 - Reagents	42	23	42	23	42	23
Area 360 - Power	10	6	10	6	10	6
Area 362 - Water Supply & Distribution	411	168	411	168	411	168
Area 365 - Laboratory	470	264	470	264	470	264
Total	8,855	5,216	9,186	5,352	9,517	5,489

Note: Minor Difference in Totals Due to Rounding

18.2.4 Emergency Power

In the event of a power failure or power interruption, diesel-fired backup generators will be used to supply emergency power for project safety and security. Backup electric power will be supplied to the following facilities:

- Critical process equipment including solution handling equipment
- Mine Camp
- Raw Water Pumping System

In order to maintain power to critical equipment during power outages, a 6,000 kW generator plant will be installed next to the main switch station. A fuel tank will be provided for the generator to maintain a 24-hr fuel supply. The fuel storage system will also include a concrete containment area sized for 110% of the capacity of the tank(s).

Emergency power for the mine camp and raw water pumping systems will be by small local generators located at the facilities.

18.2.5 Communications

Communications systems required to support mining, processing and general administration activities will require multiple transmission modes for fail-safe redundancy. Internal communications will be by radio frequency. External communications will be through a mix of landline, cellular and VOIP. Primary communications and any required equipment will be located within the server room in the administration building.

18.3 Water

18.3.1 Water Supply

Camino Rojo will require water for the following uses:

- Construction activities
- Dust control for mining and crushing activities
- Makeup water for the heap leach
- Process plant and laboratory activities
- Man camp and administration uses
- Fire water

Total project water supply will be sourced from production wells located within the property boundary. Total water consumption for the Project will average 24 L/s with a peak water demand of 33 L/s.

A production well designated CRPW-01 has been drilled approximately 2.7 km from the raw water tank. A seven-day pump test of PW-1 concluded that the well could produce at 24 L/s, without significant draw down and potentially up to 32 L/s. This is enough to supply water for operations in a normal year. Work is currently in progress to locate an additional production well to supplement water production at PW-1.

Pumping from production wells will likely be reduced commensurate with the amount of additional produced water from dewatering operations that will eventually replace the pumping. This is anticipated to begin in Year 5 of operations. The dewatering volume is expected to increase with pit depth and may eventually exceed the water demands for process and mine operations. The excess water from dewatering operations will likely require either evaporation by additional dust control or mechanical evaporators, or disposal by other methods.

The design basis for water supply for the average case are presented in Section 17.

18.3.2 Potable and Domestic Water

Potable water will be treated by a reverse osmosis water treatment system from the raw water tank and stored in an HDPE or lined storage tank to ensure that the water remains acceptable for domestic uses. Water will then be distributed by pumps to the camp and other facilities.

18.3.3 Fire Water and Protection

Throughout the property, hydrants and sprinkler systems will be installed at appropriate locations. The fire water supply will be a designated portion of the raw water tank located near the camp facilities. The fire water pumps will be a pair of 100% duty pumps, one electrically driven and the other diesel driven, which automatically comes into operation when the electrical driven pump is either being maintained or there is a power failure. To ensure a constant pressure in the main, an electrically driven jockey pump will also be utilized.

The entire system will be automated and provided with signals and alarms to communicate with the main control room. Fire alarm detection systems will be provided for all process areas, camp, warehouses, offices, workshops and electrical/control rooms. The fire detection system will consist of addressable intelligent automatic detectors, manual alarm stations and alarm bells within each facility tied to a central monitoring panel or to a local fire alarm panel with remote reporting to the central monitoring panel in the security office.

An underground network of HDPE pipe will feed fire hydrants located in proximity to all facilities and processing areas. Fire hose stations will be installed in the mine workshop, process plant workshop and in proximity to all major process areas.

18.3.4 Surface Water Management

Water runoff from upstream of developed property will be diverted around the mine operations and allowed to return to natural drainage locations on the southern boundary of the property. The details of this water diversion channel are outlined in the NewFields' report "Diseño Conceptual de Manejo de Aguas Pluviales y Control de Sedimentación". An emergency pond will collect water runoff from areas near the process facility through a series of diversion ditches. Ditches around ponds, stockpiles, buildings and roads will collect water runoff from developed portions of the property which will be conveyed to the channel detailed in the NewFields' report which is referenced in Section 27 of this Technical Report.

18.4 Sewage

A sewage treatment plant of 40 m³/day capacity will be constructed early in the construction phase next to the operations camp. This plant will handle the sewage from all camp rooms, kitchens and laundry rooms. Sludge volume generated in the treatment plant will be collected and utilized for compost production to be sent to the growth media stockpiles while the treated water will be utilized for dust suppression.

Waste from the septic systems of the process area, administrative buildings and laboratory will be collected in septic holding tanks and removed from the site by sanitary services. Septic tanks designated for the administration and contractor office buildings will be 20 m³ and all other associated tanks will be 10 m³ all of which will be serviced on a weekly basis.

19.0 MARKET STUDIES AND CONTRACTS

No market studies were completed and no contracts are in place in support of this Technical Report. Gold and silver production can generally be sold to any of a number of financial institutions or refining houses and therefore no market studies are required.

It is assumed that the doré produced at Camino Rojo will be of a specification comparable with other gold and silver producers and as such, acceptable to all refineries.

Gold and silver produced by the Camino Rojo Project would be sold to refineries or other financial institutions and the settlement price would be based on the then-current spot price for gold and silver on public markets. There would be no direct marketing of the metal. The base case financial model for the Camino Rojo Project utilizes a gold price of US\$1,600 per ounce and a silver price of US\$20 per ounce. The base case gold and silver prices have been selected based on forecasted commodities pricing with consideration to the three-year trailing average.

This Technical Report assumes that mining operations will be conducted by contractors working under the supervision of the chief mining engineer. The required contracts are:

- A general mining contractor,
- A blasting agent/high explosives manufacturer that will also be responsible for delivering the blasting products to the site, loading the blast holes and detonating the blasts,
- A specialty drilling contractor to drill small diameter holes for pre-splitting final pit walls and drilling holes for slope reinforcement if the general mining contractor cannot perform these tasks.

Quotations for these services have been received and were used to estimate costs for the Feasibility Study, but no contracts are currently in place.

20.0 ENVIRONMENTAL STUDIES, PERMITTING AND SOCIAL OR COMMUNITY IMPACT

20.1 Environmental Studies

Some baseline environmental studies were completed by previous operators of the Project. In April 2018, Orla commissioned independent consultants to conduct more complete baseline environmental studies over the Project area. The studies required to support permitting were completed in May 2019. Periodic sampling of some parameters such as groundwater and air quality is ongoing.

20.1.1 Project Area Description

The description of the Camino Rojo Environmental System (Sistema Ambiental) presented in this Technical Report has been summarized from the Technical Justification Study for Change of Land Use (ETJ, Estudio Tecnico Justificativo para Cambio de Uso de Suelo) prepared for submission to the Federal environmental permitting authority SEMARNAT.

20.1.1.1 Climate

The climate is typical of the high-altitude Mesa Central, dry and semi-arid. Temperatures commonly range from +30° to 12 °C in the summer and 24° to -6° C in the winter. The median annual temperature is 17.1 °C. The average annual precipitation of 337mm falls mostly during the rainy season in July, August, and September. The average annual evaporation is approximately 1,900mm. Wind speeds are variable with maximum wind speeds of 130 to 160 kph during extreme events. Average wind speed is 5 kph.

20.1.1.2 Soils

Soils are dominantly calcisols (soils with high carbonate component) and leptosols (shallow soil over carbonate rock). These soils are not very suitable for agriculture.

20.1.1.3 Hydrology

The Project is located in Hydrologic Administrative Region III, North Central Basins, in Hydrologic Region Number 37 El Salado, within the RH37C Sierra de Rodriguez Basin, within sub basin RH37Ca San Tiburico and micro-basin 37-158-04-007 San Tiburcio, characterized by open dendritic drainages.

20.1.1.4 *Physiography*

The Project is located in the Mesa Central physiographic province, dominated by gently sloping valley floor lowlands in basins separated by low hills and/or moderate relief mountains.

20.1.1.5 *Seismicity*

The site is in Seismic Zone A, nil to very low seismic activity: It is characterized by zero reported historic seismic events and expected temblor-caused soil accelerations of no more than 10% of the acceleration of gravity

20.1.1.6 *Vegetation*

The vegetation is dominantly creosote bush and tar bush, with cacti, maguey, sage and coarse grasses with rare yucca, and is classified as matorral desértico micrófilo (small leaved and/or thorny desert scrub less than 4m high) which covers >95% of the Project area, and matorral desierto roseto fillo (desert scrub less than 4m high with rosette shaped leaves) which covers <5% of the Project area).

Five flora species with legally protected status are present: biznaga (beehive cactus - *Coryphantha delicata*); biznaga burra (giant barrel cactus - *Echinocactus platyacanthus*); biznaga barril de lima (Mexican fire barrel cactus - *Ferocactus pilosus*); biznaga bola uncinada (Chihuahuan fishhook cactus - *Glandulicactus uncinatus* ssp. *Uncinatus*); and amole cenizo (*Manfreda potosina*).

In addition to the protected species, the independent biologists contracted to conduct the flora survey recommended that eleven flora species be considered of biological interest and included in a flora rescue/protection plan.

In accordance with Federal laws and permit conditions, 100% of protected plants will be rescued and transplanted prior to construction. The planned program of flora rescue and transplant anticipates the collection and transplantation of 3,801 plants of protected species. Additionally, 10% of the plants of biological interest will be rescued and transplanted prior to construction. The total number of plants of biological interest to be rescued and transplanted is estimated at 8,502. A nursery will be constructed on site to safely store rescued plants prior to their re-planting, and native vegetation seeds will be collected and germinated in the nursery to provide plant stock for post-closure reclamation plantings.

20.1.1.7 *Fauna*

Seventy-eight vertebrate species were identified in the Project area, 57 bird species, 9 mammals, 8 reptiles, and 4 amphibians. Nine species identified in the Project area are listed as threatened or protected species, and thus require special consideration: sapo verde (North American green toad - *Anaxyrus debilis*); cascabel de diamantes (Western diamondback rattlesnake - *Crotalus atrox*); vibora de cascabel gris (rock rattlesnake - *Crotalus Lepidus*); víbora de cascabel cola negra (black tailed rattlesnake - *Crotalus molossus*); chirrionera (coachwhip snake - *Masticophis flagellum*); culebra sorda Mexicana (Mexican bull snake – *Pituophis deppei*); lagartija espinosa de mezquite (mesquite lizard - *Sceloporus grammicus*); zorra norteña (kit fox - *Vulpes macrotis*); and the aguililla rojinegra (Harris hawk - *Parabuteo unicinctus harrisi*).

In accordance with Federal laws and permit conditions, prior to construction qualified biologists will survey areas to be disturbed to identify nesting areas, dens, and lairs of animals present. Any animals not naturally prone to leave the area that are found will then be relocated to suitable habitats elsewhere in the property area.

20.1.2 Environmental Management Plans

A key objective is to design and build the Project in such a way that it does not cause significant adverse effects during construction, operation, closure and post-closure. To aid this objective, a number of Environmental Management Plans were developed prior to the start of construction. An outline of some of the key plans is given in this section. These plans will need to be developed further before construction begins. They will also need to be reviewed and revised during the life of the Project.

Costs for environmental monitoring, management plans and environmental protection measures are included in this Technical Report.

20.1.2.1 *Surface Water Management*

Surface waters in the Project area are exclusively ephemeral streams with water flow only during storm events, and small retaining ponds built along the drainages as sources of water for livestock and agriculture. As part of Project environmental baseline studies, water from retention ponds was sampled. Sampling of surface waters draining the Project area will be continued through the life of the mine, including reclamation period and post-closure until it has been determined that reclamation has been successful in preventing long-term effects on surface waters.

Water diversion structures will be constructed to keep surface water from flowing into the heap leach pad, mine pits, waste dumps and other operational areas. Surface drainage from disturbed

areas which have no potential to produce chemical or metal contamination will be directed into small ponds to allow sediments to settle out before discharging to the environment.

Independent consultants have completed a detailed investigation of Acid Rock Drainage (ARD) and metal leaching potential. Over 80% of the mineralized and unmineralized material that would be moved or processed under the plans described in the Feasibility Study are categorized as Non-Acid Generating, the remaining material is categorized as Potentially Acid Generating. The waste rock storage facility and the heap leach pad are expected to be net neutralizing. A full report of the ARD study by HydroGeoLogica is referenced in Section 27 of this Technical Report. A preliminary waste rock management plan has been developed by HydroGeoLogica and includes encapsulating potential acid forming materials in the centre of the waste rock storage facility to limit the possible generation or release of ARD as described in Section 16.6.

20.1.2.2 Ground Water Management

Groundwater in the area of the proposed pit and waste rock storage facility (WRSF) is present at approximately 110 metres (m) below ground surface (bgs), indicating a significant unsaturated zone is present underneath the WRSF. Groundwater in the vicinity of the heap leach pad (HLP) has been encountered at depths of 12 to 27m bgs and a northerly groundwater gradient toward the mine pit has been established (Figure 24.2 and Figure 24.3) using data from the groundwater monitoring wells constructed around the HLP.

Groundwater is not currently used as water supply in the vicinity of the Project and the groundwater quality precludes its use for drinking water as concentrations of several constituents are above drinking water standards. Groundwater in the vicinity of the WRSF, based on water quality samples collected from long-term pumping test of well CR-01 in January 2019, has a near neutral pH, but high total dissolved solids (TDS) in the range of 5,000 to 6,000 mg/L, as well as elevated concentrations of other constituents. Additionally, water from CR-01 had an arsenic concentration of 0.27 mg/L in one of the January 2019 samples, greater than standards applicable to the Project (average monthly discharge standards for agriculture presented in NOM-001-SEMARNAT-1996).

Groundwater quality degradation could potentially come from the heap leach pad and associated ponds (if the liners leak) and from the waste rock dump. Therefore, monitoring wells will be constructed down-gradient of the heap leach pad, mine and waste rock dumps. A systematic sampling program will be developed to ensure any effects the operation has on groundwater are detected and appropriate changes to the operation can be made to negate these effects.

Hydrologic models of the proposed mine area indicate that post closure, the mined pit would become a pit lake with evaporation exceeding inflows, thus the pit would become a hydrologic

sink relative to lateral groundwater flow and groundwater in the vicinity of the pit would flow towards the pit, thus minimizing the potential for affecting groundwater quality outside of the immediate mine area. However, stabilized pit lake levels may be higher than heads in deeper formations, creating a potential for movement of water from the pit lake into those deeper formations.

20.1.2.3 *Air Quality Management*

The primary potential effect on air quality will be because of dust. Costs for watering the road and for dust control in the crushing circuit have been included in this Technical Report. The Company has an ongoing air quality monitoring program in local communities. An air quality monitoring program will be initiated to ensure worker health and the environment are not adversely affected by air quality.

20.1.2.4 *Flora and Wildlife Management*

In accordance with Federal laws and permit conditions, 100% of protected plants and 10% of the plants of biological interest will be rescued and transplanted prior to construction, as described in Section 20.1.1.6 of this Technical Report. All protected species of fauna will be rescued and relocated to suitable habitats prior to commencement of operations as described in Section 20.1.1.7 of this Technical Report. All operational areas will be fenced to keep animals out. A no hunting policy will be enforced amongst workers. Waterfowl are not common in the area. However, if required, a system to keep birds from landing in the operational ponds will be devised.

20.1.2.5 *Soil Management Plan*

Orla will stockpile soil removed during construction for use in future reclamation as described in Section 20.1.4.1 of this Technical Report, and Orla will adopt construction best practices to minimize soil erosion during mine construction and operation.

20.1.2.6 *Cyanide Management Plan*

Orla will develop a cyanide management plan which will include measures to prevent interaction of wildlife with heap leach solutions. All lining and containment systems will be designed to meet International Cyanide Code requirements and will be constructed according to North American standards.

20.1.2.7 *Waste Management Plan*

Orla is developing waste management plans in accordance with Mexican regulations and are designed to minimize the creation of wastes and residues, as described in Section 20.1.3 of this Technical Report.

20.1.2.8 *Environmental Monitoring Program*

During construction and operation, Orla will monitor groundwater, surface water, soil and air quality, and will monitor performance of all mine and plant operations to ensure compliance with mitigation procedures prescribed in the operating permit.

20.1.3 Waste Handling

20.1.3.1 *Hazardous Wastes*

Special wastes such as waste oil, glycol coolant, solvent fluids, used oil filters, used batteries, and contaminated fuel, will be handled, stored, transported, and disposed of in accordance with appropriate Hazardous Waste Regulations. A certified transport and disposal company will collect all waste to transport offsite for final disposal.

The fenced temporary storage facility for hazardous waste will be approximately 1,375 m². Approximate 7.5 m² of steel roofed storage area will be designated for used batteries and 50 m² of storage for used lubricants, coolant and other miscellaneous fluids. Approximately 730 m² within the fenced area is designated for used tires. This area is sized for a year of replaced haul truck tire storage stacked one tire high, providing additional storage if tires are stacked in multiples.

20.1.3.2 *Non-hazardous Wastes*

A site for temporary storage of recyclable materials will be established at the laydown Area. Such items as scrap metal, tires, glass, recyclable plastics and drink containers will be separated, containerized as appropriate, and temporarily stored in the lay down area until sufficient volumes are available for shipment to a recycling point. Non-recyclable and non-hazardous waste will be buried in an on-site fenced landfill of approximately 12,000 m². The landfill will have the capacity for approximately 15,000 m³ or 4,500 tonnes worth of waste material based on a compaction of 300 kg/m³, the minimum landfill compaction outlined in NOM 083.

20.1.3.3 *Putrescible (Domestic) Waste Disposal*

Non-hazardous putrescible organic food wastes generated from the camp accommodation facilities will be composted and used as an organic enrichment to stockpiled soil, or if not suitable for composting, will be buried in the landfill site along with other inert non-recyclable materials.

20.1.3.4 *Boneyard Storage*

A location on the mine site will be designated as an outdoor storage or 'boneyard' area for placement of items that are not yet ready for disposal, but which may still be of use for spare

parts. These items are likely to include equipment parts, vehicles, and pieces of equipment, and metal components. As much of this material as possible, will be utilized during the mine life. Materials remaining in the boneyard at the end of mine life will either be shipped off site for salvage value, recycled, or disposed of in the landfill if they meet the criteria for disposal at that location.

20.1.3.5 *On-site BioRemediation Cell*

“Land farming” is a commonly used method of soil remediation for hydrocarbon contaminated soil that relies on natural breakdown of hydrocarbons by microbial action. This is done by spreading a shallow layer of contaminated soil onto a lined "bermed" area referred to as a biocell. In the event of a minor hydrocarbon spill on site, the contaminated materials will be treated using a biocell as authorized in the Hazardous Waste Regulation.

20.1.3.6 *Waste Water (Sewage) Disposal*

The wastewater disposal systems for the camp and office areas will be engineered, constructed, and maintained under the direction of a qualified professional and will comprise separate septic systems for the office and housing facilities as described in Section 18.0.

20.1.4 Reclamation

Reclamation will be undertaken during mining activities where possible, but the majority of work will occur after the completion of mining and final gold recovery. The reclamation land use objective will be to return the land to its traditional use as a grazing area for goats and wildlife habitat. Closure objectives include securing the site to assure physical safety of people, protecting wildlife, protecting surface and groundwater quality and quantity, minimizing erosion and controlling fugitive dust. To accomplish these objectives, the following key elements will be included in the reclamation plan:

1. Chemical stabilization, accomplished through rinsing of the heap leach pad solutions, encapsulation of potentially acid generating rock in the waste rock storage facility, placement of a cover on the heap leach pad and development of a pit lake;
2. Physical stabilization, accomplished through slope grooming, and the application of topsoil and revegetation;
3. Control of surface waters; and
4. Monitoring effluent chemistry from the pad and water draining the mine waste and pit areas.

Closure will be accomplished in three stages:

1. Concurrent: measures implemented during the operating life of the Project;

2. Final: measures implemented after cessation of operations; and,
3. Post-closure: provides for short-term maintenance and long-term monitoring of the closed facilities.

An outline of the key components of the closure and reclamation plan is given in this section. Further detailing of these components will be required before construction commences. During operation, the closure and reclamation plan will be revised further.

20.1.4.1 *Soil Handling*

All topsoil harvested during construction will be stockpiled for future use. However, the site is expected to be deficient of organic matter and other soils to support revegetation. Therefore, during operations topsoil will be created. This will be done by combining compostable materials with suitable native soils and natural topsoil. The produced topsoil will be stockpiled for future use; this process must start early since green wastes require time to compost before they are suitable to use as soil amendments.

Possible sources for organic matter include:

- Chipped wood, bark and brush from site clearing activities (from the entire site including the mine and waste dumps), beginning with the initial site clearing and including subsequent phases of expansion of the heap, waste dumps and open pits;
- Composted organic fractions from solid wastes (especially food wastes) from the camp and canteen; and,
- Composted sewage sludge from the on-site disposal systems (ideally composted with the solid waste organic fraction).

20.1.4.2 *Camp*

All camp buildings will be removed upon completion of the operation and the area graded and seeded.

20.1.4.3 *Central Operating Area*

Prior to reclamation, all hazardous material will be removed from site. All equipment and building in the central operating area, including the office and warehouse, mine truck shop, Merrill-Crowe plant, generators and fuel handling facility will be dismantled and removed, and the area graded and seeded.

20.1.4.4 Mine Pit

Closure of the pit will include restricting access to the pit and allowing the pit to naturally fill with groundwater to form a pit lake. In order to prevent the inflow of natural water runoff, the catchment berm preventing upstream flow into the pit will be retained after closure.

Hydrogeologic and geochemical modeling to predict pit filling and pit lake water levels and pit lake chemistry during the post-closure period was performed by HydroGeoLogica (HGL, 2020) and is presented in the report titled “Camino Rojo Pit Lake Evaluation Report, Unconstrained Case”. The pit lake is expected to fill to a steady-state elevation within 35 to 40 years. The steady-state pit lake is predicted to be approximately 148m deep with a lake surface 120m below the rim; discharge to surface water will not occur. The groundwater gradient in the vicinity of the pit will flow towards the pit, thus the pit lake is not predicted to affect surface or groundwater at the site. The pit lake water balance indicates that the pit will function as a hydraulic sink in the base case scenario and the sensitivity scenarios evaluated. The pit lake chemistry is expected to initially have a near-neutral to alkaline pH and a total dissolved solids concentration (TDS) that is elevated, but similar to that of groundwater (4500 to 6000 mg/L), increasing over time due to the effects of evaporation (evapoconcentration), reaching approximately 17,400 mg/L after 200 years. The predicted chemistry of the pit lake strongly reflects the influence of groundwater, the dominant inflow to pit lake. The resulting prediction is a saline, alkaline pit lake with some metals concentrations that increase through time due to evapoconcentration and the hydraulic sink effect. However, predicted concentrations of metals, with one exception, did not exceed standards referenced in NOM-001-SEMARNAT-1996 during the 200-year modeled period under the base case scenario and under the majority of the sensitivity scenarios that address model uncertainty or variance from the base case. Zinc concentrations were predicted to exceed standards under the base case scenario, but only following 180 years of evapoconcentration of the pit lake. The uncertainty and error associated with a prediction at an extended time in future is significant, and the model is not intended to provide precise predictions this far in the future. Rather, the model provides an indication as to potential concentrations, constituents of concern for monitoring, and expected geochemical trends. As such, the results indicate that monitoring of zinc and other metals that may evapoconcentrate is warranted during operations and pit filling and that continued evaluation of the geochemistry throughout operations is warranted.

This pit lake chemistry will contrast with local lakes that are fed by surface water which provide aquatic and terrestrial habitats and a potential water resource. The lake may provide some limited habitat in the form of salt tolerant vegetation, but it is unlikely that the pit lake will provide a useable water resource for aquatic or terrestrial wildlife or nearby communities due to the saline character of the pit lake water.

Water inflow and quality in the pit and surrounding areas will be monitored for 10 years after the notice to SEMARNAT of restoration compliance.

Finally, the pit will be enclosed by a perimeter fence in order to restrict the access of individuals and wildlife in the area.

20.1.4.5 Waste Rock Storage Facility (Mine Waste Dumps)

The WRSF and associated roads will be reclaimed post mining. Mine roads and waste dumps will be re-sloped, with slopes re-contoured to 2.5:1 horizontal to vertical grade, have topsoil added, and be re-seeded.

Short and longer-term monitoring of slope stabilities will be provided until deemed stable.

Sulphide oxidation is a potential issue for all mineral deposits containing sulphides that are exposed to air and water through the process of mining. Sulphide oxidation produces acidity that can result in acid rock drainage (ARD) if there is an absence of sufficient neutralization potential and if there is sufficient flushing to mobilize this acidity. However, if sufficient neutralizing minerals, specifically carbonate minerals such as calcite, are present and available, then acidic conditions may not occur even in the presence of sulphide oxidation.

Geochemical characterization and modeling studies completed by HydroGeoLogica Inc. (HGL, 2020) demonstrate that the Camino Rojo deposit has abundant neutralization potential throughout the deposit, with an average content of approximately 135 tCaCO₃/kt for all material types in or proximal to the proposed pit and approximately 185 tCaCO₃/kt for all samples associated with the deposit. The average acid neutralization potential (ANP) is slightly higher for the post-mineral and oxide samples (approximately 140 tCaCO₃/kt), and slightly lower for the transition and sulfide sample (approximately 130 tCaCO₃/kt). Additionally, the post-mineral and the oxide zones of the deposit have limited to no sulphide minerals, though the transition and sulphide zones of the deposits have low sulphide mineral contents, primarily as pyrite, with average contents of approximately 1 wt% and 3 wt%, for the transition and sulphide materials, respectively. These average sulphide contents correspond to acid generation potentials (AGPs) of approximately 33 to 103 tCaCO₃/kt, respectively, less than the average neutralizing potential.

Assuming an average ANP for the post-mineral and oxide materials of approximately 140 tCaCO₃/kt and the weighted sulfur contents from the block model to calculate AGP, there is more than ten times the required neutralization potential to balance acid generation and acid neutralization potential. Mexican regulations (NOM-157-SEMARNAT-2009) use the neutralization potential ratio, NPR, (ANP/AGP) for classification of waste materials, with NPR

values less than 3 designated as potentially acid forming (PAF). The weighted NPR value for the overall WRSF is 10, indicating overall non-acid forming (NAF).

Metals leaching from mine rocks may occur under neutral or acidic conditions. Neutral leaching occurs for metals and metalloids mobile at neutral pH values, such as arsenic, selenium, manganese, or zinc. If acidic conditions develop, leaching of additional metals, and generally at higher concentrations, will occur.

The bulk metals and metalloids content in the solids of waste materials provides an initial indicator as to metals leaching that may occur. However, an elevated metal or metalloid content does not necessarily mean that the constituent will be mobilized or mobilized at concentrations of environmental concern. Leach testing is required to evaluate metal mobility. Following this, NOM-157-SEMARNAT-2009 provides limits (límites máximos permisibles; LMPs) for metals and metalloids in solids and metals and metalloids in leachates from laboratory leach tests (LMPs for the PECT) to guide evaluation of a waste material. Based on the bulk metals and metals content of waste rock samples, arsenic, lead, cadmium, and antimony are consistently above the solid LMPs provided in NOM-157-SEMARNAT-2009 for the oxide, transition, and sulfide materials. Metals and metalloids were not above regulatory limits for the post-mineral material samples. However, leach testing of a subset of these oxide, transition, and sulfide materials did not result in any leachate exceedances of the NOM-157-SEMARNAT-2009 PECT LMPs, indicating that these metals and metalloids have limited mobility and may not be mobilized at concentrations of environmental concern. This included short term leach testing by the synthetic precipitation leaching procedure (SPLP) and long-term leach testing by humidity cell tests. Results indicate that leaching of cadmium, lead, antimony and arsenic is not expected to significantly affect surface or groundwater. Monitoring is recommended for confirmation.

A waste rock characterization and handling plan was developed by HydroGeoLogica, independent consultants to Orla, (HGL, 2020), key components of which are:

- Minimum 5-metre (m) thick base of oxide/post-mineral. This practise will: a) prevent direct infiltration of seepage from transition and sulphide materials to the vadose zone and groundwater, b) prevent surface water and/or groundwater moving along the waste rock-ground surface contact to interact with transition and sulphide materials, and c) provide a layer of material with excess neutralization potential at the base of the WRSF, which will provide attenuation capacity for any acidic seepage generated within the WRSF.
- Final surface of 3-m layer of post-mineral/oxide material. This will prevent long-term exposure of transition and sulphide materials and limit development of potential localized zones of acidic conditions.
- Management of transition and sulfide materials. Some of the transition and sulfide materials have a potential for ARD generation and increased metals leaching. As such,

management of these materials within the WRSF is recommended. The WRSF design includes segregation and encapsulation of the transition and sulfide materials in the interior of the WRSF to prevent exposure. An alternative option is to layer or blend transition and sulfide materials with post-mineral and oxide materials. However, given the mine plan and scheduling limits, it is expected that segregation, with later encapsulation, will be relied upon for the final years of the mine life when the majority of the transition and sulfide minerals are to be mined with relatively little to no post-mineral or oxide materials.

Additional components of the waste rock management in anticipation of closure and reclamation include: a water shedding design, including grading and sloping of lifts, benches and top surfaces to limit infiltration and prevent ponding, and water management structures to divert non-contact water around the waste rock storage facility. Runoff from the waste rock storage facility will be contained in retention or sediment control basins, as appropriate.

20.1.4.6 *Roads*

During reclamation, slopes on roads will be stabilized and any culverts removed. Drainage bars will be constructed to keep water from flowing down the road bed. Except for the access road, surfaces will be scarified and seeded.

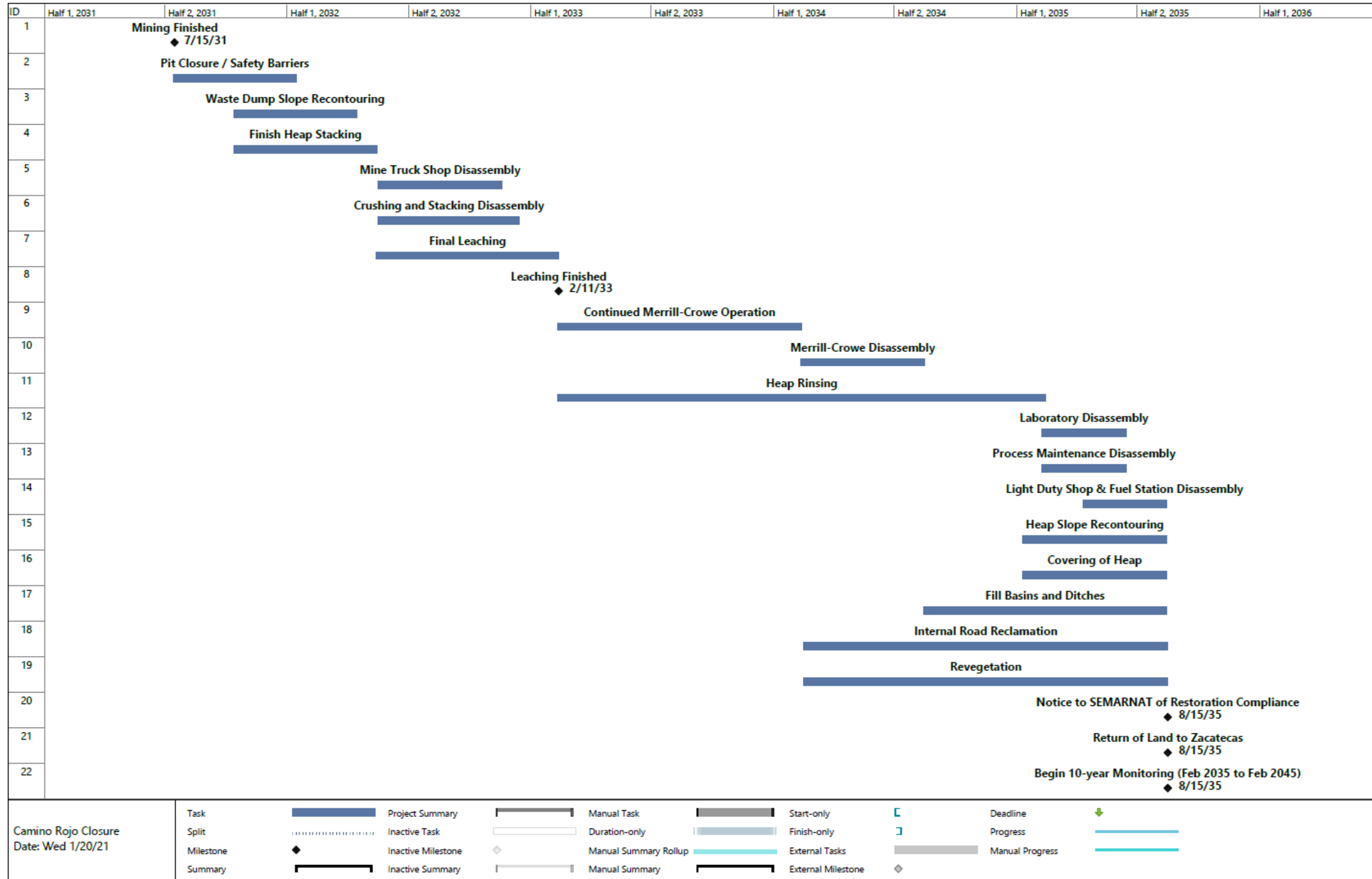

Figure 20.1 Camino Rojo Project Closure Schedule

20.1.5 Closure Activities – Heap Leach Facilities

The following activities will be completed during the operating life of the Project, beginning in year 3 of operations and continuing until the cessation of operations:

20.1.5.1 Chemistry

Analysis of results from geochemical and metallurgical laboratory testing to investigate heap neutralization and long-term chemical and physical stability of the heap leach has been completed by KCA and HydroGeoLogica Inc., and the results of these studies are herein summarized.

The HLP will contain oxide ore and transitional ore (TrH and TrL); as such, development of acid rock drainage (ARD) in the HLP during operations or the post-closure period is not expected. The environmental geochemical behaviour of the oxide and transitional materials for the deposit has been evaluated by several geochemical characterization programs, as summarized by HGL (2020a). The oxide materials are non-acid forming, with low sulphide content and abundant acid neutralization potential (ANP). The transitional materials are also considered overall non-acid forming due to their abundant ANP. However, the transitional materials have variable sulphide mineral content due to the variability of oxidation in the deposit, resulting in a potential acid-forming classification for approximately 30% of the transitional samples (HGL 2020a) based on Mexican standards.

The sulphide mineral content of the ore is important from a metallurgical standpoint because it affects cyanide leaching, and from an environmental standpoint, because it determines the environmental behaviour with respect to ARD potential (HGL 2020a). The predicted annual average total sulphur content of the ore, based on assay data and the block model, was included in the mine schedule IMC (2019b). Given that the majority of the ore is oxide, the overall sulphur content is relatively low at 0.59 wt%, which has an equivalent acid generation potential (AGP) of approximately 18 tonnes of calcium carbonate per kiloton (tCaCO₃/kt). In contrast, the average neutralization potential (NP) for the oxide and transitional ore samples as presented in HGL (2019a) was 72 t CaCO₃/kt, ranging from 19 to 163 t CaCO₃/kt.

The resulting net neutralization potential (NNP, defined as the NP minus the AGP from sulphur content as pyrite), considering respective tonnages of oxide and transitional ores, is overwhelmingly positive, with an excess of 3.6 million t CaCO₃, due to the relatively elevated ANP of all materials and the abundance of low-sulphur oxide materials.

Mexican regulations (NOM-157-SEMARNAT-2009) use the neutralization potential ratio (NPR; ANP/AGP) for classification of waste materials, with NPR values less than 3 designated as potentially acid forming. Weighted annual average NPR values were calculated for the overall ore. The NPR values are greater than 3 except for the final two years of mining when the ore is

mostly transitional ore; however, this only represents approximately 15% of the overall ore based on the mine plan. Using the bulk ANP and AGP for the HLP, the overall HLP is classified as non-acid forming with an NPR of 3.9.

The metals leaching behaviour of the oxide and transitional leached ore was evaluated using column tests completed as a part of metallurgical testing and through short-term leach testing using the synthetic precipitation leaching procedure (SPLP). The metallurgical column test rinsing included chemical analysis of rinse leachates over time from free-draining columns containing approximately 200-kilogram (kg) samples. Six of the columns were rinsed by drip irrigation with water or with a detoxified barren solution with the equivalent of 5 to 8 pore volumes of rinse solution.

Concentrations of metals and cyanide decreased with rinsing, and by pore volumes 5 to 8, concentrations of all metals and cyanide, with the exception of arsenic, were below standards applicable to the site as presented in NOM-001-SEMARNAT-1996 (metals limits for discharge for agricultural use) and NOM-155-SEMARNAT-2007 (cyanide limits for heap leach mining).

Arsenic concentrations were also elevated in the SPLP tests (though not relative to the standard applicable to the tests, NOM-157-SEMARNAT-2009, for determination of hazardous materials), as well as in one of the humidity cell tests on the oxide waste rock (HGL 2019a). The combination of these results imply that the source of the arsenic is not due to cyanide leaching, but rather weathering of the oxide and transitional ore. Given this, the elevated concentrations of arsenic observed in the rinsing are expected to persist long term in the post-closure period. Consistent with this evaluation, arsenic is also elevated in the natural groundwater based on sample testing of well CR-01 in the pit area (Section 20.1.2.2). Designs and procedures developed to ensure the elevated arsenic does not result in environmental degradation are given in the following sections.

20.1.5.2 Permanent Surface Water Diversion Works

As the leach pad expands the lower portions of the surface water diversion systems will be in their final locations, and then they will be upgraded to meet permanent standards for erosion and storm size appropriate for the post-closure period to limit maintenance. This will also apply to the outlet structures and any associated erosion works.

20.1.5.3 Permanent Slope Stabilization

Once heap slopes are in their permanent configuration and leaching has ceased, final grooming, capping and revegetation of these slopes, along with associated surface water and erosion controls, will be implemented.

20.1.5.4 *Final Engineering and Monitoring Plans*

The plans developed during concurrent closure will require final revisions to accommodate both lessons learned and the final configuration of the heap and roads. This will also include final as-built surveys of the facilities.

20.1.5.5 *Heap Rinsing, Neutralization and Solution Management of HLP Seepage*

The heap rinsing process consists primarily of recirculating cleaner water through the heap. Initially the recirculated solutions will be process solutions, diluted by normal rainfall, with pH buffered to normal leaching levels to allow complete extraction of gold, silver and other metals. Individual areas of the heap, simulating approximately the normal leach areas, will be rinsed so that the capacity of the drainage system and plant are properly utilized. Once the target levels for the controlled constituents (pH, metals and CN) are reached, the heap will be allowed to sit idle through at least one wet season and the effluent chemistry monitored to ensure the targets are maintained. If any of the constituents exceed the targets, then rinsing will be repeated.

Following rinsing, the HLP may be regraded as needed and a cover will be placed on the HLP to reduce infiltration and subsequent seepage that may require management. The HLP will initially have a high moisture content from residual rinsing and leaching solutions. During initial drain down of these solutions, flows will be similar to that of operations, but will decrease rapidly as the coarser zones are drained. Following the bulk of draindown, seepage rates will approach those of a long-term, steady-state seepage. Long-term seepage rates will be governed by precipitation, evaporation and the cover system.

Geochemical testing of residual samples from column leach tests indicate that leached material is not prone to acid production and the potential for metal leaching is generally low. Long-term seepage chemistry is expected to be similar to that of the final rinses from the metallurgical columns, near-neutral to alkaline with low concentrations of metals with the exception of arsenic. The long-term seepage is expected to be low with the use of a cover, less than 0.2 L/s, but will likely persist in perpetuity and may be sporadic. The long-term seepage can be managed using the operational solution collection system and directed to an evaporation pond constructed by the conversion of the operational ponds, eliminating the need for discharge.

In the first years of operation detailed closure and monitoring plans will be developed considering the as-built facilities and the projected as-stacked heap. These plans will be of sufficient detail to allow the start of concurrent closure activities as well as planning for final closure.

Laboratory and field data will be collected on an ongoing basis to support geochemical and heap neutralization modeling and to allow accurate prediction of both the neutralization process and effluent chemistry following closure. Laboratory testing may include leach columns and kinetic

testing to simulate long-term geochemistry. Field testing may include testing either pilot heaps or cells created inside the commercial heap to verify the laboratory data. Geochemical modeling will allow predictive modeling of effluent quality from the closed heap.

20.1.5.6 Heap Slope Grooming and Slope Stabilization

After the heaps have been rinsed and neutralized, the slopes will be graded to a smoothed contour with 2.5:1 horizontal to vertical grade, with appropriate grading to promote proper drainage and to accommodate the cover. In some cases where slope stability has been an issue during operations, some flattening of the slopes may be required as part of final closure. The required final slopes will be determined based on testing and analysis. Some areas may be graded to allow creation of permanent access roads or other features. The lower portions of the entire perimeter of the heap will be graded so that all exposed liner is covered but such that the liner will still capture draindown and seepage solutions for short term and long-term water management.

20.1.5.7 Cover, Topsoil Placement and Revegetation of Heap and Surrounding Areas

The heap, as well as any disturbed ground in the vicinity (except roads and diversions to remain) will be covered with an evapotranspiration cover of native soil, growth media (topsoil), supplemental nutrients as needed, and then seeded. The cover will provide for protection of surface water runoff quality, limit infiltration into the HLP, reducing post-closure water management requirements, and promote vegetation growth. For high-erosion prone areas some rapid growing, annual species of exotics may be used but the revegetation plan will emphasize the use of locally harvested native species. Experience has shown that locally harvested seeds have the highest survival rates and are the best suited to local soil and climate factors. Over the heap non-food species will be preferred to avoid accumulation of any metals in the food chain. The cost estimate includes harvesting and purchasing seed and purchasing fertilizer annually for the first three years; afterwards the maturing vegetation will generate sufficient seed and organic mass to support robust growth.

20.1.5.8 Ponds and Pump Stations

The solution and emergency ponds and pump stations will remain in place and in service for the first few years after operations cease to allow management of heap effluents. Upon determination they are no longer necessary, they will be removed.

20.1.5.9 Physical and Mobile Equipment

Except for a handful of light mobile equipment (truck, backhoe, bulldozer), no equipment form mining activities will remain on-site. Most of the removed equipment will be in serviceable condition and thus will probably be sold at a profit (i.e., sales proceeds exceed decommissioning

costs). Equipment not saleable as functioning equipment will be recycled, sold for scrap, or suitably disposed of.

20.1.5.10 Roads, Diversion Works and Erosion Controls

Roads and diversion works that are to remain in service post-closure will be upgraded to meet the closure design. Generally, this will mean that the surfacing will be more robust and that the dimensions of drainage facilities will be enlarged to meet a larger design storm. Culverts will be replaced with surface crossings since culverts are only serviceable for 10-20 years.

20.1.5.11 Fencing

All fencing around the pad and pond areas will be removed as the land is intended to return to grazing and wildlife habitat. Permanent fences will remain around the pit and the evaporation pond.

Fencing will be removed to allow for grazing wildlife habitat. However, fencing will be maintained around the pit to prevent access to the pit and around evaporation ponds near the HLP.

20.1.6 Post Closure Activities

20.1.6.1 Physical Monitoring and Maintenance

After the completion of final closure, the site will require regular maintenance for the first approximately 10 years post-closure or until there is no further signs of changing conditions. During this period, the site will be inspected every calendar quarter (3 months) and maintenance activities will be planned immediately following each wet season and following any unseasonal major storm events. The purpose of this is to ensure the drainage and erosion control measures are working as planned, and to allow the recently revegetated areas to mature and properly take hold. Maintenance work will consist of light manual labour (ditch tending, rubble removal, and so forth), and light equipment (backhoe and bulldozer) work to regrade or groom any areas showing signs of distress or erosion.

Once the site stops showing signs of seasonal distress and the functionality of the facilities has been field proofed, and when the geochemical performance matches predictive modeling, periodic inspection and maintenance activities can be reduced in frequency; initially to annually and eventually to only after unusually high rainfall periods.

20.1.6.2 Geochemical Monitoring and Maintenance

The quality of the water draining from the heap will require monitoring and comparison to the predicted chemistry and discharge standards. If the measured water quality significantly varies

from that predicted, in an unfavourable manner, then the geochemical model will be revised and new forecasts prepared. In the extreme case additional rinsing and neutralization of the heap may be required. More likely it will only be required to extend the short-term maintenance period.

During the initial, short-term draindown period, the ponds will remain in service for water management. Water collected in the ponds will be tested with each inspection cycle and if the water quality does not meet discharge standards then that water will be recirculated to the heap and/or evaporated. No discharge of solutions are expected. The ponds will likely accumulate sediments and precipitates as water accumulates and evaporates. These sediments will require periodic removal and can be buried within the heap. This will probably continue for at least one-year post-closure and may be needed for up to five years, depending upon the effectiveness of the erosion control measures and re-vegetation efforts.

In the long term, the ponds will be used for evaporation of HLP seepage as described in Section 20.1.6.4 for surplus water management. No discharge of solutions are expected. Sediments and evaporative precipitates will accumulate and require periodic removal and disposal on the HLP.

20.1.6.3 Biological Monitoring and Maintenance

Maintaining a healthy, robust biological system will improve both the physical and geochemical performance of the closed heap. Thus, the periodic inspections will pay special attention to the biological environment, the health of the vegetated areas as well as the health of the down-stream habitats and surrounding vegetative areas. Reseeding will be planned annually for the first approximately 3 years, or as needed. Biological monitoring will continue as long as physical monitoring does, and at least until all habitat and vegetative areas have been stable for multiple years and through extreme wet and dry seasons.

20.1.6.4 Surplus Water Management

During draindown periods when the water cannot be effectively evaporated in an evaporation pond, solutions will be pumped on top of the heap as irrigation water for the revegetated areas and evaporated on top of the HLP. Alternatively, draindown solutions may be pumped to the developing pit lake if water quality is adequate and is not predicted to affect the pit lake water quality. Costs for this program will principally be pump maintenance and provision of electrical power.

If the geochemistry of the heap effluent supports closing the ponds, then they will be decommissioned and closed at such time. The liners will be perforated and the ponds backfilled with permeable waste rock or rinsed leached material.

If the long-term HLP seepage does not meet standards, the seepage will be managed by evaporation ponds, constructed by converting the HLP solution management ponds to evaporation ponds. Initial draindown modeling by HydroGeoLogica indicates, with a cover, the long-term seepage rate is expected to be low enough for effective management by evaporation over the long term.

20.1.7 Closure Cost Estimates – Heap Leach Facilities

Costs for concurrent reclamation and closure, including G&A, have been estimated at US\$0.54 per tonne of ore processed, or approximately US\$36.1 million over the life of the Project (including US\$7.6 million for G&A costs during closure). These costs are in addition to any reclamation and closure costs considered in the normal operating and sustaining cost estimates.

Costs for concurrent reclamation are considered to begin during Year 10 of production and continue throughout the life of the mine, including a three-year closure period.

Estimated closure costs by year are presented in Table 20-1 below, not including G&A:

**Table 20-1
Summary of Camino Rojo Closure Costs**

Description	Year 10	Year 11	Year 12	Year 13	Year 14	Total
Closure Plan (Regulatory Approval)	\$100,000					\$100,000
Topsoil/Revegetation of Preg/Excess Pond (Haulage/Placement)				\$67,838	\$22,613	\$90,450
Topsoil/Revegetation of Waste Dump	\$330,764	\$36,752				\$367,516
Topsoil/Revegetation of Heap Leach Pad				\$244,215	\$244,215	\$488,430
Regrade of Heap Leach Pad				\$631,800	\$631,800	\$1,263,600
Leach Pad Waste Cover				\$976,860	\$976,860	\$1,953,720
Water Control Infrastructure			\$50,000			\$50,000
Pregnant Pond Partial Fill				\$120,500		\$120,500
Excess Pond Partial Fill				\$298,238	\$99,413	\$397,650
Pond Drainage Revision					\$100,000	\$100,000
Demolish. Removal of Mine Infrastructure and Camp		\$0				\$0
Building Slabs (Bury In-Place or to Heap/Ponds)			\$25,000	\$25,000		\$50,000
Crushers / MC plant		\$512,348		\$283,052		\$795,400
Remediation of disturbed areas			\$98,280	\$49,140	\$16,380	\$163,800
Remediation of hydrocarbon affected areas				\$11,688		\$11,688
Hazardous Waste Removal				\$10,000		\$10,000
Remediation of Chemical Affected Areas				\$59,400	\$19,800	\$79,200
Reclaim Tunnel Closure		\$50,000				\$50,000
Access Road Closure to Restricted Areas					\$66,000	\$66,000
Removal of Haul Road					\$723,000	\$723,000
Monitoring of Mine for 10 years					\$100,000	\$100,000
Labor	\$176,069	\$352,138	\$1,760,689	\$704,276	\$528,207	\$3,521,378
Heap Rinsing & Neutralization		\$9,397,936	\$2,578,195	\$1,344,542	\$540,589	\$13,861,262
Support Services		\$97,896	\$195,793	\$97,896	\$97,896	\$489,482
Contingency (15%)	\$91,025	\$1,567,060	\$706,193	\$738,667	\$625,016	\$3,727,961
Total (not including G&A)	\$697,858	\$12,014,130	\$5,414,150	\$5,663,111	\$4,791,788	\$28,581,037

20.2 Permitting

Exploration and mining activities in Mexico are subject to control by SEMARNAT, which has authority over the two principal Federal permits:

- i. A Manifesto de Impacto Ambiental (MIA) or Environmental Impact Statement accompanied by an Estudio de Riesgo (ER); and
- ii. A Cambio de Uso de Suelo (CUS), supported by an Estudio Tecnico Justificativo (ETJ).

Thus far exploration work at Camino Rojo has been conducted under the auspices of two separate MIA permits and corresponding CUS permits. These permits allow for extensive exploration drilling but are not sufficient for mine construction or operation.

In April 2018, Orla hired independent environmental permitting consultants to design and implement baseline environmental studies of the Camino Rojo Project, and to work with Orla's consultant engineers to collect the data required for obtaining a Manifesto de Impacto Ambiental and Cambio de Uso de Suelo permit, and to prepare the documents needed to solicit and obtain the MIA and CUS permits necessary for mine construction and operation.

MIA and CUS permit applications were submitted to SEMARNAT on 29 and 30 August 2019, respectively, for the construction and operation of an open pit mine as per the Project described in 2019 Technical Report. Federal environmental authorities approved this CUS permit in December 2019, Minera Camino Rojo made the requisite payment to the National Forestry Commission (Comision Nacional Forestal) on 23 January 2020, and MCR received the CUS permit on 6 February 2020, via Oficio No. DFZ152-201/20/0196, allowing mine development and operation affecting 816.25 ha. The Project described in this Technical Report will require an additional CUS permit to allow for additional surface disturbances related to development of a pit layback onto lands not considered in the August 2019 permit application. The additional CUS permit is expected to require 3 months for preparation of the application, and an additional 6 months for review and issuance of resolution by SEMARNAT.

MCR received the MIA permit on 11 August 2020, via Oficio No. SGPA/DGIRA/DG/03478, authorizing mine construction and operation of the project described in the 2019 Technical Report. The Project described in this Technical Report, at the discretion of SEMARNAT may require a modification to the MIA permit, or obtention of an additional MIA permit, to allow for additional production related to development of a pit layback onto lands not considered in the August 2019 permit application. Process methods and process infrastructure do not change. The MIA permit modification or additional MIA permit is expected to require 3 months for preparation of the application, and an additional 6 months for review and issuance of resolution by SEMARNAT.

Federal regulations require staged postings of a bond or financial guarantee for the estimated cost of reclamation, proportional to the pending reclamation work created by the Project in each development phase, as determined by a Technical Economic Study. On 11 November 2020, MCR submitted the required first stage reclamation bond of \$89,451,775 Pesos (approximately \$4.5 M USD) which was accepted by the Federal Treasury, with formal notice given to the Procuraduria Federal de Proteccion al Ambiente (PROFEPA), on 13 November 2020. All MIA and CUS permit conditions have been satisfied, allowing for site activities to commence for the Project described in the 2019 Technical Report.

MCR received a Municipal Construction Licence on 4 December 2020 from the Mazapil Municipality, authorizing construction of the mine and processing infrastructure as per the project described in the 2019 Technical Report. The Project described in this Technical Report will require a modification to the Municipal Construction License to allow for additional earthworks related to development of a pit layback onto lands not considered in the August 2019 permit application.

MCR currently has all major permits required for construction and operation of the project described in the 2019 Technical Report. Certain permits, including authorization from SEDENA to use and store explosives, cannot be obtained before facilities are built, and routine surface water management permits from CONAGUA, required for construction surface drainage diversion works and road crossings, are in progress. Receipt of these permits is not expected to affect project timelines. There are no impediments to construction, mining, and processing activities for the already authorized project while permit modifications for the project described in this Technical Report are in the application process.

The Project is not located in an area with a special Federal environmental protection designation and no factors have been identified that would be expected to hinder authorization of required Federal, State and Municipal environmental permits.

The Peñasquito mine, a large scale, open pit mine, presently operated by Newmont, is in the same Municipality and the mine encountered no impediments to receipt of needed permits.

The Qualified Person responsible for this section of the Technical Report believes that the permitting risk for the project is similar to that of any mining project of similar scope in North America.

Table 20-2 summarizes the Federal, State, and Municipal permits required for mine construction, and Table 20-3 for mine operation and closure. Figure 20.2 summarizes the permitting flow chart.

**Table 20-2
Permits Required for Mine Construction**

Mining Stage	Required formality		Agency	Response time (Aprox.)	Comments
CONSTRUCTION	OPTION 1	Environmental Impact Manifest (MIA)	SEMARNAT	3-6 months	Baseline studies should be conducted to support the MIA. A comprehensive environmental manifest shall be prepared and submitted to SEMARNAT for evaluation and authorization.
		Land Use Change Study (ETJ)	SEMARNAT	2-3 months	A detailed forestry inventory and a technical study shall be prepared and submitted to SEMARNAT for evaluation and authorization.
		Risk Analysis Study (ER)	SEMARNAT	3-6 months	A risk analysis shall be prepared and submitted and will be evaluated together with the MIA, when high risk substances such as cyanide is used in the process.
	OPTION 2	Documento Técnico Unificado (DTU)	SEMARNAT	3-6 months	A comprehensive technical document that integrates information of the MIA, ER and ETJ should be prepared and submitted to SEMARNAT for evaluation and authorization.
	Land Use/construction Licence	Municipality	1 month	An application letter shall be submitted to the municipal authorities to obtain the authorization letter.	
	Permit for disposal of non-hazardous residues	Municipality	1 month	An application letter needs to be submitted to the municipal authorities, specifying the expected type and amount of non-hazardous waste from the mine construction and operation.	
	Explosive handling	SEDENA, Municipality and State Government of Zacatecas	3 months	An application letter shall be submitted to SEDENA. Also an endorsement letter shall be obtained from the State Government and the Municipality.	
	Archeological clearance	INAH	1 to 8 months	A request letter should be submitted to INAH. A survey will be done by INAH personnel and if there is some archeological interest a rescue and documenting program will be performed.	
	Water use concessions	CONAGUA	3 months	An application should be submitted to CONAGUA requesting a water use concession, specifying the volume of water to use per year. If the aquifer has no availability, water rights need to be purchased. The volume of water to be used in the mining activities should be measured and paid.	

**Table 20-3
Permits Required for Mine Operation and Closure**

Mining Stage	Required formality	Agency	Response time (Aprox.)	Comments
OPERATION	Water discharge permit	CONAGUA	3 months	An application needs to be filed before CONAGUA with estimated annual volume and the quality of the discharge. This may include the sanitary service water discharge or any other water discharge to septic tanks or natural environment.
	Operation licence	SEMARNAT	2 to 4 months	Needs to do an inventory of all air emissions, water discharges and solid wastes.
	Accident prevention plan	SEMARNAT	None	Based on the risk analysis, it is necessary to establish a plan and procedures to prevent and respond to emergencies and accidental events. SEMARNAT will register this plan.
	Mining residues management plan	SEMARNAT	None	Need to prepare this plan according to NOM-157-SEMARNAT-2009. SEMARNAT will register this plan
	Hazardous waste generator registry	SEMARNAT	None	It is required to keep records of any hazardous waste movement at the mine facilities and deliveries to an authorized external company.
ABANDONMENT	Closure and reclamation plan	SEMARNAT	Not specified	Need to submit a comprehensive closure and reclamation plan, as early as possible before the closure of the mine.

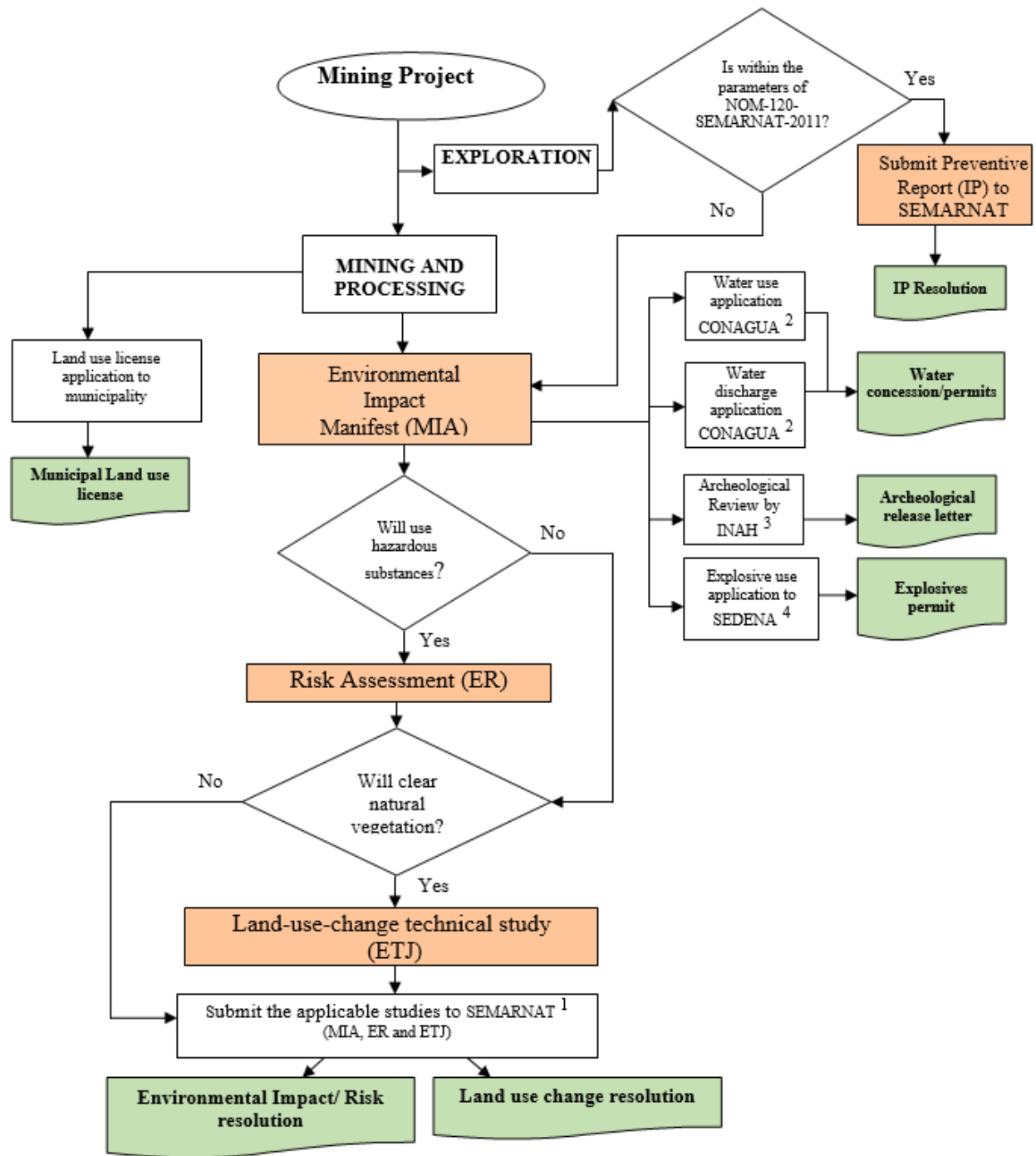

Figure 20.2 Permitting Process Flowsheet

20.3 Social and Community Impact

20.3.1 Background

The Project has a long association with the local communities, including Community and Social Responsibility Agreements as described in Section 4.3 of this Technical Report. Minera Camino Rojo has a fulltime community and social relations department working on site in San Tiburcio, and has enjoyed a pacific and mutually beneficial relationship with the local communities.

In April 2018, Orla commissioned ERM, a global provider of environmental, health, safety, risk, social consulting services and sustainability related services, to conduct an independent assessment of social and community impacts of development of the Camino Rojo Project, and to provide guidance on actions and policies needed to ensure that Orla obtains and maintains social licence to operate. The study was completed in May 2019 (ERM, 2019) and salient results are being incorporated into the project development and permitting plans. Key points are summarized as follows:

Principal concerns of affected stakeholders in surrounding communities are:

- i. Employment of community members
- ii. Community benefits from improved public services and investment in community development
- iii. Environmental contamination
- iv. Increased community population and strain on public services
- v. Water shortages

Principal concerns of Ejido members whose land is affected are:

- i. Just economic compensation
- ii. Assistance in obtaining title to informally owned parcels

Principal concerns of local and State government authorities are:

- i. Generation of employment
- ii. Improvement of local infrastructure
- iii. Service contracts to local businesses
- iv. Environmental contamination

ERM identified the principal social and community impacts of the Project and concluded that the Project does not put at risk the social environment of the nearby communities because the impacts can be mitigated or made positive with the implementation of a Social Management System (SMS). ERM has designed a SMS based on International Association of Impact Assessment best practices.

Population, demographic, and local infrastructure information presented in Sections 20.3.1 through 20.3.4 are derived from Instituto Nacional de Estadística, Geografía e Informática (INEGI - National Institute of Statistics and Geography) and a social and community impact report prepared by ERM de Mexico SA de CV (ERM, 2019).

20.3.2 Population and Demographics

20.3.2.1 Indigenous Communities

According to census data from the Comisión Nacional para el Desarrollo de los Pueblos Indígenas (CDI – National Commission for the Development of Indigenous Communities) the localities are not categorized as indigenous localities. ERM's field visit corroborated that there is no indigenous presence in the CAI.

20.3.2.2 Inhabitants, Age and Gender

ERM defined the Core Area of Influence (CAI) of the Project and a broader Area of Direct Influence (ADI) of the Project according to IAIA and International Finance Commission criteria. The communities nearest to the Project, San Tiburcio, San Francisco de los Quijano, and El Berrendo have a combined population estimated at 1,209 persons. An additional 2,072 persons live in the communities that comprise the broader area of direct influence. Population by community is summarized in Table 20-4.

Table 20-4
Populations of Communities in Area of Influence of Project

Area of Influence Category	Locality	Population, INEGI Data, 2010 Census	Population, 2018 Camino Rojo Census
Core Area of Influence (CAI)	El Berrendo	149	152
Core Area of Influence (CAI)	San Francisco de los Quijano	45	52
Core Area of Influence (CAI)	San Tiburcio	548	1005

Total **742** **1209**

Area of Direct Influence (ADI)	Banderita Dos	118	N/A
Area of Direct Influence (ADI)	El Calabazal	36	N/A
Area of Direct Influence (ADI)	Tanque de los Hacheros (Hacheros)	90	N/A
Area of Direct Influence (ADI)	Majoma	334	N/A
Area of Direct Influence (ADI)	La Pardita	207	N/A
Area of Direct Influence (ADI)	Pozo de San Juan	225	N/A
Area of Direct Influence (ADI)	Presa del Junco	245	N/A
Area of Direct Influence (ADI)	Cardona (Rancho Nuevo)	294	N/A
Area of Direct Influence (ADI)	Salto de San Juan	130	N/A
Area of Direct Influence (ADI)	San Benito (El Salitrillo)	21	N/A
Area of Direct Influence (ADI)	San Elías da la Cardona	214	N/A
Area of Direct Influence (ADI)	Tanquecillos	158	N/A

Total **2072**

According to the 2010 INEGI census, in all three localities of the CAI area, the male population presented a slight majority, however the 2018 census by Minera Camino Rojo showed that the communities of El Berrendo and San Tiburcio had slight female majorities.

The 12 localities that comprise the ADI all have a greater proportion of men than of women in a range of 50% to 57.4%, with the exception of El Calabazal, where 63.9% of its inhabitants are men and 36.1% are women. As a consequence, the proportion of women is below the state average of 51.2%.

In El Berrendo and San Tiburcio, the largest age group comprising approximately 60% is the population 15 to 64 years of age, which INEGI defines as the working age population, followed by the population between 0 to 14 years of age (~30%) and the age group 65 years old or older that represents approximately 10% of the population. The only town that presents a different distribution is San Francisco de los Quijano, where the second largest age group is the population over 65 years of age equivalent to 31.1% of the population and 8.9% of the population ranging from 0 to 14 years.

The majority age group is the population between 15 and 64 years old, followed by the group between 0 and 14 years and finally, the over 64 years old population. In all communities of the ADI the trend repeats itself.

20.3.2.3 Education

San Tiburcio has a kindergarten, primary school, secondary school, and preparatory (high) school.

The illiteracy rate in the three localities of the CAI is greater than the percentage at the state level (4%) however there are significant differences. In El Berrendo and San Tiburcio between 7% and 6% of the population aged 15 and over is illiterate. In San Francisco de los Quijano, almost a quarter of the population is illiterate (22%).

The percentage of the population greater than 15 years old that has completed a primary school education varies significantly depending on the locality. In San Francisco de los Quijano the percentage of the population that has completed primary education is 44%, in San Tiburcio it is 14%, and in El Berrendo it is 11%.

In El Berrendo, 21% of the population aged 15 or older has completed high school, a percentage higher than the State average of 16%. In comparison with the locality of El Berrendo, both the localities of San Francisco de los Quijano as San Tiburcio, show lower percentages of completion of secondary education, 11% and 16% respectively.

At the state level, the average level of education completed is 7.9 years. In general, the Zacatecas population finished primary school, but not secondary school. In the case of localities of the CAI,

the best average educated level is in San Tiburcio which has an average of 7.05 years of schooling, followed by El Berrendo with 6.33 and San Francisco de los Quijano with 3.51.

Similar to the educational data for the CAI, the population of the ADI likewise has relatively low educational level compared to State averages.

20.3.3 Infrastructure and Public Services

The locality in the CAI that has the best provision of public services, surpassing even the state average, is San Tiburcio. There, 91% of homes have electricity, in contrast to the state average which is 73%. In addition, 89% of homes have access to piped water, 87.5% have a toilet and 74% have drainage in their homes. In the case of El Berrendo and San Francisco de los Quijano, access to public services is lower. Both locations have similar percentages of houses with sanitary drainage (60% and 59% respectively), homes with a toilet (67% and 77% respectively), and homes with access to the electricity network (72% and 77% respectively). The biggest difference is the percentage of homes with access to piped water. In El Berrendo 72% of the houses have piped water, while in San Francisco de los Quijano only 5% of homes have access to water.

El Berrendo has a water purification plant that represents the only significant economic and commercial activity for the community beyond very small-scale agriculture. The water treatment plant attracts people from other nearby localities that obtain their drinking water from this government subsidized plant.

The town with greatest access to public services is Salto de San Juan, there at least 80% of the houses have piped water, drainage, toilet and electricity. On the other extreme is El Calabazal, where 100% of its homes lack drinking water and drainage. In addition, in 5 of the 12 localities that make up the ADI no houses with access to drinking water were identified. Except for Salto de San Juan, the percentage of homes with drainage is below the state average.

Access to media and communications is dominated by television in the three localities of the CAI. In both El Berrendo and in San Tiburcio, over 90% of homes have television (93.6% and 93.6% respectively) while San Francisco de los Quijano, 76.5% of the housing has television. Radio is available in 58.1% of homes in El Berrendo, 70.6% in San Francisco Los Quijano and 48.8% in San Tiburcio. All three locations are below the state average of 82.2%. San Tiburcio is the locality where more houses have a computer (23.2%), even above the state average of 22.5%. In El Berrendo and San Francisco de los Quijano, the percentage of homes with a computer is minimal. All three communities have minimal access (San Tiburcio) or no internet access (El Berrendo and San Francisco de los Quijano).

All communities in the ADI have access to television and radio. However, only in San Benito (El Salitrillo) the percentage of dwellings that have television is higher than the state average. In the case of radio, El Calabazal has the highest number of houses with radios. None of the 12 locations have access to the internet while access to computers and cell phones is limited. In 8 of 12 localities the percentage of homes with computers does not exceed 10% and half of the locations do not have cell phones. As in the CAI, television is the main means of communication to which the inhabitants they have access. The internet and the computer are the mediums with the least coverage.

Health services are insufficient in the CAI. At the state level, 68% of the population has rights to public health services, 35% is affiliated with Popular Insurance, 25% is entitled to the Mexican Insurance Institute Social Security (IMSS) and 7% to the Institute of Security and Social Services of State Workers (ISSSTE). The community within the CAI with the highest percentage of population with access rights to medical service is San Francisco de los Quijano with 98%, followed by El Berrendo with 74% and San Tiburcio with 49%. Both in San Francisco de los Quijano and in San Tiburcio, the population with access to medical services is affiliated with IMSS, while, in El Berrendo, 48% is affiliated with the Seguro Popular.

ERM's field surveys indicate that the health services in the three communities of the CAI are insufficient. Both the inhabitants of El Berrendo and those of San Francisco de los Quijano, (including those from the La Fábrica neighbourhood) attend the San Tiburcio health centre (Figure 20.3). The current clinic does not cover the needs of the population. There are State and Municipal plans to construct a new medical clinic in San Tiburcio. Local residents communicated that when services are not available in San Tiburcio, patients must travel to Concepción del Oro.



Figure 20.3 Medical Clinic in San Tiburcio – ERM 2018.

In the ADI, in 8 of the 12 communities the percentage of the population with rights to medical care exceeds the state average (68%). The best served communities are Presa del Junco and Salto de San Juan where 94% of the population has access to public health services. In contrast, the localities with the lowest percentage of population with access to medical services are: San Benito (El Salitrillo), where less than half of its population has access (43%), Majoma, with 26% and La Pardita where 94% of its population is not a beneficiary of either of IMSS, ISSSTE, nor Popular Insurance coverage. The medical service that has the highest percentage of affiliates in the ADI is IMSS, followed by ISSSTE and Popular Insurance.

20.3.4 Government and Community

All communities in the CAI are part of the Municipality of Mazapil, governed by an elected Mayor (Presidente Municipal). As discussed in Section 4.3 of this Technical Report, three Ejidos, self-governing agricultural cooperatives, are part of the CAI and while subject to governance of the Municipality, the Ejidos have rights over the use of Ejidal lands.

ERM conducted field surveys of the three localities that comprise the CAI. In all three localities, the predominance of houses were built with concrete block and vault ceilings (Figure 20.4), however, some houses built with sheet or cardboard were also observed. Most houses have a water tank, since the water service is insufficient. Particularly in the town of San Francisco de los Quijano, many dwellings were observed uninhabited and abandoned (Figure 20.5). Many dwellings in the CAI have chicken coops, solar panels, orchards, and other self-sustainable features. The Ministry of Agriculture, Livestock, Rural Development, Fisheries and Food (SAGARPA) implemented both in El Berrendo and in San Francisco de los Quijano and San Tiburcio, a program called "Strategic Project of Food Security" (PESA) with the objective of supporting family food production in rural localities of high and very high marginalization. Based on the information collected through focus groups, it was found that particularly in El Berrendo there is a very positive perception about the PESA program.



Figure 20.4 Home in El Berrendo – ERM 2018



Figure 20.5 Unoccupied Home in San Francisco de los Quijano – ERM 2018.

Public space infrastructure is scarce. San Tiburcio is the community with the most significant public spaces, including a town square with a kiosk, public lighting, benches and fencing (Figure 20.5). The neighbourhood of La Fábrica, although it is part of the ejido de San Tiburcio, has less infrastructure in its public spaces (Figure 20.6). All three communities of the CAI have ejidal

community buildings, which are commonly used for meetings of the Ejidal Comisariado. The ejido community room of El Berrendo was funded by Goldcorp and is in good condition.



Figure 20.6 Town Plaza in San Tiburcio – ERM 2018.



Figure 20.7 Public Plaza in La Fabrica (part of San Tiburcio) – ERM 2018.

20.3.5 Economic Activity, Income, Marginalization

The main economic activities in the area are agriculture and livestock, although a large part of the production of these sectors is used for self-consumption. The mining industry in the area, a tortillería, the Mahoma solar energy park 40km south of the Project area, and small businesses and restaurants in San Tiburcio and along Federal Highway 54 are the main sources of

employment in the CAI. Minera Camino Rojo and its subcontractors are a significant local employer, with approximately 40 local community members employed.

The Consejo Nacional de Población (CONAPO - National Population Council) has developed metrics to quantify the marginalization of communities in Mexico. The degree of marginalization is a summary measurement allowing differentiation of communities according to the impact of the deficiencies that the population suffers as a result of the lack of access to education, lack of adequate housing, and lack of goods and services. Marginalization is also expressed in the unequal distribution of progress and exclusion of various social groups. CONAPO has determined that two of the three communities in the CAI, El Berrendo and San Francisco de los Quijano, have a high degree of marginalization, while San Tiburcio has a moderate degree of marginalization (Table 20-5).

**Table 20-5
Marginalization by Community**

Community	Marginalization Index (CONAPO, 2010)	Degree of Marginalization
El Berrendo	-0.789659188	High
San Francisco de los Quijano	-0.148593057	High
San Tiburcio	-1.047676631	Medium

The Consejo Nacional de Evaluación de la Política de Desarrollo Social (CONEVAL – National Council for Evaluation of Social Development Policy) for 2010, in the municipality of Mazapil, of which the CAI communities are part of and which has a total population of 18,603, determined that 67.8% of the inhabitants of the municipality lived in poverty (12,247 inhabitants). 5.5% of the population (999 people) was considered economically vulnerable due to low income, while 73.4% (13,246 inhabitants) had income below the level required for basic well-being, of which 6,357 inhabitants (35.2% of total population) had income below the level required for minimum well-being.

The Economically Active Population (EAP) in a community is defined as the total population 15 years and older who have a job or who, not having work, are looking for work. At the state level, 35.5% is in the EAP. In San Francisco de los Quijano 42.2% is within that category, followed by the towns of San Tiburcio and El Berrendo with 33.4% and 32.2% respectively. The inactive population refers to pensioners or retired people, students, people dedicated to the home, or people who have some permanent physical or mental limitation that prevents them from working. In the CAI, all communities have percentages of inactive population above the state percentage of 38.6%. The town that has the highest percentage of non-economically active population is San Francisco de los Quijano with 48.9%, followed by the town of El Berrendo with 47.7% and finally,

San Tiburcio with a 40.5%. The employed population corresponds to those over 15 years of age who practise some activity in the production of goods and services, which is remunerated. Of the localities of the CAI only one, San Francisco de los Quijano, is above the Zacatecas state average (33.7%) with 42.4%. Both El Berrendo (32.3%) and San Tiburcio (32.5%) are slightly below the state average. The willfully inactive population refers to people over 15 years of age who by choice do not participate in paid productive activities, for example, students, housewives, pensioners, retirees, etc. This category is exceeded by all others in all three communities in the CAI.

20.3.6 Social Management System and Mitigation of Negative Impacts

The social and community impact study completed by ERM identified 19 significant concerns and impacts of the Project to the local communities and stakeholders. Each impact or concern is categorized as potentially positive (P), potentially negative (N), or neutral and are as follows:

- i. Economic development (P)
- ii. Creation of technical capabilities in communities (P)
- iii. Economic displacement due to land use and road diversion (N)
- iv. Increase in the payment of taxes at Municipal, State and Federal level by the Project (P)
- v. Restoration of site after closure (neutral)
- vi. Social investment in the communities (P)
- vii. Induced migration (N)
- viii. Property damage (N)
- ix. Increase in the cost of living (N)
- x. Construction of new infrastructure that benefits community (P)
- xi. Pressure on public services from Project employees (N)
- xii. Re-routing of roads (neutral)
- xiii. Damage to roads (N)
- xiv. Traffic issues due to increased Project related traffic (N)
- xv. Landscape changes (N)
- xvi. Noise and dust generation (N)
- xvii. Environmental contamination and degradation of natural resources (N)
- xviii. Accidents and emergencies (N)
- xix. Occupational injuries and diseases (N)

The impacts incurred during the exploration and development stage are generally positive, and the potentially negative impacts will be mitigated. The concern of economic displacement due to land use and road diversion will be mitigated through implementation of a development plan that ensures the correct compensation (economic or in-kind services, or a mixture) of the persons correctly identified as affected, such a plan includes investments in projects that improve the

quality of life of the people of the ADI. Such a strategy is already in place as part of Orla's Collaboration and Social Responsibility Agreements with the local Ejidal communities.

Significant impacts during the construction phase can be reduced through mitigation measures, including community consultations and agreements on the criteria used to decide on the deviation of traditional roads, and development of strategic alliances with Government entities to mitigate the impact of demand on public infrastructure and services by project workers. Environmental and social monitoring systems will be implemented to monitor noise and dust levels to ensure that they do not exceed the levels established by the Mexican regulations.

The environmental impacts during the operation and production stage will be mitigated through implementation of the operation and closure plans described in this Technical Report, particularly those designed to minimize the long-term impact to the local environment. During the closure and remediation stage the Project will enact the mitigation measures included in the environmental studies and permitting reports prepared for the Project, and such measures will meet Mexican regulations and meet or exceed industry best practices. The company will communicate these measures in an efficient and transparent manner.

ERM concluded that the Project does not put at risk the social environment of the neighbouring communities, given that social impacts and risks can be prevented, mitigated or if positive, expanded, through the implementation of a Social Management System (SGS). The SGS for the Project was designed based on the best practices and guidelines of the International Association for Social Impact Assessment (IAIA) and is supported by Orla's Corporate Social Responsibility Policy and Environment & Sustainability, Health & Safety Policy. Orla plans to develop the Camino Rojo Project in accordance with International Finance Corporation Performance Standards, as well as the International Council on Mining and Metals principles.

21.0 CAPITAL AND OPERATING COSTS

Capital and operating costs for the process and general and administration components of the Camino Rojo Project were estimated by KCA with cost information based on firm vendor quotes and committed costs for construction provided by Orla. Costs for the mining components were provided by IMC. The estimated costs are considered to have an accuracy of +/-15% and are discussed in greater detail in this Section.

The total Life of Mine (LOM) capital cost for the Project is US\$167.5 million, including US\$9.8 million in working capital and not including reclamation and closure costs which are estimated at US\$28.6 million, IVA (value added tax) or other taxes; all IVA is applied to all capital costs at 16% and is assumed to be fully refundable. Table 21-1 presents the capital requirements for the Camino Rojo Project.

**Table 21-1
Capital Cost Summary**

Description	Cost (US\$)
Pre-Production Capital	\$ 134,056,000
Working Capital & Initial Fills	\$ 9,845,000
Sustaining Capital – Mine & Process	\$ 23,565,000
Total excluding IVA	\$ 167,467,000

The average life of mine operating cost for the Project is US\$8.17 per tonne of ore processed. Table 21-2 presents the LOM operating cost requirements for the Camino Rojo Project.

**Table 21-2
LOM Operating Cost Summary**

Description	LOM Cost (US\$/t)
Mine	\$3.37
Process & Support Services	\$3.20
Site G & A	\$1.60
Total	\$8.17

IVA is not included in the operating costs.

21.1 Capital Expenditures

The required capital cost estimates have been based on the design outlined in this Technical Report. The scope of these costs includes all expenditures for process facilities, infrastructure, construction indirect costs, mine contractor mobilization and owner mining capital costs for the Project. Construction activities including purchasing of equipment, award of major construction contracts, and mobilization of contractors at site are currently in progress for the Project as of the date of this Technical Report and all efforts have been made to report all current costs and estimations as accurately as possible.

The capital costs presented in this Technical Report have been updated from the capital costs contained in the 2019 Technical Report as a result of current engineering and construction activities. The costs are based on a combination of the 2019 Technical Report results and on new costs from the ongoing EPCM work. Updated cost information from firm supplier quotes, purchase orders issued or committed costs for construction have been provided by Orla and utilized for the cost estimates based on ongoing EPCM and construction activities. For all major equipment packages, construction contracts and infrastructure items not covered by purchase orders or updated quotes, multiple quotes were obtained for the 2019 Technical Report but not updated for this Technical Report. All equipment and material requirements are based on design information described in previous sections of this Technical Report.

As of the date of this Technical Report, Orla has completed over 90% of the detailed engineering for the project outlined in the 2019 Technical Report and procurement is 85% complete. A total of US\$78 million of the total Project capital has been committed through purchase orders and contracts.

All capital cost estimates are based on the purchase of equipment quoted new from the manufacturer or estimated to be fabricated new.

The total pre-production capital cost estimate for the Camino Rojo Project is estimated at US\$143.9 million, including all process equipment and infrastructure, construction indirect costs, mine contractor mobilization and working capital. Where prices were quoted in Mexican Pesos, an exchange rate of 19.3 MXN:1 US\$ was used.

Pre-production capital costs required for the Camino Rojo Project by area are presented in Table 21-3.

Table 21-3
Summary of Pre-Production Capital Costs by Area

Plant Totals Direct Costs	Total Supply Cost US\$	Install US\$	Grand Total US\$
Area 110 - General	\$15,498,000	\$3,820,000	\$19,318,000
Area 113 - Crushing	\$14,027,000	\$7,573,000	\$21,600,000
Area 115 - Heap Leach Stacking	\$9,442,000	\$828,000	\$10,271,000
Area 120 - Heap Leach Pad & Ponds	\$5,224,000	\$8,187,000	\$13,411,000
Area 128 - Merrill-Crowe	\$8,980,000	\$2,953,000	\$11,933,000
Area 131 - Refining (incl. Area 128)	\$0	\$0	\$0
Area 134 - Reagents	\$56,000	\$5,000	\$61,000
Area 360 - Power	\$4,781,000	\$473,000	\$5,254,000
Area 362 - Water Supply & Distribution	\$2,802,000	\$1,625,000	\$4,428,000
Area 365 - Laboratory	\$1,740,000	\$6,000	\$1,746,000
Area 367 - Mobile Equipment	\$2,080,000	\$0	\$2,080,000
Total Direct Costs	\$64,631,000	\$25,472,000	\$90,103,000
Spare Parts	\$1,449,000		\$1,449,000
Sub Total with Spare Parts			\$91,552,000
Contingency	\$11,795,000		\$11,795,000
Total Direct Costs with Contingency			\$103,347,000
Mining Costs			\$2,577,000
Indirect Costs			\$2,617,000
Other Owner's Costs			\$17,495,000
Initial Fills			\$806,000
EPCM			\$8,020,000
Sub Total Costs before Working Capital			\$134,862,000
Working Capital (60 days)			\$9,039,000
TOTAL COSTS (excluding IVA)			\$143,902,000

21.1.1 Mining Capital Costs

Mining capital costs for the Camino Rojo Project have been estimated by IMC and include costs for contractor mobilization and demobilization, owner equipment and mine development. The estimated mining cost is based on 18,000 tpd of ore production.

Life of mine mining capital costs are estimated at US\$3.64 million, and are presented in Table 21-4.

Table 21-4
LOM Mining Capital Costs

MINE CAPITAL COSTS	Units	PP	Yr1 Q1	Yr1 Q2	Yr1 Q3	Yr1 Q4	Year 2	Year 3	Year 4	Year 5	Year 6	Year 7	Year 8	Year 9	Year 10	Year 11	TOTAL
Contractor Mobilization & Demobilization	(\$x1000)	400							48							716	1,164
Owner Equipment	(\$x1000)	490	0	0	0	0	0	0	0	296	0	0	0	0	0	0	786
Mine Development	(\$x1000)	1,686	0	0	0	0	0	0	0	0	0	0	0	0	0	0	1,686
TOTAL MINE CAPITAL COST	(\$x1000)	2,577	0	0	0	0	0	0	48	296	0	0	0	0	0	716	3,636

21.1.1.1 Mining Contractor Mobilization and Demobilization

Mining contractor mobilization costs are based on a firm contractor quote and include US\$400,000 during pre-production and US\$48,000 during Year 4 of production. Contractor Demobilization is quoted at US\$716,000 which is the mobilization charges escalated 5% per year up to the demobilization time.

21.1.1.2 Mining Owner Equipment

Owner mining equipment for mine supervision, engineering and geology is considered and has been estimated at US\$786,000 for the life of the mine by IMC including US\$490,100 during preproduction and US\$295,700 sustaining capital during Year 5. Owner mining equipment costs include GPS and surveying equipment, mining software and licenses, computers, printers and a plotter and have been estimated based on quotes received by Orla and IMC including a 10% contingency. The costs assume pickup trucks for mine staff will initially be leased with replacement trucks being purchased during Year 5, along with new computers. Owner mining equipment costs are summarized in Table 21-5.

**Table 21-5
Owner Mining Equipment Capital Costs**

		Units	Total
EQUIPMENT PURCHASE SCHEDULE:			
Pickup Trucks		(none)	4
Surveying Equipment		(none)	1
Computer Workstations		(none)	18
Printer/Scanner/Copier		(none)	4
Large Format Plotters		(none)	2
Software Licence Fees		(none)	1
Total Major Equipment Purchases		(none)	30
EQUIPMENT CAPITAL COST:			
	Unit Price (\$x1000)		
Pickup Trucks	52.5	(\$x1000)	210.0
Surveying Equipment	30.8	(\$x1000)	67.0
Computer Workstations	4.0	(\$x1000)	72.0
Printer/Scanner/Copier	7.9	(\$x1000)	31.6
Large Format Plotters	10.0	(\$x1000)	14.0
Software Licence Fees	87.5	(\$x1000)	319.7
OWNER EQUIPMENT CAPITAL COST		(\$x1000)	714.3
CONTINGENCY/MISC @	10.00%	(\$x1000)	71.4
TOTAL EQUIPMENT COST		(\$x1000)	785.7

21.1.1.3 *Mine Development (Preproduction)*

Mine development or preproduction at US\$1.69 million is the estimated operating cost to mine 1.02 million tonnes of material during the three-month preproduction period based on the contractor mining quote. The mine development cost is presented in Table 21-6.

**Table 21-6
Mine Development Capital Costs**

Description	Units	Total
Mining Contractor	(\$x1000)	1,299
Blasting Contract	(\$x1000)	261
Technical Services Personnel	(\$x1000)	81
Technical Services Supplies	(\$x1000)	45
TOTAL COST - Development	(\$x1000)	1,686

21.1.2 Process and Infrastructure Capital Cost Estimate

21.1.2.1 Process and Infrastructure Capital Cost Basis

Process and infrastructure costs have been estimated by KCA with updated cost information provided by Orla for current construction activities. All equipment and material requirements are based on the design information described in previous sections of this Technical Report. Budgetary capital costs have been estimated primarily based on Project specific quotes for all major and most minor equipment as well as contractor quotes for all major construction contracts. Multiple quotes were received for all major packages (three or more in most cases). Where available, firm and committed costs have been used.

Supplier and contractor quotes used in the cost estimates were selected based on a combination of factors including price, completeness of proposal and capabilities of the vendor. Where Project specific quotes were not available a reasonable estimate or allowance was made based on recent quotes in KCA's files. All capital cost estimates are based on the purchase of equipment quoted new from the manufacturer or to be fabricated new.

Each area in the process cost build-up has been separated into the following disciplines, as applicable:

- Major earthworks & liner;
- Civil (concrete);
- Structural steel;
- Platework;
- Mechanical equipment;
- Piping;
- Electrical;
- Instrumentation;
- Infrastructure & Buildings;
- Supplier Engineering; and
- Commissioning & Supervision.

Pre-production process and infrastructure costs by discipline are presented in Table 21-7.

Table 21-7
Summary of Process & Infrastructure Pre-Production Capital Costs by Discipline

Discipline Totals	Cost @ Source	Freight	Customs Fees & Duties	Total Supply Cost	Install	Grand Total
	US\$	US\$	US\$	US\$	US\$	US\$
Major Earthworks				\$3,024,000	\$16,865,000	\$19,888,000
Civils (Supply & Install)	\$4,599,000			\$4,599,000	\$0	\$4,599,000
Structural Steelwork (Supply & Install)	\$0			\$0	\$0	\$0
Platework (Supply & Install)	\$120,000			\$120,000	\$47,000	\$167,000
Mechanical Equipment	\$33,767,000	\$311,000	\$138,000	\$34,216,000	\$4,789,000	\$39,005,000
Piping	\$2,625,000	\$215,000	\$77,000	\$3,050,000	\$3,042,000	\$6,092,000
Electrical	\$4,311,000	\$462,000	\$133,000	\$4,934,000	\$602,000	\$5,536,000
Instrumentation	\$118,000	\$12,000	\$4,000	\$134,000	\$46,000	\$180,000
Infrastructure & Buildings	\$7,910,000	\$101,000	\$36,000	\$14,555,000	\$22,000	\$14,577,000
Supplier Engineering					\$0	\$0
Commissioning & Supervision					\$57,000	\$57,000
Spare Parts				\$1,449,000		\$1,449,000
Contingency				\$11,795,000		\$11,795,000
Total Direct Costs	\$53,449,000	\$1,101,000	\$390,000	\$77,875,000	\$25,472,000	\$103,347,000

Freight, customs fees and duties, and installation costs are also considered for each discipline. Freight costs are based on loads as bulk freight and have been estimated at 10% of the equipment cost. Where applicable, supplier quoted freight cost estimates for equipment were used in place of estimated freight.

Installation costs are based on the contractor quotes based on a detailed equipment list and estimated equipment weights or included in turn-key supplier packages. Quoted contractor costs include all labour, tools and support equipment required for proper placement and installation of equipment.

Where not directly quoted, installation is based an hourly installation rate of US\$40.08 which is derived from a contractor quote and estimated installation hours based on supply costs. The hourly installation rate includes added costs based on additional contractor expenses arising from the ongoing COVID-19 pandemic.

Engineering, procurement, and construction management (EPCM), indirect costs, and initial fills inventory are also considered as part of the capital cost estimate.

21.1.2.2 *Major Earthworks and Liner*

Earthworks and liner quantities for the Project have been estimated by KCA for all Project areas. Earthworks and liner supply and installation will be performed by contractors with imported fill being supplied by the mining contractor. Unit rates for site earthworks and liner supply and installation are based on firm contractor quotes. The earthworks and liner discipline also includes cost for materials to construct the crushing retaining wall.

Total preproduction earthworks and liner costs are estimated at US\$19.9 million.

21.1.2.3 *Civils*

Civils include detailed earthworks and concrete. Concrete quantities have been estimated by KCA based on layouts, similar equipment installations, vibrating equipment, major equipment weights and on slab areas. Unit costs for concrete supply, which include production (supply of aggregates, water and cement, batching and mixing), and delivery of concrete and concrete installation which includes all excavations, formwork, rebar, placement and curing are based on firm contractor quotes. Total costs for concrete are estimated at US\$4.6 million.

21.1.2.4 *Structural Steel*

Costs for all structural steel, including steel grating, structural steel, and handrails have been quoted by suppliers as part of equipment supply packages or included in supplier turnkey proposals.

21.1.2.5 *Platework*

The platework discipline includes costs for the supply and installation of steel tanks, bins, and chutes. Platework costs have been primarily quoted as part of complete equipment supply packages.

Total platework costs not included in the mechanical equipment supply costs are estimated at US\$167,500.

21.1.2.6 *Mechanical Equipment*

Costs for mechanical equipment are based on a detailed equipment list developed of all major equipment for the process. Costs for all major and most minor equipment items are based on purchase orders for construction, as well as firm and budgetary quotes from suppliers. Where Project specific supplier quotes were not available, reasonable allowances were made based on

recent quotes from KCA's files. All costs assume equipment purchased new from the manufacturer or to be fabricated new.

The mechanical equipment costs consider a complete turn-key bid for the Merrill-Crowe, Refinery and Cyanide dissolution system, complete engineering design and supply package for the crushing and reclaim systems and various equipment supply packages by several different suppliers. Installation costs for mechanical equipment are based on contractor quotes which include an added provision for COVID-19 related costs or are included as part of turn-key vendor packages.

The total installed mechanical equipment cost is estimated at US\$39.0 million.

21.1.2.7 *Piping*

Major piping, including heap irrigation and gravity solution collection pipes and water distribution pipes (raw water and fire water) are based on material take-offs and supplier quotes. Piping for the Merrill-Crowe and cyanide dissolution systems are included in the turn-key vendor supply package and are included in the mechanical equipment costs. Additional ancillary piping, fittings, and valve costs have been estimated on a percentage basis of the mechanical equipment supply costs by area ranging from 0% to 5%.

Installation costs for major piping is based on contractor quotes. Installation of ancillary piping has been estimated based on unit installation rates from the installation contractor and estimated installation hours based on the material supply costs. The total installed piping cost is estimated at US\$6.1 million.

21.1.2.8 *Electrical*

Major electrical equipment including transformers, substations, site powerlines, motor control centres and VFDs have been considered in the electrical equipment list and have been costed based on supplier / contractor quotes or have been included as part of turn-key or complete vendor supply packages. Also considered in electrical is the cost to relocate the electrical powerline which services the town of El Berrendo and construct a new 34.5 kV powerline with up to 10 MW capacity to serve the Project site.

Miscellaneous electrical costs have been estimated as percentages of the mechanical equipment supply cost for each process area and range between 0 and 25%.

Installation of electrical equipment and ancillary electrical items not included in turn-key vendor packages have been estimated based on unit installation rates from the installation contractor

quote and estimated installation hours based on the material supply costs. Supply and installation of the distribution powerline is based on a contractor quote.

The total installed electrical cost is estimated at US\$5.5 million.

21.1.2.9 *Instrumentation*

Instrumentation costs are primarily included as part of turn-key or complete vendor supply packages. Minor miscellaneous instrumentation costs have been estimated as percentages of the mechanical equipment supply cost for each process area and range between 0 and 5%.

The total installed instrumentation cost is estimated at US\$180,000.

21.1.2.10 *Infrastructure & Buildings*

Infrastructure and buildings for the Camino Rojo Project include the construction of an operations man camp, an administration building, mine truck shop, mine contractor offices, warehouse, guard house, on-site clinic, powder magazine, and light vehicle workshop. Process buildings including the laboratory, process workshop, reagents storage building, Merrill-Crowe plant and refinery are also included. Costs for the operations camp and site buildings are based on firm contractor quotes.

Water supply to the main water tank will be by production wells. One production well is in place. An additional production wells will be developed to provide redundancy. The production wells consider 200mm cased wells in 350mm boreholes and have an estimated cost of US\$350,000 each, including the cost of the well pump, discharge pipe and cabling. An allowance of US\$375,000 is also included for three monitoring wells based on costs of wells drilled on the property.

An allowance of US\$500,000 for modifications to the existing highway for safer access to the Project site is included.

The total infrastructure and buildings cost is estimated at US\$14.6 million.

21.1.2.11 *Supplier Engineering and Installation Supervision / Commissioning*

Supplier engineering costs have been included as part of equipment supply costs.

Costs for installation and commissioning supervision has been quoted by suppliers as either a fixed cost, cost per time period or has been included as part of the supply price and are considered for all major equipment items. Total cost for installation and commissioning supervision are estimated at US\$72,200. An additional allowance for vendor representatives is also included as part of the construction indirect costs.

21.1.2.12 *Process Mobile Equipment*

Mobile equipment included in the capital cost estimate are detailed in Table 21-8.

Table 21-8
Process Mobile Equipment

Description	Quantity
CAT D6 Dozer or Equiv.	1
Mechanical Service Truck	1
Forklift, 2.5 ton	3
Telehandler, 4 ton	1
Pickup Truck, ¾ ton	4
Backhoe w/ Fork Attachment, 1.1 cu. yd.	1
Boom Truck, 10 ton	1
Crane, 50 ton	1
Bobcat	1

Costs for process mobile equipment are based on cost guides or other published data. Mobile equipment costs are considered in the mechanical equipment cost estimate.

21.1.2.13 *Spare Parts*

Spare parts costs are estimated at 4.3% of the mechanical equipment supply costs. Total spare parts costs are estimated at US\$1.4 million.

21.1.2.14 *Process & Infrastructure Contingency*

Contingency for the process and infrastructure has been applied to the total direct costs by discipline. Contingency has been applied ranging from 5% to 20% as detailed in Table 21-9. The overall contingency for process and infrastructure is estimated at 13.1% of the direct costs.

**Table 21-9
Process & Infrastructure Contingency**

Direct Costs Contingency	%	Total (US\$)
Major Earthworks	15%	\$2,983,000
Civils (Supply & Install)	20%	\$920,000
Structural Steelwork	15%	\$0
Platework	15%	\$25,000
Mechanical Equipment	10%	\$3,901,000
Piping	15%	\$914,000
Electrical	15%	\$830,000
Instrumentation	15%	\$27,000
Infrastructure & Buildings	15%	\$2,187,000
Supplier Engineering	15%	\$0
Commissioning & Supervision	15%	\$9,000
Total Contingency on Direct Costs	13.1%	\$11,795,000

21.1.2.15 Process & Infrastructure Sustaining Capital

Sustaining capital for process and infrastructure includes the costs for the expansion of the heap leach pad and addition of an overland conveying equipment in Years 2 and 5 of operation, the addition of pit dewatering well pumps and evaporators for pit dewatering in Year 3 and the replacement of some of the process mobile equipment in Years 2, 4, 5, 7 and 8. Total sustaining capital is estimated at US\$22.6 million including contingency.

21.1.3 Construction Indirect Costs

Indirect field costs include construction services, quality control, survey support, warehouse and fenced yard operation, support equipment, etc. These costs have been estimated based on 18 months of field construction, contractor quotes, and reasonable allowances. Construction indirect costs are summarized in Table 21-10. A 20% contingency has been applied to the estimated construction indirect costs.

**Table 21-10
Construction Indirect Costs**

Indirect Field Costs	Total (US\$)
QA/QC Earthworks, Liner and Concrete	\$607,000
Preliminary Study Topography / Soil Mechanical	\$96,000
Surveying	\$186,000
Construction Equipment Rentals & Operating Costs	\$250,000
Office Equipment (copiers, Printers, Computers, Plotter)	\$80,000
Construction Warehouse Operation Crew	\$379,000
Electrical Verification Services	\$70,000
Mechanical and Piping Verification Services	\$23,000
Construction Power Opex and Rental	\$400,000
Portable Toilet Service	\$90,000
Sub Total Indirect Costs	\$2,181,000
Indirect Contingency, 20%	\$436,000
Total Indirect Costs	\$2,617,000

21.1.4 Other Owner's Construction Costs

Other Owner's construction costs are intended to cover the following items:

- Owner's costs for labour, offices, home office support, vehicles, travel and consultants during construction.
- Site security contractor.
- Concessions, water use fees, community relations, and environmental bonding costs.
- Subscriptions, licence fees, etc.
- Taxes and Permits.
- Work place health and safety costs during construction.

Other Owner's construction costs are estimated based on 18 months of site construction and are estimated at US\$ 17.5 million including a 10% contingency.

21.1.5 Working Capital

Working capital is money that is used to cover operating costs from start-up until a positive cash flow is achieved. Once a positive cash flow is attained, Project expenses will be paid from earnings. Working capital for the Project is estimated to be US\$9.0 million based on 60 days of

operation and includes all mine, process and G&A operating costs as well as process pre-production costs.

21.1.6 Initial Fills Inventory

The initial fills consist of consumable items stored on site at the outset of operations, which includes sodium cyanide (NaCN), lime, zinc, diatomaceous earth (DE), antiscalant, lead nitrate and fluxes. Initial fills are summarized in Table 21-11.

**Table 21-11
Initial Fills**

Item	Basis	Needed Weight kg or l	Truckloads	Quantity to Order kg or l	Unit Price US\$	Total Cost (Excluding IVA) US\$
NaCN	30 Days	262,500	13.1	260,000	2.50	\$650,000
Zinc	31 days	4,000	0.2	4,000	5.26	\$21,000
Diatomaceous Earth (D.E.)	30 days	54,810	2.7	60,000	1.16	\$70,000
Antiscalant	4 weeks	11,500	0.6	11,500	3.19	\$37,000
Lime (CaO)	full silo	120,000	6.0	120,000	0.15	\$18,000
Flux						
SiO ₂		2,000	0.1	2,000	0.50	\$1,000
Borax		2,000	0.1	2,000	0.98	\$2,000
Niter		2,000	0.1	2,000	1.75	\$3,500
Soda Ash		2,000	0.1	2,000	1.70	\$3,400
TOTAL						\$806,000

21.1.7 Engineering, Procurement & Construction Management

The estimated costs for engineering, procurement and construction management (EPCM) for the development, construction, and commissioning is US\$8.0 million based on Orla’s contract with the EPCM contractor and is inclusive of all change orders as of this date.

The EPCM costs cover services and expenses for the following areas:

- Project Management.
- Detailed Engineering.
- Engineering Support.
- Procurement.
- Construction Management.
- Commissioning.

- Vendors Reps.

For some major equipment packages, costs associated with detailed engineering, commissioning, and installation supervision have been included in the vendor's quotes; these costs are reflected in the supplier engineering or equipment supply costs of the capital costs estimate.

21.1.8 IVA

IVA is a value added tax which is applied at 16% to all goods and services in Mexico. IVA is not considered in the capital and operating costs; however, is included as part of the economic model. IVA is assumed to be completely refundable within one calendar year.

21.1.9 Exclusions

The following capital cost considerations have been excluded from the scope of supply and estimate:

- Finance charges and interests on corporate loans during construction.
- Escalation costs.
- Currency exchange fluctuations.

21.2 Operating Costs

Process operating costs for the Camino Rojo Project have been estimated based on information presented in earlier sections of this Technical Report. Mining costs were provided by IMC at US\$1.77 (excluding pre-production tonnes which are considered in the capital costs) per tonne mined (LOM US\$3.37 per tonne of ore processed) and are based on quotes for contract mining and blasting with estimated owner's mining costs.

Process operating costs have been estimated by KCA from first principles. Labour costs were estimated using project specific staffing, salary and wage and benefit requirements. Unit consumptions of materials, supplies, power, water and delivered supply costs were also estimated. LOM average processing costs are estimated at US\$3.20 per tonne ore.

General administrative costs (G&A) have been estimated by KCA with input from Orla. G&A costs include project specific labour and salary requirements and operating expenses including social contributions and land and water rights. G&A costs are estimated at US\$1.60 per tonne ore.

Mining costs were estimated based on updated firm proposals during the current EPCM work. Updated costs were received in the 3rd and 4th quarters of 2020 and are presented with no added

contingency based upon the design and operating criteria present in this Technical Report. IVA is not included in the operating cost estimate.

The operating costs presented are based upon the ownership of all process production equipment and site facilities, including the onsite laboratory. The owner will employ and direct all operating maintenance and support personnel for all site activities.

Operating costs estimates have been based upon information obtained from the following sources:

- Contractor mining quotes and owner mining costs from IMC;
- G&A costs estimated by KCA with input from Orla;
- Project metallurgical test work and process engineering;
- Supplier quotes for reagents and fuel
- Recent KCA project file data; and
- Experience of KCA staff with other similar operations.

Where specific data do not exist, cost allowances have been based upon consumption and operating requirements from other similar properties for which reliable data exist. Freight costs have been estimated where delivered prices were not available.

21.2.1 Mining Operating Costs

Mine operating costs are based on contractor quotes, owner mining personnel from first principles and estimated supplies and support services. Costs for pit dewatering have been estimated by KCA based on dewatering rates estimated by Ward (2020) and are included in the process operating costs. Total mine operating cost during commercial production is estimated at US\$226.7 million. This amounts to US\$1.77 per tonne of material mined and US\$3.37 per ore tonne processed.

There are some specific risks related to contract mining. There is risk that the contractor may need financial assistance from the owner either in terms of cash, or loan guarantees, to procure some equipment, increasing the capital cost. Contract mining is common in Mexico and risks can be reduced by careful selection of the contractor. LOM mining operating costs are presented in Table 21-12.

**Table 21-12
Contract Mining Cost Summary**

MINE OPERATING COST:	Units	PP	Yr1 Q1	Yr1 Q2	Yr1 Q3	Yr1 Q4	Year 2	Year 3	Year 4	Year 5	Year 6	Year 7	Year 8	Year 9	Year 10	Year 11	TOTAL
Mining Contractor	(\$x1000)	1,299	2,572	3,843	5,117	5,120	20,685	20,945	20,939	21,060	23,569	25,552	18,570	14,168	10,139	2,882	196,460
Blasting Contract	(\$x1000)	261	385	510	634	634	2,537	2,538	2,537	2,537	2,534	2,478	1,966	1,586	0	0	21,137
Technical Services Personnel	(\$x1000)	81	122	128	128	128	607	607	607	607	607	607	607	443	419	162	5,862
Technical Services Supplies	(\$x1000)	45	65	68	68	84	383	383	383	383	383	383	383	302	290	121	3,727
Controlled Blasting/Presplitting	(\$x1000)	0	0	0	0	0	54	121	120	152	194	235	153	140	0	0	1,170
TOTAL OPERATING COST - Commercial	(\$x1000)		3,144	4,549	5,948	5,967	24,267	24,594	24,587	24,740	27,287	29,255	21,680	16,639	10,848	3,165	226,670
TOTAL OPERATING COST - Development	(\$x1000)	1,686															1,686
Total Material	(kt)		2,009	3,002	3,998	4,000	15,999	16,002	15,999	15,999	15,971	15,528	11,430	8,386	0	0	128,323
Total Ore	(kt)	0	822	1,643	1,643	1,643	6,569	6,571	6,571	6,570	6,571	6,569	6,571	6,570	6,570	2,414	67,297
Cost Per Total Tonne	(US\$/t)		1.565	1.515	1.488	1.492	1.517	1.537	1.537	1.546	1.709	1.884	1.897	1.984	0.000	0.000	1.766
Cost Per Ore Tonne	(US\$/t)	0.000	3.825	2.768	3.620	3.632	3.694	3.743	3.742	3.766	4.153	4.454	3.299	2.532	1.651	1.311	3.368

21.2.1.1 *Contract Mining Cost Basis*

Contract mining costs are based on contractor quotes and are summarized in Table 21-13. The quoted contract mining rate is US\$1.28/t for pre-production through Year 5, \$1.429/t for Year 6, \$1.588/t for Year 7, \$1.573/t for Year 8 and \$1.591/t for Year 9 and does not distinguish by material type for ex-pit material. The higher unit costs for Years 6 through 9 are based on a deeper pit and longer truck hauls. The contractor rate for rehandling ore stockpiles are US\$1.127/t for Year 9 and US\$1.194/t during Years 10 and 11. Waste rehandle to encapsulate sulphide and transition material is estimated at US\$0.806/t during Year 10.

Costs for drilling for pre-splitting and wall control have been quoted by the mining contractor at US\$10.09/m. Based on the estimated requirement of 20,632 holes and 443,572m of drilling, this amounts to US\$4.48 million over the life of the mine.

The life of mine estimate for contract mining, including pre-split drilling, is US\$196.5 million.

21.2.1.2 *Blasting & Mine Technical Services Costs*

Costs for blasting are based on contractor quotes and are summarized in Table 21-14. The blasting agents and services contract includes costs to load and detonate the blast holes. The quotation is based on a cost of US\$0.125 per tonne for blasting supplies and a fixed cost of US\$44,772 per month for services. The life of mine estimate for blasting amounts to about US\$0.163 per total tonne blasted.

Mine technical services and supplies includes the cost for engineering, geology, surveying and grade control personnel, and an allowance for supplies and is summarized in Table 21-15 by time period. It is assumed that the chief engineer will be the primary contact for the mining and blasting contractors. The estimate also includes an allowance of 50% of the personnel costs for supplies and consumables. This is to cover office supplies, fuel and repairs for the pickups, repair and maintenance costs for office equipment, training, conventions, consultant reviews, etc.

There is also a separate line item for major software support. MineSight support has been quoted at 20% of the initial purchase price per year which amounts to US\$64,000 per year. The first-year subscription is included in the purchase price, so this charge does not start until the 4th quarter of Year 1. The subscription cost for one Leapfrog key is US\$13,000 per year and two AutoCAD seats are about US\$3,000 per year (US\$1,500 each). These are US\$16,000 per year or US\$4,000 per quarter. Personnel plus supplies costs amount to US\$9.59 million over the Project life.

Table 21-13
Contract Mining Costs Based on Unit Rates

Material Type	Units	PP	Yr1 Q1	Yr1 Q2	Yr1 Q3	Yr1 Q4	Year 2	Year 3	Year 4	Year 5	Year 6	Year 7	Year 8	Year 9	Year 10	Year 11	TOTAL
Unit Rates:																	
Leach	(US\$/t)	1.280	1.280	1.280	1.280	1.280	1.280	1.280	1.280	1.280	1.429	1.588	1.573	1.591			1.399
Low Grade	(US\$/t)	1.280	1.280	1.280	1.280	1.280	1.280	1.280	1.280	1.280	1.429	1.588	1.573	1.591			1.321
Overburden	(US\$/t)	1.280	1.280	1.280	1.280	1.280	1.280	1.280	1.280	1.280	1.429	1.588	1.573	1.591			1.295
Waste	(US\$/t)	1.280	1.280	1.280	1.280	1.280	1.280	1.280	1.280	1.280	1.429	1.588	1.573	1.591			1.397
Rehandle	(US\$/t)													1.127	1.194	1.194	1.181
Waste Rehandle	(US\$/t)														0.806		
Total Cost:																	
Leach	(\$x1000)	192	945	2,103	2,103	2,103	8,408	8,411	8,411	8,410	9,392	10,429	10,339	10,038	0	0	81,283
Low Grade	(\$x1000)	23	28	644	481	899	3,429	1,517	1,277	1,005	2,035	875	0	0	0	0	12,213
Overburden	(\$x1000)	1,060	1,020	389	202	22	4,069	4,424	3,151	1,599	2,037	0	0	0	0	0	17,973
Waste	(\$x1000)	24	579	707	2,331	2,097	4,572	6,131	7,639	9,466	9,363	13,349	7,645	3,300	0	0	67,203
Rehandle	(\$x1000)	0	0	0	0	0	0	0	0	0	0	0	0	292	7,843	2,882	11,017
Waste Rehandle	(\$x1000)														2,296		2,296
Presplit Drilling@	10.09 (\$x1000)	0	0	0	0	0	207	462	461	581	743	899	586	537	0	0	4,476
Total Cost	(\$x1000)	1,299	2,572	3,843	5,117	5,120	20,685	20,945	20,939	21,060	23,569	25,552	18,570	14,168	10,139	2,882	196,460
Cost Per Ore Tonne	(US\$)	0.000	3.128	2.339	3.115	3.116	3.149	3.187	3.187	3.205	3.587	3.890	2.826	2.156	1.543	1.194	2.919
Cost Per Total Tonne (Ex-Pit)	(US\$)	1.280	1.280	1.280	1.280	1.280	1.293	1.309	1.309	1.316	1.476	1.646	1.625	1.689	0.000	0.000	1.519

Table 21-14
Contract Blasting Costs Based on Unit Rates

Description	Units	PP	Yr1 Q1	Yr1 Q2	Yr1 Q3	Yr1 Q4	Year 2	Year 3	Year 4	Year 5	Year 6	Year 7	Year 8	Year 9	TOTAL
Ex-Pit Ktonnes	(kt)	1,015	2,009	3,002	3,998	4,000	15,999	16,002	15,999	15,999	15,971	15,528	11,430	8,386	129,338
Blasting Supplies @	0.125 /tonne (\$x1000)	127	251	375	500	500	2,000	2,000	2,000	2,000	1,996	1,941	1,429	1,048	16,167
Months/Period	(months)	3	3	3	3	3	12	12	12	12	12	12	12	12	111
Services @ US\$	44,772 /month (\$x1000)	134	134	134	134	134	537	537	537	537	537	537	537	537	4,970
Total Cost	(\$x1000)	261	385	510	634	634	2,537	2,538	2,537	2,537	2,534	2,478	1,966	1,586	21,137
Cost Per Ex-Pit Tonne	(US\$)	0.257	0.192	0.170	0.159	0.159	0.159	0.159	0.159	0.159	0.159	0.159	0.160	0.172	0.189

**Table 21-15
Owner Mine Personnel & Technical Services**

JOB DESCRIPTION	Unit	Year															Total
		PP	Y1Q1	Y1Q2	Y1Q3	Y1Q4	2	3	4	5	6	7	8	9	10	11	
TECHNICAL SERVICES:																	
Chief Mining Engineer	Persons	1	1	1	1	1	1	1	1	1	1	1	1	1	1	1	1
Mining Engineer	Persons	1	2	2	2	2	3	3	3	3	3	3	3	2	2	1	
Chief Geologist	Persons	0	0	0	0	0	0	0	0	0	0	0	0	0	0	0	0
Geologist	Persons	1	2	2	2	2	2	2	2	2	2	2	2	1	1	1	
Chief Surveyor	Persons	1	1	1	1	1	1	1	1	1	1	1	1	1	1	1	
Technicians	Persons	1	2	3	3	3	4	4	4	4	4	4	4	3	2	1	
Mine Technical Services Total		5	8	9	9	9	11	11	11	11	11	11	11	8	7	5	
TOTAL PERSONNEL		5	8	9	9	9	11	11	11	11	11	11	11	8	7	5	
Mine Technical Services Total	\$x1000	81.4	122.3	128.3	128.3	128.3	606.9	606.9	606.9	606.9	606.9	606.9	606.9	443.4	419.4	162.3	5,862
Supplies/Consumables @ 50%	\$x1000	40.7	61.1	64.1	64.1	64.1	303.5	303.5	303.5	303.5	303.5	303.5	303.5	221.7	209.7	81.2	2,931
Software Support	\$x1000	4.0	4.0	4.0	4.0	20.0	80.0	80.0	80.0	80.0	80.0	80.0	80.0	80.0	80.0	40.0	796
TOTAL	\$x1000	126.1	187.4	196.4	196.4	212.4	990.4	990.4	990.4	990.4	990.4	990.4	990.4	745.1	709.0	283.5	9,589
Partial Year Factor		25.0%	25.0%	25.0%	25.0%	25.0%	100.0%	100.0%	100.0%	100.0%	100.0%	100.0%	100.0%	100.0%	100.0%	49.9%	

21.2.2 Process and G&A Operating Costs

Average annual process and G&A operating costs are presented in Table 21-16.

Table 21-16
Average Process, Support & G&A Operating Cost

	Annual Costs, US\$	US\$ per Tonne Ore
Labor		
Process	\$1,907,741	\$0.294
Laboratory	\$353,637	\$0.054
SUBTOTAL	\$2,261,378	\$0.35
Crushing		
Power	\$1,226,923	\$0.189
992 Loader	\$871,487	\$0.134
Wear	\$1,285,577	\$0.198
Overhaul & Maintenance	\$642,789	\$0.099
SUBTOTAL	\$4,026,775	\$0.62
Reclaim & Convey/Stacking		
Power	\$1,642,683	\$0.253
D-6 Dozer	\$278,644	\$0.043
Maintenance Supplies	\$321,394	\$0.049
SUBTOTAL	\$2,242,721	\$0.35
Heap Leach Systems		
Power	\$737,905	\$0.114
Piping	\$192,837	\$0.030
Maintenance Supplies	\$64,279	\$0.010
SUBTOTAL	\$995,020	\$0.15
Merrill-Crowe		
Power	\$199,452	\$0.031
DE	\$601,156	\$0.093
Zinc	\$336,175	\$0.052
Lead Nitrate	\$36,814	\$0.006
Filter Cloths (Press)	\$96,000	\$0.015
Filter Cloths (Clarifier)	\$32,000	\$0.005
Misc. Operating Supplies	\$128,558	\$0.020
SUBTOTAL	\$1,430,155	\$0.22
Refinery		
Power	\$106,688	\$0.016
Misc. Operating Supplies	\$128,558	\$0.020
Maintenance Supplies	\$64,279	\$0.010
SUBTOTAL	\$299,525	\$0.05
Reagents		
Power	\$15,006	\$0.002
Lime	\$1,229,333	\$0.189
Cyanide (Ore)	\$5,624,400	\$0.866
Antiscalant	\$546,250	\$0.084
Fluxes	\$68,446	\$0.011
Maintenance Supplies	\$64,279	\$0.010

	Annual Costs, US\$	US\$ per Tonne Ore
SUBTOTAL	\$7,547,714	\$1.16
Water Supply & Distribution		
Power	\$141,303	\$0.022
Pit Dewatering Treatment	\$159,932	\$0.025
Maintenance Supplies	\$177,720	\$0.027
SUBTOTAL	\$478,956	\$0.07
Laboratory		
Power	\$226,583	\$0.035
Assays, Solids	\$379,186	\$0.058
Assays, Solutions	\$109,500	\$0.017
Misc. Supplies	\$128,558	\$0.020
SUBTOTAL	\$843,826	\$0.13
Support Services / Facilities		
Power	\$200,068	\$0.031
Fork Lift, 2.5 t	\$14,159	\$0.002
Telehandler	\$33,051	\$0.005
Boom Truck 10 t	\$15,011	\$0.002
Backhoe/loader	\$47,846	\$0.007
Pickup Trucks (4)	\$192,512	\$0.030
Maintenance Truck	\$29,878	\$0.005
Crane - Rough Terrain	\$10,649	\$0.002
Bobcat	\$17,280	\$0.003
Maintenance Supplies	\$128,558	\$0.020
SUBTOTAL	\$689,011	\$0.11
TOTAL COST (w/o contingency)	\$20,815,082	\$3.204
Sub-TOTAL COST (process Only excluding IVA)	\$20,815,082	\$3.204
G&A		
G&A Labor	\$1,987,915	\$0.306
G&A Expenses	\$6,189,778	\$0.953
Land Access Agreements	\$648,035	\$0.100
Water Rights	\$173,255	\$0.027
Water Usage	\$531,244	\$0.082
Concessions	\$158,336	\$0.024
TOTAL COST G&A	\$9,688,564	\$1.491
TOTAL COST (excluding IVA)	\$30,503,646	\$4.695

*Note: Average G&A does not include G&A costs during the reclamation and closure period.

21.2.2.1 Personnel and Staffing

Staffing requirements for process and administration personnel have been estimated by KCA based on experience with similar sized operations with input from Orla on wages and salary information. Staffing will be primarily by Mexican nationals with an emphasis of hiring as many workers from the local communities as possible. Total process personnel are estimated at 82 persons including 13 laboratory workers. G&A labour is estimated at 57 persons plus an additional 11 support personnel included in the mine cost estimate. Mining labour will be provided by the mining contractor and is considered in the mining cost estimate.

Personnel requirements and costs are estimated at US\$4.2 million per year and are summarized in Table 21-17.

**Table 21-17
Personnel & Staffing Summary**

Description	Number of Workers	Cost US\$/yr
Process Supervision	10	\$719,000
Crushing & Reclaim	12	\$246,000
Heap Leach	17	\$315,000
Recovery Plant	11	\$210,000
Maintenance	19	\$433,000
Subtotal Process	69	\$1,923,000
Laboratory	13	\$362,000
G&A	57	\$1,944,000
TOTAL	139	\$4,228,000

21.2.2.2 Power

Power usage for the process and process-related infrastructure was derived from estimated connected loads assigned to powered equipment from the mechanical equipment list. Equipment power demands under normal operation were assigned and coupled with estimated on-stream times to determine the average energy usage and cost. Power requirements for the Project are presented in Table 18-2 in Section 18 of this Technical Report excluding pit dewatering power requirements. Attached power for pit dewatering is estimated at 296 kW with demand varying based on pit dewatering requirements.

The total attached power for the process and infrastructure is estimated at 8.9 MW, with an average draw of 5.2 MW at start up increasing to 9.5 MW attached with a demand of 5.4 MW by Year 5 of operations (not including pit dewatering). Power will be supplied by an overhead powerline with an average estimated cost of US\$0.10/kWh. Construction of the powerline to site is currently 49% complete.

21.2.2.3 Consumable Items

Operating supplies have been estimated based upon unit costs and consumption rates predicted by metallurgical tests and have been broken down by area. Freight costs are included in all operating supply and reagent estimates. Reagent consumptions have been derived from test work and from design criteria considerations. Other consumable items have been estimated by KCA based on KCA's experience with other similar operations.

Operating costs for consumable items have been distributed based on tonnage and gold/silver production or smelting batches, as appropriate.

21.2.2.4 Heap Leach Consumables

Pipes, Fittings and Emitters – The heap pipe costs include expenses for broken pipe, fittings and valves, and abandoned tubing. The heap pipe costs are estimated to be US\$0.03/t ore, and are based on previous detailed studies conducted by KCA on similar projects.

Sodium Cyanide (NaCN) – Delivered sodium cyanide is quoted at US\$2.50/kg. Cyanide is primarily consumed in the heap leach at 0.35 kg/t ore.

Pebble Lime (CaO) – Pebble lime is consumed at an average rate of 1.25 kg/t ore for pH control at the heap. A delivered price of US\$153/t has been quoted.

Antiscale Agent (Scale Inhibitor) – Antiscalant consumption is based on a dosage range of 0 to 20 ppm to the suctions of the barren and pregnant pumps. A delivered price of US\$2.48/kg has been used based on recent supplier quotes in KCA's files.

21.2.2.5 Recovery Plant Consumables

Filter Cloths – Filter cloths for the clarification and precipitation filter presses must be replaced periodically. It is assumed that filter cloths will be replaced three times per year for the clarification filters and once per year for the precipitation filter presses. An allowance of US\$8,000 per set of filter cloths has been used for this Technical Report based on recent information in KCA's files.

Zinc – Ultra-fine zinc dust will be consumed in the recovery plant at an assumed rate of 3 kg zinc per kg of metal in solution which will vary based on recovery plant efficiencies. Zinc is quoted at US\$5.00 per kg. A US\$0.258/kg allowance has been added for delivery to the Project site.

Lead Nitrate – Lead nitrate is used to improve Merrill-Crowe recovery efficiency and is consumed at approximately 10% of the zinc consumption if required. Lead nitrate has been quoted at US\$5.50/kg. A US\$0.258/kg allowance has been added for delivery to the Project site.

Diatomaceous Earth – Diatomaceous earth (DE) is used as a filter media in the recovery plant. DE consumption is based on one precoat per day for each of the clarification and precipitation filter presses as well as body feed to each of the filter systems. Diatomaceous earth has been quoted at US\$0.91/kg. A US\$0.258/kg allowance has been added for delivery to the Project site.

Smelting Fluxes - It has been estimated that 0.054 kg of mixed fluxes per troy ounce of precious metal produced will be required. The estimated delivered cost of these fluxes, which includes borax, silica, niter, and soda ash, is US\$1.85/kg, which is based on quoted costs and assumed flux composition. A US\$0.258/kg allowance has been added for delivery to the Project site.

21.2.2.6 *Laboratory*

Fire assaying and solution assaying of samples will be conducted in the on-site laboratory. It is estimated that approximately 150 solids assays and 100 solution assays at US\$7 and US\$3 per assay, respectively, will need to be performed each day.

21.2.2.7 *Fuel*

Diesel fuel will be required for heavy equipment operation and vehicles. Diesel is quoted at US\$0.88/L, not including IVA.

21.2.2.8 *Miscellaneous Operating & Maintenance Supplies*

Overhaul and maintenance of equipment along with miscellaneous operating supplies for each area have been estimated as allowances based on tonnes of ore processed. The allowances for each area were developed based on published data as well as KCA's experience with similar operations.

Maintenance and operating supplies costs are estimated at US\$0.470 per tonne ore processed.

21.2.2.9 *Mobile / Support Equipment*

Mobile and support equipment are required for the process and include three fork lifts, one 4-t telehandler with boom extension, one 10-t boom truck, one backhoe, four pickup trucks, one maintenance truck, one 50-t rough terrain crane and an ambulance. The costs to operate and maintain each piece of equipment have been estimated primarily using published information and project specific fuel costs. Where published information was not available, allowances were made based on KCA's experience from similar operations.

Support equipment annual operating costs are estimated at US\$360,000 or US\$0.055 per tonne of ore. Support equipment operating costs are presented in Table 21-18.

Table 21-18
Support Equipment Operating Costs

Description	Unit	Qty.	Unit Cost	Annual Cost, US\$
Fork Lift, 2.5 t	h/mo	180	\$6.55	\$14,200
Telehandler	h/mo	120	\$22.95	\$33,000
Boom Truck 10 t	h/mo	90	\$13.90	\$15,000
Backhoe/loader	h/mo	180	\$22.15	\$47,900
Pickup Trucks (4)	km/d	350	\$1.48	\$192,500
Maintenance Truck	km/d	100	\$0.82	\$29,900
Crane - Rough Terrain	h/mo	24	\$36.97	\$10,600
Bobcat	h/mo	180	\$8.00	\$17,300
TOTAL				\$360,400

21.2.2.10 G&A Expenses

General and administrative expenses are expected to average US\$6.1 million per year and include costs for water and land access rights, mining, concessions, offsite offices, insurance, office supplies, communications, environmental and social management, health and safety supplies, security, travel and camp operations. For the cost estimate G&A expenses are represented primarily as fixed costs or have been structured based on existing agreements between Orla and the surrounding communities. Fixed G&A expenses are presented in Table 21-19. Total G&A expenses by year are presented in Table 21-20.

**Table 21-19
Fixed G&A Expenses**

Description	Total Annual
Administration	
Community Obligations	\$644,800
Computers and Telecom	\$66,187
Equipment	\$110,400
Facilities	\$6,240
Facilities	\$34,374
Government	\$181,200
Insurance	\$1,186,800
Mineral Rights	\$141,600
Professional	\$547,300
Travel	\$43,500
Camp	
Computers and Telecom	\$17,656
Equipment	\$39,429
Facilities	\$99,264
Food and Supplies	\$427,873
Maintenance	\$8,000
Other G&A Costs	\$53,368
Security	\$537,609
Travel	\$24,918
Community & Social Relations	
Community Events	\$32,857
Computer and Telecom	\$9,344
Consultants	\$192,000
CSR Initiatives	\$1,028,857
CSR Payments	\$101,263
Other G&A Costs	\$857
Vehicles	\$38,009
Environment, Health & Safety	
Computers and Telecom	\$13,800
Env. Monitoring	\$63,257
Environmental	\$68,751
Facilities	\$19,275
Insurance	\$102,876
Other G&A Costs	\$8,500
Permits	\$68,670
Support for Security	\$64,458
Travel	\$7,440
Vehicles	\$71,758
Sub-Total	\$6,107,691

**Table 21-20
G&A Expenses by Year**

	Y1	Y2	Y3	Y4	Y5	Y6	Y7	Y8	Y9	Y10	Y11	Y12	Y13/14
Fixed Costs	\$6,107,691	\$6,107,691	\$6,107,691	\$6,107,691	\$6,107,691	\$6,107,691	\$6,107,691	\$6,107,691	\$6,107,691	\$6,107,691	\$3,095,171	\$1,345,358	\$861,736
Land Access Agreements	\$610,769	\$610,769	\$610,769	\$610,769	\$610,769	\$610,769	\$610,769	\$610,769	\$610,769	\$610,769	\$610,769	\$610,769	\$610,769
Water Rights	\$243,864		\$263,764		\$285,287		\$308,566		\$333,745		\$360,979		
Water Usage	\$408,458	\$424,781	\$441,755	\$459,409	\$477,767	\$496,859	\$516,715	\$537,363	\$558,858	\$581,212	\$604,460	\$39,290	\$40,862
Concessions	\$149,231	\$149,231	\$149,231	\$149,231	\$149,231	\$149,231	\$149,231	\$149,231	\$149,231	\$149,231	\$149,231	\$149,231	\$149,231
Total	\$7,520,013	\$7,292,471	\$7,573,210	\$7,327,099	\$7,630,744	\$7,364,550	\$7,692,971	\$7,405,054	\$7,760,293	\$7,448,902	\$4,820,610	\$2,144,648	\$1,662,598

21.3 Reclamation & Closure Costs

A cost estimate for reclamation and closure was made by KCA with input from IMC. Costs for reclamation and closure were estimated to be US\$28.6 million and are based on a 5-year closure period (plus ongoing monitoring) and are summarized in Table 20-1. The costs include work to be conducted from the closure of the mine, end of operation activities and concurrent rehabilitation work, excluding G&A costs during closure. G&A costs during closure are estimated at US\$7.6 million and are included in the operating costs estimate.

The main objectives of the reclamation and closure plan include:

- Progressive rehabilitation to allow rapid recovery of the vegetation cover and early recovery of the ecosystem;
- Sustainability of rehabilitation work including water and wind erosion;
- Recovery of land uses; and
- Implementation of a post-closure monitoring program.

Activities included as part of reclamation and closure are described in Section 20 of this Technical Report.

22.0 ECONOMIC ANALYSIS

22.1 Summary

Based on the estimated production schedule, capital costs and operating costs, a cash flow model was prepared by KCA for the economic analysis of the Project. All of the information used in this economic evaluation has been taken from work completed by KCA and other consultants working on this Project as described in previous sections of this Technical Report. Economics detailed in this section are based solely on the Project itself and do not consider any potential mineralization extracted from the Fresnillo mineral concession as this material has been treated as waste material for the purpose of this Technical Report.

The Project economics were evaluated using a discounted cash flow (DCF) method, which measures the Net Present Value (NPV) of future cash flow streams. The results of the economic analysis represent forward-looking information as defined under Canadian securities law. The results depend on inputs that are subject to a number of known and unknown risks, uncertainties and other factors that may cause actual results to differ materially from those presented here.

Construction activities for the Camino Rojo Project are currently in progress at the time of the writing of this Technical Report. All costs related to project development are included in the pre-production capital estimate, including those already spent as of the date of this study. Capital already spent has been included in the Year-1 totals but are not discounted. This gives the best estimate of the project NPV and IRR as of the date of this Technical Report.

The final economic model was developed by KCA based on the following assumptions:

- The cash flow model is based on the mine production schedule from IMC.
- The period of analysis is fifteen years including one year of investment and pre-production, 11 years of production and three years for reclamation and closure. Project development costs spent to date are included in the pre-production period but are not discounted.
- Gold price of US\$1,600/oz as discussed in Section 19.0 of this Technical Report.
- Silver price of US\$20/oz as discussed in Section 19.0 of this Technical Report.
- Processing rate of 18,000 tpd as discussed in Section 16.1 of this Technical Report.
- Overall recoveries of 62% for gold and 20% for silver as discussed in Section 13.4 of this Technical Report.
- Capital and operating costs as developed in Section 21.0 of this Technical Report.

The key economic parameters are presented in Table 22-1 and the economic summary is presented in Table 22-2.

**Table 22-1
Key Economic Parameters**

Item	Value	unit
Au Price	1600	US\$/oz
Ag Price	20	US\$/oz
Au Avg. Recovery	62	%
Ag Avg. Recovery	20	%
Treatment Rate	18,000	tpd
Refining & Transportation Cost, Au	1.40	US\$/oz
Refining & Transportation Cost, Ag	1.20	US\$/oz
Payable Factor, Au	99.9	%
Payable Factor, Ag	98.0	%
Annual Produced Au, Avg.	94	koz
Annual Produced Ag, Avg.	597	koz
Income & Corporate Tax Rate	30	%
Special Mining Tax Rate	7.5	%
Royalties		
Mine Claim	2.0	%
Extraordinary Mining Duty	0.5	%

**Table 22-2
Economic Analysis Summary**

Production Data		
Life of Mine	10.4	Years
Mine Throughput per day	18,000	Tonnes Ore /day
Mine Throughput per year	6,570,000	Tonnes Ore /year
Total Tonnes to Crusher	67,363,000	Tonnes Ore
Grade Au (Avg.)	0.73	g/t
Grade Ag (Avg.)	14.55	g/t
Contained Au oz	1,588,000	Ounces
Contained Ag oz	31,506,000	Ounces
Metallurgical Recovery Au (Overall)	62%	
Metallurgical Recovery Ag (Overall)	20%	
Average Annual Gold Production	94,000	Ounces
Average Annual Silver Production	597,000	Ounces
Total Gold Produced	980,000	Ounces
Total Silver Produced	6,189,000	Ounces
LOM Strip Ratio (W:O)	0.92	
Operating Costs (Average LOM)		
Mining (including preproduction tonnes)	\$1.75	/Tonne mined
Mining (processed)	\$3.37	/Tonne Ore processed
Processing & Support	\$3.20	/Tonne Ore processed
G&A	\$1.60	/Tonne Ore processed
Total Operating Cost	\$8.17	/Tonne Ore processed
Total By-Product Cash Cost	\$490	/Ounce Au
All-in Sustaining Cost	\$543	/Ounce Au
Capital Costs (Excluding IVA and Closure)		
Initial Capital	\$134	million
LOM Sustaining Capital	\$24	million
Total LOM Capital	\$158	million
Working Capital & Initial Fills	\$10	million
Closure Costs	\$29	million
Financial Analysis		
Gold Price Assumption	\$1,600	/Ounce
Silver Price Assumption	\$20	/Ounce
Average Annual Cashflow (Pre-Tax)	\$106	million
Average Annual Cashflow (After-Tax)	\$79	million
Internal Rate of Return (IRR), Pre-Tax	82.4%	
Internal Rate of Return (IRR), After-Tax	61.8%	
NPV @ 5% (Pre-Tax)	\$668	million
NPV @ 5% (After-Tax)	\$452	million
Pay-Back Period (Years based on After-Tax)	1.5	Years

22.2 Methodology

The Camino Rojo Project economics are evaluated using a discounted cash flow method. The DCF method requires that annual cash inflows and outflows are projected, from which the resulting net annual cash flows are discounted back to the Project evaluation date. Considerations for this analysis include the following:

- The cash flow model has been developed by KCA with input from Orla.
- The cash flow model is based on the mine production schedule from IMC.
- Gold and silver production and revenue in the model are delayed from the time ore is stacked based on the mine production schedule and leach curves to account for time required for metal values to be recovered from the heap.
- The period of analysis is fifteen years including one year of investment and pre-production, 11 years of production and three years for reclamation and closure. Project development costs spent to date are included in the pre-production period but are not discounted.
- All cash flow amounts are in US dollars (US\$). Updated mining and process costs from current EPCM and construction activities are based on 4th quarter 2020 US dollars. All other costs are unchanged from the 2019 Technical Report and are considered to be 3rd and 4th quarter 2019 costs. Inflation is not considered in this model with the exception of inflationary adjustment on depreciation pool balances as permitted under Mexican law.
- The Internal Rate of Return (IRR) is calculated as the discount rate that yields a zero NPV.
- The NPV is calculated by discounting the annual cash back to Year -1 at different discount rates. All annual cash flows are assumed to occur at the end of each respective year. Process development costs spent to date are not discounted, but are included in the final NPV values.
- The payback period is the amount of time, in years, required to recover the initial construction capital cost.
- Working capital and initial fills are considered in this model and include mining, processing and general administrative operating costs. The model assumes working capital and initial fills are recovered during the final two years of operation.
- Royalties and government taxes are included in the model.
- The model is built on an unlevered basis.
- Property acquisition costs are not included in the economic analysis.
- Salvage value for process equipment is considered and is applied at the end of the Project.
- Reclamation and closure costs are included.

The economic analysis is performed on a before and after-tax basis in constant dollar terms, with the cash flows estimated on a project basis.

22.2.1 General Assumptions

General assumptions for the model, including cost inputs, parameters, royalties and taxes are as follows:

- Basic and detailed engineering and site construction currently in progress as of the date of this Technical Report.
- First gold pour occurs fourth quarter 2021.
- Gold price of US\$1600/oz is used as the base case price.
- Silver price of US\$20/oz as the base price.
- Gold and silver production and revenue in the model are delayed from the time material is stacked based on the mine production schedule and material leach curves to account for time required for gold to be recovered from the heap. An additional month of delay is added beginning in Year 5 to reflect additional delays from higher lifts.
- LOM average operating costs of US\$8.17/t ore including a mining cost of US\$3.37/t ore, processing cost of US\$3.20/t ore and G&A cost of US\$1.60/t ore.
- Pre-production capital costs for the Project are spent entirely in Year -1, including the cost for the site powerline to site. Sustaining capital for the heap leach pad expansions is spent in Year 2 and Year 5. Sustaining capital for evaporators for treatment of pit water is spent in Year 3. Sustaining capital for replacement of some process mobile equipment is spent in Years 2, 4, 5 and 7.
- Working capital equal to 60 days of operating costs during the pre-production and ramp up period is included for mining, process and G&A costs as well as initial fills for process reagents and consumables. The assumption is made that all working capital and initial fills can be recovered in the final years of operation and the effective sum of working capital and initial fills over the life of mine is zero.
- Depreciation allowances for eligible items are included in the model based on straight line depreciation schedules up to the maximum allowed under Mexican law, including 3% annual inflation adjustment on depreciation pool balances.
- IVA is applied at 16% to all capital costs as a part of this model and is assumed to be 100% refundable the following year. IVA is not applied to operating costs.
- A 2% NSR royalty is included based on current royalty agreement.
- A 0.5% royalty is included and payable to the government as an “extraordinary mining duty”.
- An income tax of 30% is considered.
- A 7.5% mining tax is included and is based on EBITDA less exploration and deductible earthworks costs.
- Possibly forthcoming Zacatecas Environmental “Green Tax” is not considered.

- A refinery and transportation cost of US\$1.40/oz for gold and US\$1.20/oz for silver is used in the model, including insurance. Gold and silver are assumed to be 99.9% and 98% payable, respectively.
- A loss carry forward of US\$3.3 million represents general and administrative costs incurred to date.
- Total depreciation of US\$255 million is considered and divided into three categories:
 - i. Pre-production exploration costs of US\$122.2 million, which includes US\$24 million for the acquisition of the mining concessions, US\$62.8 million for the Layback Agreement and US\$35.5 million for exploration costs incurred to date. Pre-production exploration costs are assumed to be depreciable using the straight-line method over a 10-year period.
 - ii. Pre-production development costs of \$25.6 million, which include owner's costs and EPCM costs. Pre-production development costs are assumed to be depreciable using the straight-line method over a 10-year period.
 - iii. Fixed assets costs of US\$107.2 million, which includes a significant portion of the direct costs for the project. Fixed assets costs are assumed to be depreciable using the straight-line method at 12% annually.
- By-product cash operating costs per payable ounce represent the mine site operating costs including mining, processing, metal transport, refining, administration costs and royalties with a credit for silver produced. Operating costs are presented in greater detail in Section 21 of this Technical Report.
- All in sustaining costs per payable ounce represent the mine site operating costs including mining, processing, metal transport, refining, administration costs and royalties with a credit for silver produced as well as the LOM sustaining capital and reclamation and closure costs.
- The cash flow analysis evaluates the Project on a stand-alone basis. No property acquisition costs, withholding taxes or dividends are included. No head office or overheads for the parent company are included.

22.3 Capital Expenditures

Capital expenditures include initial capital (pre-production or construction costs), sustaining capital and working capital. The capital expenditures are presented in detail in Section 21 of this Technical Report.

The capital expenditures for the Project are summarized in Table 22-3.

**Table 22-3
Capital Expenditures Summary**

Capital Item	LOM Cost (US\$)
Pre-Production Stripping (incl. Mobilization)	\$2,850,000
Owner Equipment	\$786,000
Major Earthworks	\$18,976,000
Liner / Materials (Supply & Install)	\$12,402,000
Civils (Supply & Install)	\$4,599,000
Structural Steel (Supply & Install)	incl.
Platework (Supply)	\$120,000
Platework (Install)	\$47,000
Mechanical Equipment (Supply)	\$41,795,000
Mechanical Equipment (Install)	\$5,139,000
Piping (Supply & Install)	\$6,589,000
Electrical (Supply)	\$4,934,000
Electrical (Install)	\$602,000
Instrumentation (Supply & Install)	\$180,000
Infrastructure (Supply & Install)	\$14,577,000
Spare Parts	\$1,449,000
Freight & Duties	incl
Process Contingency	\$14,386,000
EPCM	\$8,020,000
Commissioning & Supervision	\$57,000
Supplier Engineering	incl.
Indirect Costs (incl. contingency)	\$2,617,000
Owner's Costs (incl. contingency)	\$17,495,000
Subtotal	\$157,621,000
Working Capital (Initial Fills)	\$806,000
Working Capital (60 days)	\$8,826,000
Process Preproduction	\$213,000
TOTAL (Excluding IVA)	\$167,467,000

The economic model assumes working capital and initial fills will be recovered at the end of the operation and are applied as credits against the capital cost. Working capital and initial fills are assumed to be recovered during Years 10 and 11. Salvage value for equipment is considered as taxable income and is applied during Years 12 through 14 after equipment items are no longer in service. Costs presented in Table 22-3 do not include the recovery of working capital or salvage income.

22.4 Metal Production

Total metal production for the Camino Rojo oxide deposit is estimated at 980,000 ounces of recovered gold and 6.2 million ounces of recovered silver. Annual production profiles for gold and silver are presented in Figure 22.1 and Figure 22.2, respectively with 94,000 ounces of gold and 597,000 ounces of silver being recovered annually on average.

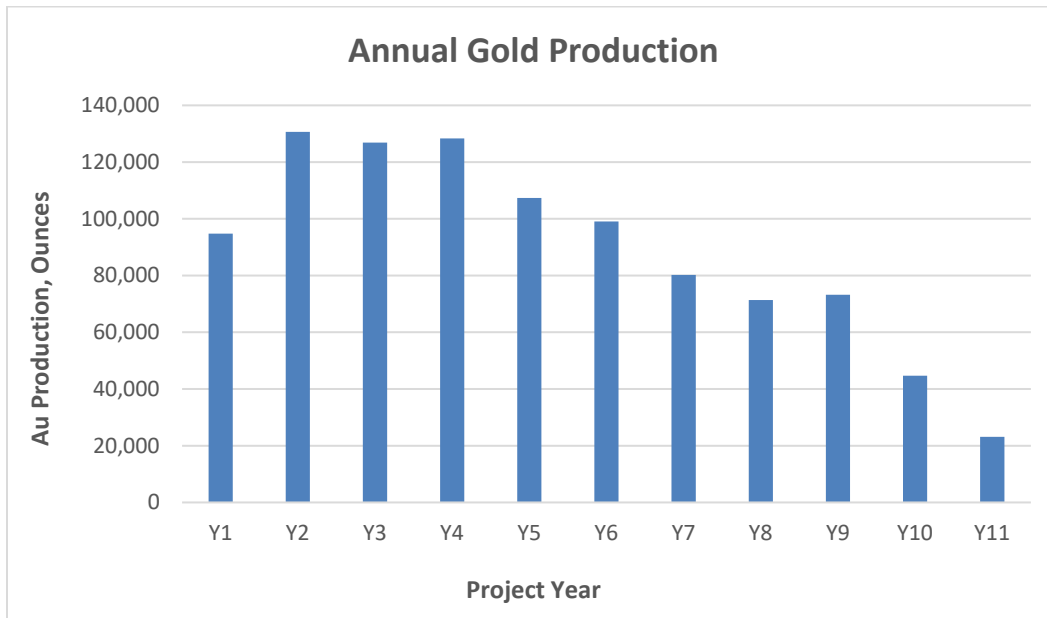

Figure 22.1 Annual Gold Production

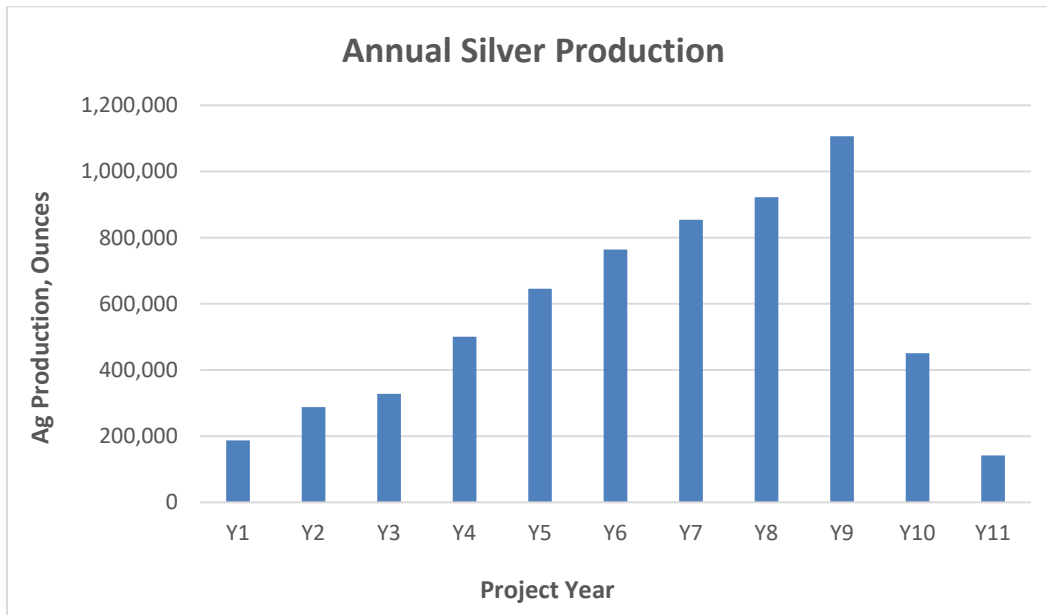

Figure 22.2 Annual Silver Production

22.5 Royalties

Under the terms of the acquisition agreement, Newmont acquired a 2% NSR royalty on all metal production from the Camino Rojo Project, except for metals produced under a sulphide joint venture option as stipulated in the acquisition agreement. On 29 October 2020 the 2% NSR royalty that pertains to the oxide material was acquired by Maverix Metals Inc.

A 0.5% royalty due to the Mexican government as an “Extraordinary Mining Duty” is also applicable. The 2% NSR royalty represents US\$33.5 million over the life of the mine and the 0.5% extraordinary mining duty represents US\$8.4 million.

22.6 Operating Costs

Operating costs were estimated by KCA for all process and support services. G&A operating costs were estimated by KCA with input from Orla. Mining costs were estimated by IMC. LOM operating costs for the Camino Rojo Project are summarized in Table 22-4. A detailed description of the operating cost build-up is included in Section 21.0 of this Technical Report.

Table 22-4
LOM Operating Costs

Description	LOM Cost (US\$/t Ore)
Mine	\$3.37
Process & Support Services	\$3.20
Site G & A	\$1.60
Total	\$8.17

22.7 Closure Costs

Reclamation and closure include costs for works to be conducted for the closure of the mine at the end of operations and have been estimated primarily by KCA with input from IMC for encapsulation of transition and sulphide material in the waste rock dump. The estimated LOM reclamation and closure costs is US\$28.6 million, not including G&A, or US\$0.42 per tonne ore processed based on a closure period of three years after the completion of operations. Reclamation and closure activities and costs are summarized in Section 20.0 of this Technical Report.

22.8 Taxation

22.8.1 Value Added Tax (IVA)

The “Impuesto al Valor Agregado” (IVA) is a 16% value added tax applied to all goods and services and is considered to be fully refundable. For the economic model, a 16% IVA is applied to all capital costs in the year in which they occur with the IVA refund or credit being applied in the following year. IVA is not considered in the operating cost estimate as it is assumed that once in operation IVA paid vs. IVA credits will be a net zero value during the period in which they occur.

22.8.2 Federal Income Tax

Federal income tax is applied at 30% of the Project income after deductions of eligible expenses including depreciation of assets, earthworks and indirect construction costs, exploration costs, special mining tax, extraordinary mining duty and any losses carried forward.

22.8.3 Special Mining Tax

The special mining duty is applied at 7.5% of the Project income after deduction of eligible exploration, earthworks and indirect costs expenses. Income subject to the special mining tax does not allow deductions for depreciation or allow losses carried forward.

22.8.4 Zacatecas Environmental “Green Tax”

A “Green Tax” was approved for the state of Zacatecas in 2017 which considers taxation of operations in order to increase tax revenue and reduce environmental impact for industrial activities. The tax is, as proposed, to be applied based on four categories:

- Environmental Remediation Tax on the Extraction of Materials
- Tax on Gas Emissions to the Atmosphere
- Tax on Emissions of Pollutants to the Soil, Subsoil and Water
- Tax on Disposal of Wastes

The environmental tax has been very controversial and is currently subject to several law suits by various existing operating companies. Further, although a proposed tax rate for each item has been proposed, it is unclear in the law how these taxes would be applied.

For the purposes of the Camino Rojo economic evaluation the “Green Tax” has not been included at this time as the extent to which this tax applies is unclear.

22.8.5 Depreciation

Depreciation of assets has been estimated based on a straight-line method with eligible cost items being depreciated at 10% or 12% per year based on the depreciation schedule for the specific item, including pooled costs for exploration and pre-production development of the Project. In addition to the base depreciation value, Mexican tax law allows for adjustments to the remaining depreciation pool balance for inflation. A 3% annual inflation adjustment for these tax pool balances is considered in the economic model.

All earthworks and indirect construction costs are assumed to be 100% depreciable in the year in which the expense occurred.

Salvage value is not considered for the depreciation value of capital items, as salvage is considered as taxable income in the model

A detailed list of items considered for the depreciation and tax pools is presented in Table 22-5.

**Table 22-5
Depreciation and Pre-Production Tax Pools**

Category	MXN Total	US\$ Total
Mine Concession acquisition costs	462,834,000	23,981,000
Layback Agreement	1,212,040,000	62,800,000
Royalty Acquisition Cost	207,266,000	10,739,000
Property & Equipment	7,343,000	380,000
Project exploration costs & expected 2020 spending	684,400,000	35,461,000
Operating tax loss carry fwd.	63,800,000	3,306,000
Subtotal	2,637,684,000	136,668,000
VAT	169,829,000	8,799,000
Total	2,807,513,000	145,467,000

*Note: Minor differences due to rounding

22.8.6 Loss Carry Forward

The Mexican tax law allows for the carry-forward of operating losses for the development of a property. The loss carry-forward is estimated at US\$3.3 million (MXN\$4,963.8 million) which is based on the 2018, 2019 and estimated 2020 tax return for MCR and are included in Table 22-5.

22.9 Economic Model & Cash Flow

The discounted cash flow model for the Camino Rojo Project is presented in Table 22-6 and is based on the inputs and assumptions detailed in this Section.

**Table 22-6
Cashflow Model Summary**

Item	UNITS	TOTAL	Year -1	Y1 Total	Y2 Total	Year 3	Year 4	Year 5	Year 6	Year 7	Year 8	Year 9	Year 10	Year 11	Year 12	Year 13	Year 14
Total Mined																	
Leachable Tonnes		67,363,000	168,000	7,438,000	9,248,000	7,756,000	7,569,000	7,355,000	7,995,000	7,120,000	6,571,000	6,311,000					
Au, g/t		0.73	0.65	0.72	0.74	0.78	0.82	0.80	0.68	0.63	0.67	0.74					
Ag, g/t		14.55	8.86	10.07	11.40	13.21	15.69	16.52	16.23	15.86	15.25	18.06					
Waste Mined		61,975,000	847,000	6,586,000	6,751,000	8,246,000	8,430,000	8,644,000	7,976,000	8,408,000	4,859,000	2,075,000					
Total mined		129,338,000	1,015,000	14,024,000	15,999,000	16,002,000	15,999,000	15,999,000	15,971,000	15,528,000	11,430,000	8,386,000					
Strip Ratio (W:O)		0.92	5.04			1.06	1.11	1.18	1.00	1.18	0.74	0.33					
Ore Processed																	
Kp Oxide		35,500,000	0	4,970,000	6,122,000	6,102,000	5,179,000	3,805,000	3,457,000	1,817,000	730,000	0	1,900,000	1,418,000			
Ki Oxide		8,892,000	66,000	847,000	447,000	393,000	265,000	245,000	753,000	552,000	63,000	102,000	4,229,000	996,000			
Transition Hi		10,472,000	0	0	0	36,000	955,000	1,774,000	949,000	2,112,000	2,086,000	2,403,000	157,000	0			
Transition Lo		12,499,000	0	0	0	40,000	172,000	746,000	1,412,000	2,088,000	3,692,000	4,065,000	284,000	0			
Total		67,363,000	66,000	5,817,000	6,569,000	6,571,000	6,571,000	6,570,000	6,571,000	6,569,000	6,571,000	6,570,000	6,570,000	2,414,000			
Au, g/t - Kp Oxide		0.791	0	0.86	0.91	0.87	0.92	0.87	0.71	0.51	0.71	0.00	0.28	0.31			
Ag, g/t - Kp Oxide		13.744	0	10.79	12.62	14.32	16.38	15.23	16.31	14.05	12.36	0.00	11.00	10.57			
Au, g/t - Ki Oxide		0.441	0.50	0.71	0.87	0.76	0.51	0.45	0.57	0.45	0.26	0.26	0.31	0.34			
Ag, g/t - Ki Oxide		7.972	6.81	8.79	8.50	9.22	9.20	8.85	9.98	6.64	9.17	7.68	7.58	6.94			
Au, g/t - Transition Hi		0.793	0	0	0.92	0.92	0.89	0.77	0.73	0.79	0.64	0.85	0.73	0.00			
Ag, g/t - transition Hi		20.461	0	0	7.06	21.56	21.53	22.73	20.45	19.38	20.32	7.73	7.73	0.00			
Au, g/t - Transition Lo		0.728	0	0	0.91	0.89	0.94	1.01	0.72	0.68	0.65	0.37	0.00	0.00			
Ag, g/t - Transition Lo		16.551	0	0	8.33	15.10	22.87	22.64	17.20	13.60	16.29	9.05	0.00	0.00			
contained Au, oz		1,588,271	1,065	156,875	192,000	182,544	190,858	182,729	161,718	139,575	141,057	151,779	64,189	24,948			
contained Ag, oz		31,505,958	14,451	1,963,583	2,603,913	2,944,779	3,551,330	3,709,406	3,775,747	3,481,919	3,222,788	3,724,116	1,824,249	704,128			
Ore Processed		Total	Year -1	Y1 Total	Y2 Total	Year 3	Year 4	Year 5	Year 6	Year 7	Year 8	Year 9	Year 10	Year 11	Year 12	Year 13	Year 14
Ore Processed																	
Ore Processed to Heap Leach		67,363,000	66,000	5,817,000	6,569,000	6,571,000	6,571,000	6,570,000	6,571,000	6,569,000	6,571,000	6,570,000	6,570,000	2,414,000			
Au grade		0.73	0.50	0.84	0.91	0.86	0.90	0.87	0.77	0.66	0.67	0.72	0.30	0.32			
Ag grade		14.55	6.81	10.50	12.33	13.94	16.81	17.56	17.87	16.49	15.25	17.63	8.64	9.07			
cont oz Au		1,588,271	1,065	156,875	192,000	182,544	190,858	182,729	161,718	139,575	141,057	151,779	64,189	24,948			
cont oz Ag		31,505,958	14,451	1,963,583	2,603,913	2,944,779	3,551,330	3,709,406	3,775,747	3,481,919	3,222,788	3,724,116	1,824,249	704,128			
Total Ore Processed, kt		67,363	66	5,817	6,569	6,571	6,571	6,570	6,571	6,569	6,571	6,570	6,570	2,414			
Au, g/t		0.73	0.50	0.84	0.91	0.86	0.90	0.87	0.77	0.66	0.67	0.72	0.30	0.32			
Ag, g/t		14.55	6.81	10.50	12.33	13.94	16.81	17.56	17.87	16.49	15.25	17.63	8.64	9.07			
contained Au, kg		49,400	33	4,879	5,972	5,678	5,936	5,683	5,030	4,341	4,387	4,721	1,996	776			
contained Ag, kg		979,930	449	61,073	80,990	91,591	110,457	115,374	117,437	108,298	100,238	115,831	56,740	21,901			
Recoverable Gold, kg		30,471	19	3,331	4,126	3,918	4,003	3,594	2,961	2,384	2,181	2,300	1,176	495			
Total Recoverable Gold, kg		30,471	19	3,331	4,126	3,918	4,003	3,594	2,961	2,384	2,181	2,300	1,176	495			
Total Recoverable Gold, koz		980	0.6	107.1	132.7	126.0	128.7	115.6	95.2	76.7	70.1	73.9	37.8	15.9			
Ultimate Recovery, Au		62%	56%	68%	69%	69%	67%	63%	59%	55%	50%	49%	59%	64%			
Recoverable Silver, kg		192,492	67	7,016	9,057	10,337	16,140	22,813	24,023	27,230	29,066	35,816	8,309	2,686			
Total Recoverable Silver, kg		192,492	67	7,016	9,057	10,337	16,140	22,813	24,023	27,230	29,066	35,816	8,309	2,686			
Total Recoverable Silver, koz		6,189	2.2	225.6	291.2	332.4	518.9	733.5	772.4	875.5	934.5	1,151.5	267.1	86.3			
Ultimate Recovery, Ag		20%	15%	11%	11%	11%	15%	20%	20%	25%	29%	31%	15%	12%			
Recoverable Gold Delayed, oz			597	12,321	14,363	13,455	13,817	22,037	18,156	14,619	13,374	14,100	7,212	0	0	0	0
Recoverable Silver Delayed, oz			2,168	38,152	41,667	46,161	64,545	152,355	160,433	181,854	194,117	239,193	55,491	0	0	0	0
Total Gold Produced, oz		979,681	0	94,779	130,630	126,885	128,327	107,338	99,089	80,196	71,376	73,212	44,707	23,142	0	0	0
Total Silver Produced, oz		6,188,844	0	187,412	287,687	327,863	500,522	645,654	764,277	854,058	922,251	1,106,444	450,844	141,834	0	0	0
Realized Recovery, Au			0%	60%	65%	66%	67%	65%	64%	64%	62%	61%	61%	62%	62%	62%	62%
Realized Recovery, Ag			0%	10%	10%	11%	12%	13%	15%	16%	18%	19%	20%	20%	20%	20%	20%
TOTAL EQUIVALENT Au oz PRODUCED		1,053,173	0	97,005	134,046	130,778	134,271	115,005	108,165	90,338	82,328	86,351	50,061	24,827	0	0	0

Item	UNITS	TOTAL	Year -1	Y1 Total	Y2 Total	Year 3	Year 4	Year 5	Year 6	Year 7	Year 8	Year 9	Year 10	Year 11	Year 12	Year 13	Year 14
Gold payable, oz		978,946	0	94,708	130,532	126,790	128,231	107,258	99,014	80,136	71,322	73,157	44,674	23,125	0	0	0
silver payable, oz		6,065,067	0	183,664	281,933	321,305	490,511	632,741	748,991	836,976	903,806	1,084,315	441,828	138,997	0	0	0
equivalent Au payable oz		1,050,969	0	96,889	133,880	130,605	134,056	114,772	107,909	90,075	82,055	86,033	49,920	24,776	0	0	0
Refining & Transportation Charge		8,798,167	\$0	\$357,585	\$528,106	\$571,074	\$780,284	\$925,059	\$1,055,856	\$1,137,143	\$1,206,627	\$1,430,229	\$603,603	\$202,600	\$0	\$0	\$0
NET REVENUE		\$1,672,752,026	\$0	\$154,664,958	\$213,679,524	\$208,397,193	\$213,708,550	\$182,709,474	\$171,598,044	\$142,982,805	\$130,081,397	\$136,222,915	\$79,268,742	\$39,438,426	\$0	\$0	\$0

OPERATING COSTS	Total	Year -1	Y1 Total	Y2 Total	Year 3	Year 4	Year 5	Year 6	Year 7	Year 8	Year 9	Year 10	Year 11	Year 12	Year 13	Year 14
Operating Costs																
Mining Cost \$3.37	\$226,669,501		\$19,607,588	\$24,266,704	\$24,593,799	\$24,587,395	\$24,739,531	\$27,287,282	\$29,255,401	\$21,679,787	\$16,638,521	\$10,848,211	\$3,165,283			
Processing Cost \$3.20	\$215,636,014		\$18,614,412	\$20,663,706	\$20,855,915	\$21,137,493	\$21,346,375	\$21,401,567	\$21,653,939	\$21,702,110	\$21,891,606	\$20,904,408	\$5,464,483			
G&A Cost \$1.60	\$108,004,600		\$9,463,806	\$9,236,264	\$9,517,002	\$9,270,892	\$9,574,537	\$9,308,343	\$9,636,764	\$9,348,846	\$9,704,086	\$9,392,695	\$5,992,252	\$2,869,360	\$2,344,877	\$2,344,877
TOTAL OPERATING COSTS	\$550,310,116	\$0	\$47,685,806	\$54,166,673	\$54,966,716	\$54,995,779	\$55,660,443	\$57,997,192	\$60,546,104	\$52,730,743	\$48,234,212	\$41,145,314	\$14,622,019	\$2,869,360	\$2,344,877	\$2,344,877

OPERATING CASH FLOW	Total	Year -1	Y1 Total	Y2 Total	Year 3	Year 4	Year 5	Year 6	Year 7	Year 8	Year 9	Year 10	Year 11	Year 12	Year 13	Year 14
	\$1,122,441,910	\$0	\$106,979,152	\$159,512,851	\$153,430,477	\$158,712,771	\$127,049,031	\$113,600,851	\$82,436,701	\$77,350,653	\$87,988,703	\$38,123,427	\$24,816,407	(\$2,869,360)	(\$2,344,877)	(\$2,344,877)

TAXES	Total	Year -1	Y1 Total	Y2 Total	Year 3	Year 4	Year 5	Year 6	Year 7	Year 8	Year 9	Year 10	Year 11	Year 12	Year 13	Year 14
Taxes																
Zacatecas Green Tax	\$0		\$0	\$0												
Income Tax Payable	\$202,131,779		\$9,676,954	\$34,218,086	\$32,515,940	\$33,718,566	\$24,304,215	\$20,735,477	\$12,010,074	\$13,029,101	\$17,113,822	\$4,809,545	\$0	\$0	\$0	\$0
TOTAL TAXES	\$283,682,271	\$0	\$17,481,892	\$45,790,333	\$43,734,246	\$45,337,513	\$33,513,915	\$29,053,195	\$18,039,870	\$18,701,707	\$23,588,337	\$7,530,034	\$911,229	\$0	\$0	\$0

CASH FLOW BEFORE CAPITAL	Total	Year -1	Y1 Total	Y2 Total	Year 3	Year 4	Year 5	Year 6	Year 7	Year 8	Year 9	Year 10	Year 11	Year 12	Year 13	Year 14
	\$838,759,640	\$0	\$89,497,260	\$113,722,518	\$109,696,231	\$113,375,257	\$93,535,116	\$84,547,657	\$64,396,831	\$58,648,946	\$64,400,365	\$30,593,393	\$23,905,178	(\$2,869,360)	(\$2,344,877)	(\$2,344,877)

CAPITAL COSTS	Total	Year -1	Y1 Total	Y2 Total	Year 3	Year 4	Year 5	Year 6	Year 7	Year 8	Year 9	Year 10	Year 11	Year 12	Year 13
Capital Costs															
Mine Equipment	\$0	\$0	\$0	\$0	\$0	\$0	\$0	\$0	\$0	\$0	\$0	\$0	\$0	\$0	\$0
Mining Contractor Option Costs	\$0	\$0	\$0	\$0	\$0	\$0	\$0	\$0	\$0	\$0	\$0	\$0	\$0	\$0	\$0
Earthworks	\$0	\$0	\$0	\$0	\$0	\$0	\$0	\$0	\$0	\$0	\$0	\$0	\$0	\$0	\$0
Haul Roads	\$0	\$0	\$0	\$0	\$0	\$0	\$0	\$0	\$0	\$0	\$0	\$0	\$0	\$0	\$0
Pits	\$0	\$0	\$0	\$0	\$0	\$0	\$0	\$0	\$0	\$0	\$0	\$0	\$0	\$0	\$0
WRD	\$0	\$0	\$0	\$0	\$0	\$0	\$0	\$0	\$0	\$0	\$0	\$0	\$0	\$0	\$0
Contractor Mobilization	\$448,000	\$400,000	\$0	\$0	\$0	\$48,000	\$0	\$0	\$0	\$0	\$0	\$0	\$0	\$0	\$0
Contractor Demobilization	\$716,000	\$0	\$0	\$0	\$0	\$0	\$0	\$0	\$0	\$0	\$0	\$0	\$716,000	\$0	\$0
Pre-Production Stripping	\$1,686,482	\$1,686,482	\$0	\$0	\$0	\$0	\$0	\$0	\$0	\$0	\$0	\$0	\$0	\$0	\$0
Owner Equipment, Supplies & Licenses	\$785,730	\$490,050	\$0	\$0	\$0	\$0	\$295,680	\$0	\$0	\$0	\$0	\$0	\$0	\$0	\$0
Mine Contingency	\$0	\$0	\$0	\$0	\$0	\$0	\$0	\$0	\$0	\$0	\$0	\$0	\$0	\$0	\$0
Mine Subtotal	\$3,636,212	\$2,576,532	\$0	\$0	\$0	\$48,000	\$295,680	\$0	\$0	\$0	\$0	\$0	\$716,000	\$0	\$0
Major Earthworks	\$18,975,796	\$16,855,903	\$0	\$1,059,947	\$0	\$0	\$1,059,947	\$0	\$0	\$0	\$0	\$0	\$0	\$0	\$0
Liner / Materials (Supply & Install)	\$12,402,270	\$3,032,595	\$0	\$4,684,838	\$0	\$0	\$4,684,838	\$0	\$0	\$0	\$0	\$0	\$0	\$0	\$0
Civils (Supply & Install)	\$4,598,549	\$4,598,549	\$0	\$0	\$0	\$0	\$0	\$0	\$0	\$0	\$0	\$0	\$0	\$0	\$0
Structural Steel (Supply & Install)	\$0	\$0	\$0	\$0	\$0	\$0	\$0	\$0	\$0	\$0	\$0	\$0	\$0	\$0	\$0
Platwork (Supply)	\$120,089	\$120,089	\$0	\$0	\$0	\$0	\$0	\$0	\$0	\$0	\$0	\$0	\$0	\$0	\$0
Platwork (Install)	\$47,381	\$47,381	\$0	\$0	\$0	\$0	\$0	\$0	\$0	\$0	\$0	\$0	\$0	\$0	\$0
Mechanical Equipment (Supply)	\$41,794,575	\$34,215,737	\$0	\$1,417,047	\$3,840,500	\$238,323	\$1,417,047	\$0	\$238,323	\$427,600	\$0	\$0	\$0	\$0	\$0
Mechanical Equipment (Install)	\$5,139,207	\$4,789,347	\$0	\$174,930	\$0	\$0	\$174,930	\$0	\$0	\$0	\$0	\$0	\$0	\$0	\$0
Piping (Supply & Install)	\$6,588,555	\$6,092,404	\$0	\$248,076	\$0	\$0	\$248,076	\$0	\$0	\$0	\$0	\$0	\$0	\$0	\$0
Electrical (Supply)	\$4,934,128	\$4,934,128	\$0	\$0	\$0	\$0	\$0	\$0	\$0	\$0	\$0	\$0	\$0	\$0	\$0
Electrical (Install)	\$602,282	\$602,282	\$0	\$0	\$0	\$0	\$0	\$0	\$0	\$0	\$0	\$0	\$0	\$0	\$0
Instrumentation (Supply & Install)	\$180,381	\$180,381	\$0	\$0	\$0	\$0	\$0	\$0	\$0	\$0	\$0	\$0	\$0	\$0	\$0

Item	UNITS	TOTAL	Year -1	Y1 Total	Y2 Total	Year 3	Year 4	Year 5	Year 6	Year 7	Year 8	Year 9	Year 10	Year 11	Year 12	Year 13	Year 14
Infrastructure (Supply & Install)		\$14,576,959	\$14,576,959	\$0	\$0												
Spare Parts		\$1,449,111	\$1,449,111	\$0	\$0												
Freight & Duties	incl			\$0	\$0												
Process Contingency		\$14,385,871	\$11,795,144	\$0	\$1,058,127	\$384,050	\$23,832	\$1,058,127		\$23,832	\$42,760						
EPCM		\$8,020,431	\$8,020,431	\$0	\$0												
Commissioning & Supervision		\$57,380	\$57,380	\$0	\$0												
Supplier Engineering		\$0	\$0	\$0	\$0												
Indirect Costs (incl. contingency)		\$2,617,198	\$2,617,198	\$0	\$0												
Owner's Costs (incl. contingency)		\$17,494,879	\$17,494,879	\$0	\$0												
Subtotal		\$157,621,257	\$134,056,430	\$0	\$8,642,963	\$4,224,549	\$310,155	\$8,938,643	\$0	\$262,155	\$470,360	\$0	\$0	\$716,000	\$0	\$0	\$0
Working Capital (Initial Fills)		\$805,784	\$805,784														
Working Capital (60 days)		\$8,826,433	\$8,826,433														
Process Preproduction		\$213,048	\$213,048														
Less: Working Capital Recovery		\$9,845,265											\$6,563,510	\$3,281,755			
Net Working Capital		\$0	\$9,845,265	\$0	\$0	\$0	\$0	\$0	\$0	\$0	\$0	\$0	(\$6,563,510)	(\$3,281,755)			
Subtotal		\$157,621,257	\$143,901,695	\$0	\$8,642,963	\$4,224,549	\$310,155	\$8,938,643	\$0	\$262,155	\$470,360	\$0	(\$6,563,510)	(\$2,565,755)	\$0	\$0	\$0
IVA	16%	\$25,219,401	\$21,449,029	\$0	\$1,382,874	\$675,928	\$49,625	\$1,430,183	\$0	\$41,945	\$75,258	\$0	\$0	\$114,560	\$0	\$0	\$0
Less: IVA (Rebate)		\$25,219,401	\$0	\$21,449,029	\$0	\$1,382,874	\$675,928	\$49,625	\$1,430,183	\$0	\$41,945	\$75,258	\$0	\$0	\$114,560	\$0	\$0
Net IVA		\$0	\$21,449,029	(\$21,449,029)	\$1,382,874	(\$706,946)	(\$626,303)	\$1,380,558	(\$1,430,183)	\$41,945	\$33,313	(\$75,258)	\$0	\$114,560	(\$114,560)	\$0	\$0
Subtotal		\$157,621,257	\$165,350,724	(\$21,449,029)	\$10,025,838	\$3,517,603	(\$316,148)	\$10,319,201	(\$1,430,183)	\$304,100	\$503,673	(\$75,258)	(\$6,563,510)	(\$2,451,195)	(\$114,560)	\$0	\$0
Reclamation & Closure	\$0.42	\$28,581,037										\$697,858	\$12,014,130	\$5,414,150	\$5,663,111	\$4,791,788	
TOTAL CAPITAL		\$186,202,293	\$165,350,724	(\$21,449,029)	\$10,025,838	\$3,517,603	(\$316,148)	\$10,319,201	(\$1,430,183)	\$304,100	\$503,673	(\$75,258)	(\$6,563,510)	\$9,562,935	\$5,299,590	\$5,663,111	\$4,791,788

PRE-TAX NET CASH FLOW		Total	Year -1	Y1 Total	Y2 Total	Year 3	Year 4	Year 5	Year 6	Year 7	Year 8	Year 9	Year 10	Year 11	Year 12	Year 13	Year 14
Pre-Tax Net Cash Flow																	
Pre-tax net cash flow		\$936,239,617	(165,350,724)	128,428,181	149,487,013	149,912,874	159,028,918	116,729,829	115,031,034	82,132,601	76,846,981	88,063,960	43,989,080	15,253,472	(8,168,950)	(8,007,988)	(7,136,665)
Royalty Payable	2.00%	\$33,455,041	0	3,093,299	4,273,590	4,167,944	4,274,171	3,654,189	3,431,961	2,859,656	2,601,628	2,724,458	1,585,375	788,769	0	0	0
Extraordinary Mining Duty	0.50%	\$8,363,760	0	773,325	1,068,398	1,041,986	1,068,543	913,547	857,990	714,914	650,407	681,115	396,344	197,192	0	0	0
Salvage Value		\$4,426,164		0	0									0	\$1,253,837	\$2,507,675	664,652
IVA Refund (Project Purchase + Pre-Prod. Exploration)		\$8,799,434		8,799,434	0												
Pre-tax net cash flow		\$907,646,415	(165,350,724)	133,360,991	144,145,025	144,702,944	153,686,205	112,162,093	110,741,083	78,558,031	73,594,946	84,658,387	42,007,361	14,267,511	(6,915,112)	(5,500,313)	(6,472,013)
Cumulative			(165,350,724)	(31,989,733)	112,155,293	256,858,236	410,544,441	522,706,534	633,447,617	712,005,648	785,600,594	870,258,981	912,266,342	926,533,854	919,618,741	921,033,540	913,146,728
AFTER-TAX NET CASH FLOW																	
After-Tax Net Cash Flow																	
Income & Other																	
Taxes		\$283,682,271	\$0	\$17,481,892	\$45,790,333	\$43,734,246	\$45,337,513	\$33,513,915	\$29,053,195	\$18,039,870	\$18,701,707	\$23,588,337	\$7,530,034	\$911,229	\$0	\$0	\$0
After-Tax net annual Cash Flow, \$		\$623,964,144	(165,350,724)	\$115,879,099	\$98,354,693	\$100,968,698	\$108,348,691	\$78,648,178	\$81,687,889	\$60,518,161	\$54,893,239	\$61,070,050	\$34,477,327	\$13,356,282	(\$6,915,112)	(\$5,500,313)	(\$6,472,013)
Cumulative			(165,350,724)	(\$49,471,624)	\$48,883,068	\$149,851,766	\$258,200,458	\$336,848,636	\$418,536,525	\$479,054,685	\$533,947,924	\$595,017,974	\$629,495,301	\$642,851,583	\$635,936,471	\$637,351,270	\$629,464,458

The Camino Rojo cash flows are net of royalties and taxes. The Project yields an after-tax internal rate of return of 61.8%.

22.10 Sensitivity

To estimate the relative economic strength of the Project, base case sensitivity analyses have been completed analyzing the economic sensitivity to several parameters including changes in gold price, capital costs, average operating cash cost per tonne of ore processed and exchange rate. The sensitivities are based on +/- 25% of the base case for capital costs, operating costs and exchange rate and select gold prices ranging from US\$1,250 to US\$1,950 per oz. The after-tax analysis is presented in Table 22-7. Figure 22.3 and Figure 22.4 present graphical representations of the after-tax sensitivities. Variation in gold price has the largest influence on the sensitivity of the Project. From these sensitivities it can be seen that the Project is economically robust.

The economic indicators chosen for sensitivity evaluation are the internal rate of return (IRR) and NPV at 5% discount rate.

**Table 22-7
After-Tax Sensitivity Analysis Results**

	Variation	IRR	NPV	
			5%	10%
Gold Price				
	\$1,250	44.4%	\$287,625,123	\$201,282,921
	\$1,425	53.3%	\$369,731,522	\$264,885,795
100%	\$1,600	61.8%	\$451,837,920	\$328,488,669
	\$1,775	70.0%	\$533,944,319	\$392,091,544
	\$1,950	78.1%	\$616,050,718	\$455,694,418
Capital Costs				
75%	\$149,258,295	80.3%	\$477,297,593	\$354,437,261
90%	\$171,424,694	68.1%	\$462,021,789	\$338,868,106
100%	\$186,202,293	61.8%	\$451,837,920	\$328,488,669
110%	\$200,979,892	56.5%	\$441,654,051	\$318,109,233
125%	\$223,146,291	49.9%	\$426,378,248	\$302,540,078
Operating Costs				
75%	\$412,732,587	67.5%	\$517,769,533	\$378,081,236
90%	\$495,279,104	64.1%	\$478,210,566	\$348,325,696
100%	\$550,310,116	61.8%	\$451,837,920	\$328,488,669
110%	\$605,341,128	59.5%	\$425,465,275	\$308,651,643
125%	\$687,887,645	55.9%	\$385,906,308	\$278,896,103
Exchange Rate				
75%	14.475	58.9%	\$441,864,790	\$320,238,383
90%	17.37	60.8%	\$448,512,634	\$325,737,640
100%	19.30	61.8%	\$451,837,920	\$328,488,669
110%	21.23	62.7%	\$454,557,049	\$330,737,925
125%	24.125	63.7%	\$457,821,959	\$333,439,033

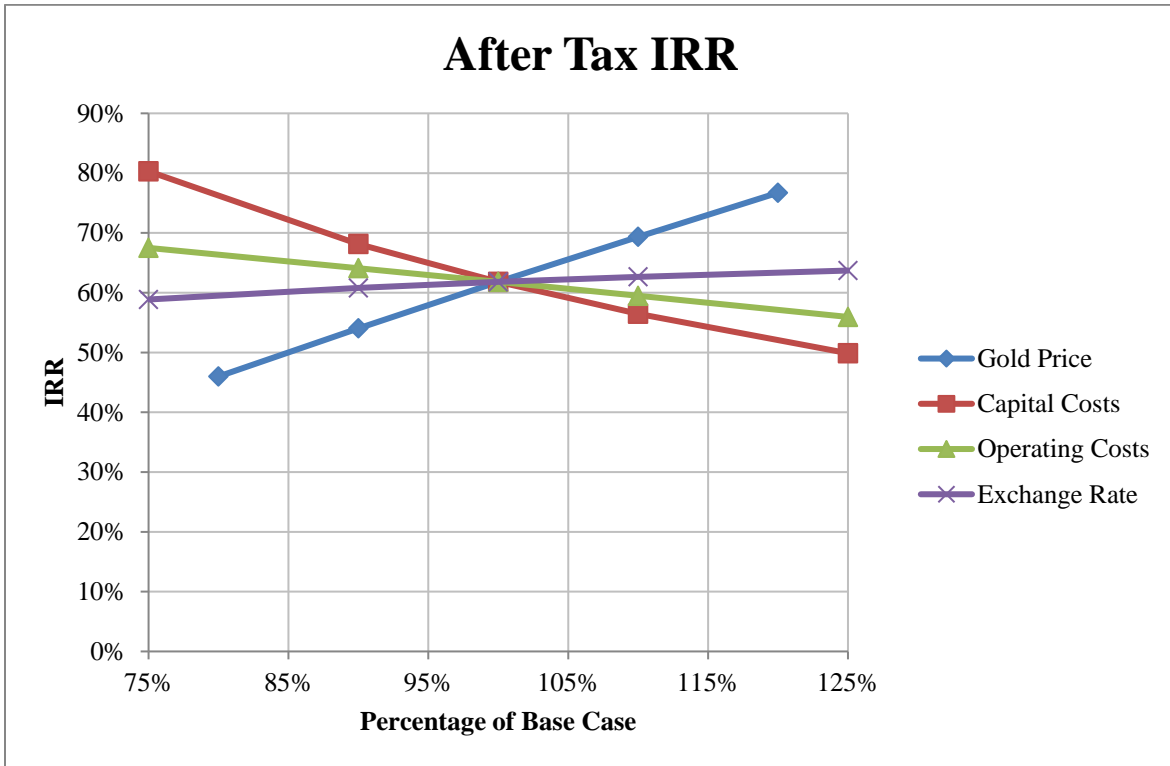

Figure 22.3 After Tax Sensitivity – IRR

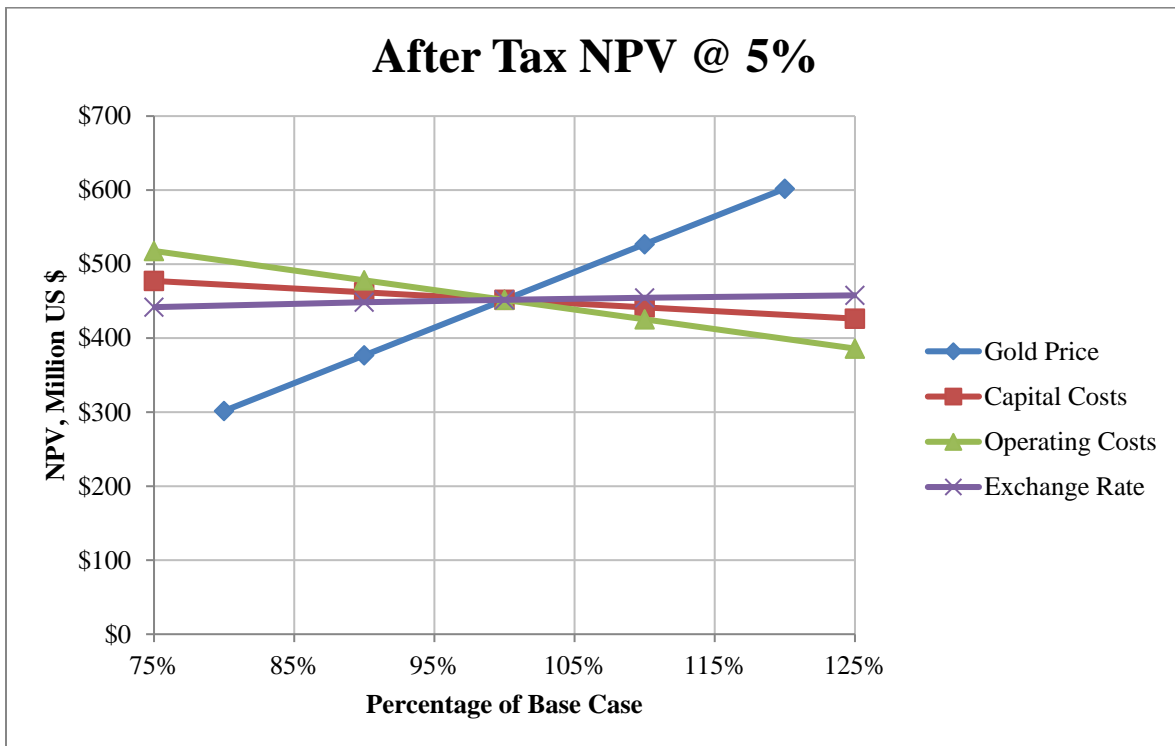

Figure 22.4 After Tax Sensitivity – NPV @ 5%

23.0 ADJACENT PROPERTIES

There are no active exploration properties or producing mines immediately adjacent to the Camino Rojo Project. The Layback Agreement provides Orla with the right to mine from Fresnillo's mineral concession, and recover for Orla's account, all oxide and transitional material amenable to heap leaching that is within an expanded open pit. Results from holes drilled on Fresnillo's concession in close proximity to the most northern holes on the Orla property appear to be consistent with projections of the geological and oxidation models created from Orla's data and assay results. Additional work is required to bring material on Fresnillo's concession to the measured and indicated Mineral Resource categories. Therefore, in this Feasibility Study, all material to be mined on the Fresnillo mineral concession is classified as waste.

24.0 OTHER RELEVANT DATA AND INFORMATION

24.1 Current Project Status

Orla is currently constructing the project outlined in the 2019 Technical Report. The start of earthworks was announced on 26 November 2020. As of the date of this Technical Report, Orla has completed over 90% of the detailed engineering for the project and procurement is 85% complete. Current activities include flora and fauna relocation, site clearing and topsoil removal. The 44-kilometre powerline construction is 49% complete. Equipment deliveries to site commenced in December 2020. A total of US\$78 million of the total Project capital has been committed through purchase orders and contracts. The mining contract is being finalized and expected to be in place early in the first quarter of 2021.

24.2 Project Implementation

24.2.1 Project Development

Orla hired an EPCM Management Company (PMC) for the development of the Project to act on behalf of the owner to complete the detail engineering and project implementation. The PMC will manage and supervise the engineering consultants.

The PMC will also execute the following responsibilities:

- Procurement tasks for all equipment and supplies
- Logistics tasks
- Project controls
- Process all accounts payable documentation
- Scheduling
- Contracts management
- Project safety
- Client reporting

24.2.2 Project Controls

Standard project controls will be used during the implementation of the Camino Rojo Project. Multiple software packages are normally used to control various aspects of the following:

- Document control
- Tech specifications and manuals
- Project budget

- Contracts
- Purchasing
- Expediting and logistics
- Bidding process and tracking
- Change orders
- Receiving / warehousing and materials management
- Construction job cost system and interface with the accounting system
- Tracking and forecasting costs estimates to completion (“ETC”)
- Scheduling
- Safety statistics

A project server will be dedicated to storage and there will be controlled access to all project relevant documents.

Weekly progress reports and monthly cost reports of project status will be prepared and distributed.

24.2.3 Procurement and Logistics

The PMC will purchase all material for the Project on behalf of the Owner. This enables direct control over the procurement budget and schedule. The team performs equipment technical reviews and negotiations, analyses the total delivery cost, issues recommendations and produces the purchase orders or contractual documents upon owner’s approval. The team coordinates logistics and assists suppliers. Freight forwarding is managed dynamically to minimize the freight transit times and avoid transportation issues. A weekly expediting report is also generated showing the status of purchase orders and latest estimate of delivery dates for each purchase with latest status of customs clearances, etc.

24.2.4 Construction

The PMC will provide the site construction management team and supplement the site staff with resources as required. Personnel that are planned to be kept after the preproduction period and become operations key personnel will be directly hired by the owner. Lump sum contracts will be considered when practical and cost reimbursable contracts will be awarded when preferable. Early in the Project, mobile equipment will be purchased by the owner for use during the construction phase that will be turned over to the operations group shortly after commissioning. This equipment includes:

- 50 t all-terrain crane
- 10 t boom truck
- Forklift

- Telehandler
- Backhoe / loader
- D6 dozer
- Maintenance truck

This equipment will be purchased new over the course of the Project as the need for each arises.

For this Technical Report, quotations were received that considered all contractors bringing their own cranes. In practice, it is usually more efficient and less expensive if the owner purchases one crane and rents sufficient additional cranes for each phase of the Project. The owner can then globally manage and allocate cranes to each contractor's activities on an as-needed basis.

The owner will contract one concrete batch plant for the site. All concrete requirements for the Project will be supplied at the owner's cost and delivered to the various contractors excepting any contractors who decide to make their own arrangements for concrete supply.

The owner will provide sanitary services, domestic water and general services supply throughout the Project site at no cost to the contractors.

24.2.5 Construction Schedule

Project construction on site began in the fourth quarter of 2020. Project delays attributed to the ongoing COVID-19 pandemic have affected and are expected to continue to affect the construction timeline. Assuming commissioning and initial production are able to begin during the 4th quarter of 2021, the first gold pour is expected late in the 4th quarter of 2021.

A proposed project development and implementation schedule is presented in Figure 24.1.

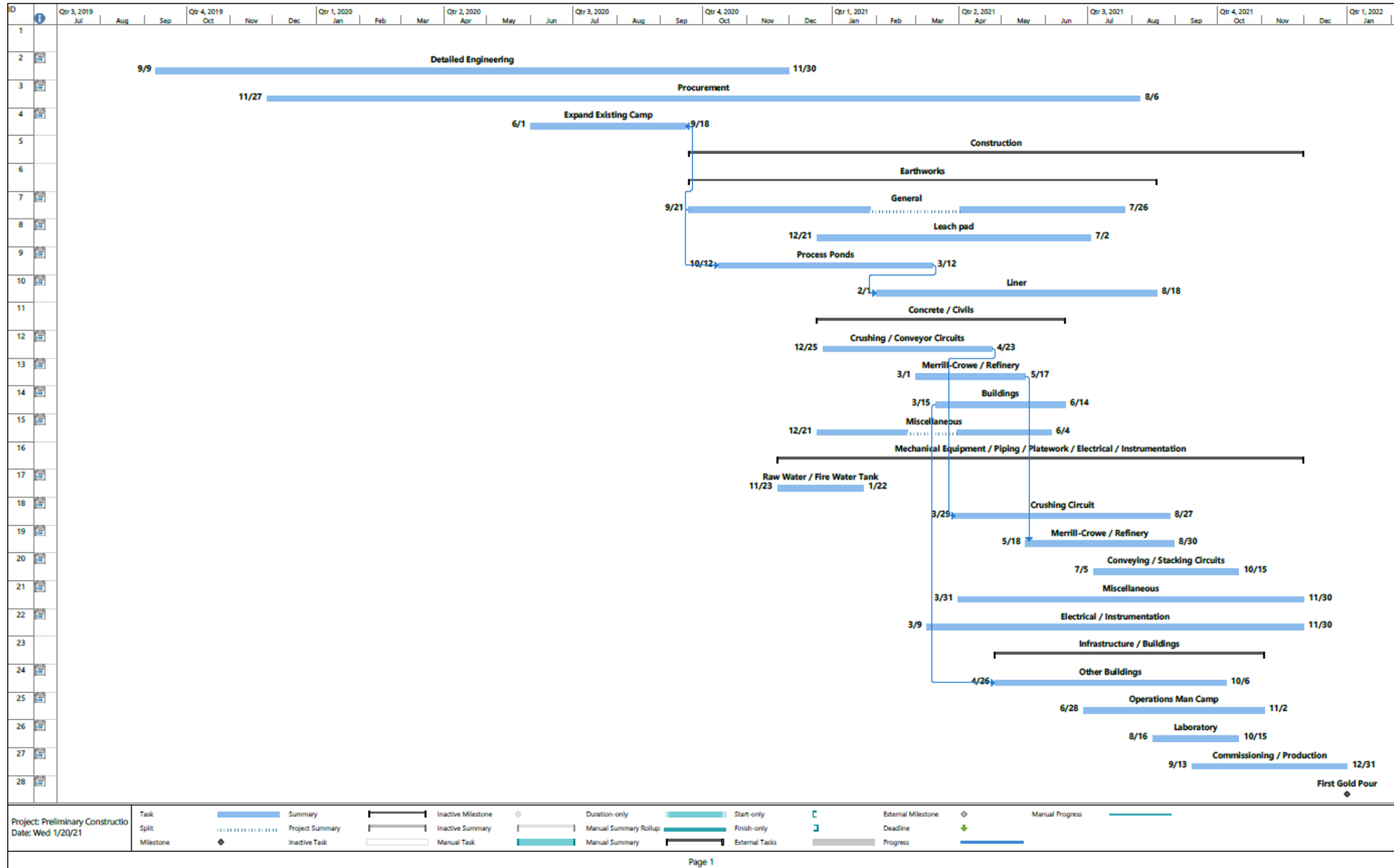

Figure 24.1 Project Development & Implementation Schedule

24.3 Site Geotechnical Analyses

Piteau conducted a number of geotechnical studies for the Project including slope stability assessments for the heap, waste dumps and pit slopes. The foundation conditions in the vicinity of the heap leach pad and the waste rock dump are based on the results of site investigation programs carried out by Piteau across the Project site in 2014, 2018 and 2019. These investigations included 74 test pits and 19 drillholes. The pit slope design is based on the results of site investigation programs carried out by Piteau in 2014, 2015 and 2018. These investigations included an additional 21 drillholes.

24.3.1 Heap Leach Pad Stability

The geometry of the heap leach pad is proposed to be developed in eight lifts; each superior lift with a height of 10 metres above the underlying lift and with each lift sloping at an angle similar to the foundation. The repose angle slope of each lift of the heap material was assumed to be 39°, the assumed angle of internal friction of the ore. To allow pregnant solution to be collected, an LLDPE liner will be installed at the base of the HLP. To form a foundation for the liner and help minimize seepage into the foundation in the event of a leak in the LLDPE liner, a 30cm layer of low permeability material will be placed and compacted across the entire footprint of the HLP.

The details of the heap stability design can be seen in the report “Feasibility Geotechnical Assessment of the Waste Dump, Heap Leach Pad and Site Infrastructure” and is referenced in Section 27 of this Technical Report.

The results of the heap stability analyses indicate a stable facility at the design heights and slope angles.

24.4 Hydrogeology

Hydrogeological and groundwater investigations have been carried out at the Project site and are detailed in the following technical documents and reports:

- Barranca Group LLC, 2018, Groundwater Conditions – Camino Rojo Project.
- Barranca Group LLC, 2019a, Technical Memo – Camino Rojo Project - Pump Test Summary, Well CR-01. January 2019.
- D.B. Stephens & Assoc, 2019, Laboratory Report for Orla Mining Ltd., Project: Camino Rojo. Daniel B. Stephens & Associates, Inc. Feb 4, 2019.
- Barranca Group LLC, 2019b, Camino Rojo Project - Production Well PW-1. April 2019.

- Barranca Group LLC, 2019c, Camino Rojo Project - Heap Leach Area Monitor Wells. June 2019.
- Barranca Group LLC, 2019d, Camino Rojo Project - Well Summary Report PW-2. June 2019
- KCA, 2019, Feasibility Study: NI 43-101 Technical Report on the Camino Rojo Gold Project, Municipality of Mazapil, Zacatecas, Mexico. Prepared for: Orla Mining. Prepared by Kappes, Cassidy & Assoc. June 25, 2019.
- Ward, J.J., 2019, Groundwater Flow Modeling: Camino Rojo Mine Project, San Tiburcio, State of Zacatecas, Mexico. Prepared for Orla Mining, Ltd. by John J. Ward, CPG, Groundwater Consultant, LLC. July 2019 (v.2).
- Ward, J.J., 2020, Groundwater Flow Modeling for Unconstrained Mine Pit: Camino Rojo Mine Project, San Tiburcio, State of Zacatecas, Mexico. Prepared for Orla Mining, Ltd. by John J. Ward, CPG, Groundwater Consultant, LLC. February 2020.

The scope of work for the hydrogeological investigations was primarily focused on locating suitable water sources for mine and process operations, and constructing a groundwater model to simulate mine pit dewatering rates and off-site impacts from mine dewatering. Results and conclusions are based on information in the above studies and are referenced in Section 27 of this Technical Report.

24.4.1 Occurrence and Movement of Groundwater

Regional groundwater flow occurs primarily with Cretaceous and Jurassic formations described in Section 7.2 of this Technical Report. These formations have very low primary permeability; groundwater flow appears to be mostly controlled by secondary processes (fracturing, and solution cavities in limestone units). This has been verified by downhole logging, core testing (DB Stephens & Assoc., 2019), and analysis of flow responses to pumping wells (Montgomery & Assoc 2015; Barranca, 2019b; 2019d).

Groundwater flows have been defined in both the Guadalupe Garzarón (Salazar et al, 2014a) and El Cardito (Salazar et al, 2014b) Basins. The Project site is near the surface water divide between these basins. Figure 24.2 is a contour map of regional groundwater levels, developed from published data and supplemented by Project site production and monitoring wells and piezometers. Groundwater flows from higher recharge areas in the mountains north and south of the Project site, and also from ponded water in tanks in the San Tiburcio and El Berrendo areas, as evidenced by very shallow water levels and groundwater mounding in those areas. Groundwater flows beneath the Project site area in the Guadalupe Garzarón Basin toward the east or east-northeast into a groundwater sink located east of La Pardita (Salazar et al, 2014a).

West of the Project site in the El Cardito Basin groundwater flows in a westerly direction. There are no apparent surface expressions of groundwater discharge (spring flow, base flow) in either Basin defined within Figure 24.2.

Groundwater levels within the Project site area are shown in Figure 24.3. At the Project site groundwater has a more northerly component. Information from the coring and packer testing program conducted by Piteau indicates that there is a vertical downward groundwater head gradient in the vicinity of the proposed pit (Piteau, 2014). Water level elevations in the immediate vicinity of the proposed mine pit are low relative to wells further to the south. As depicted, groundwater flows from the village of San Tiburcio area north towards the pit area.

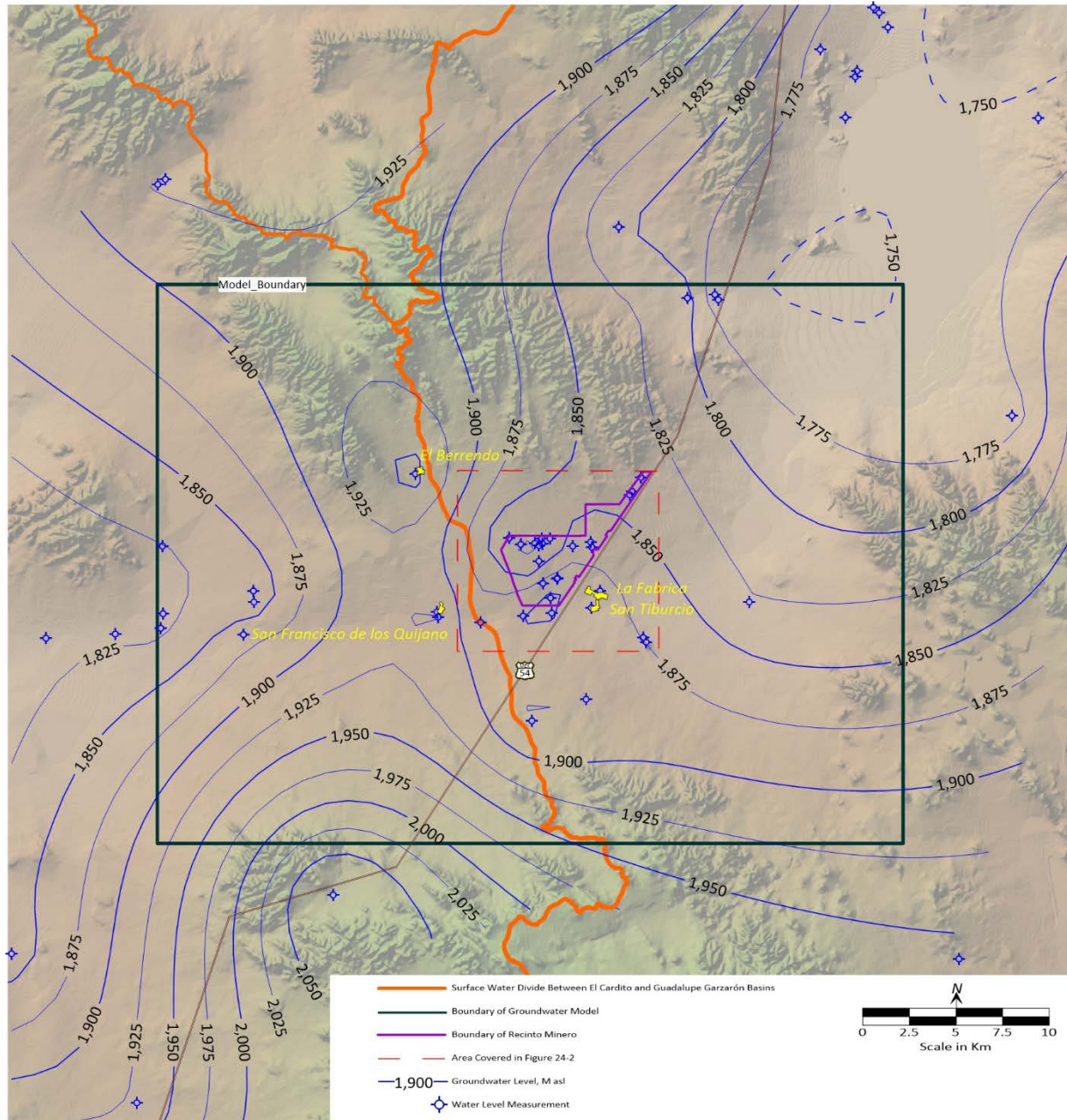

Figure 24.2 Regional Groundwater Elevation Contours, Camino Rojo Project, Zacatecas

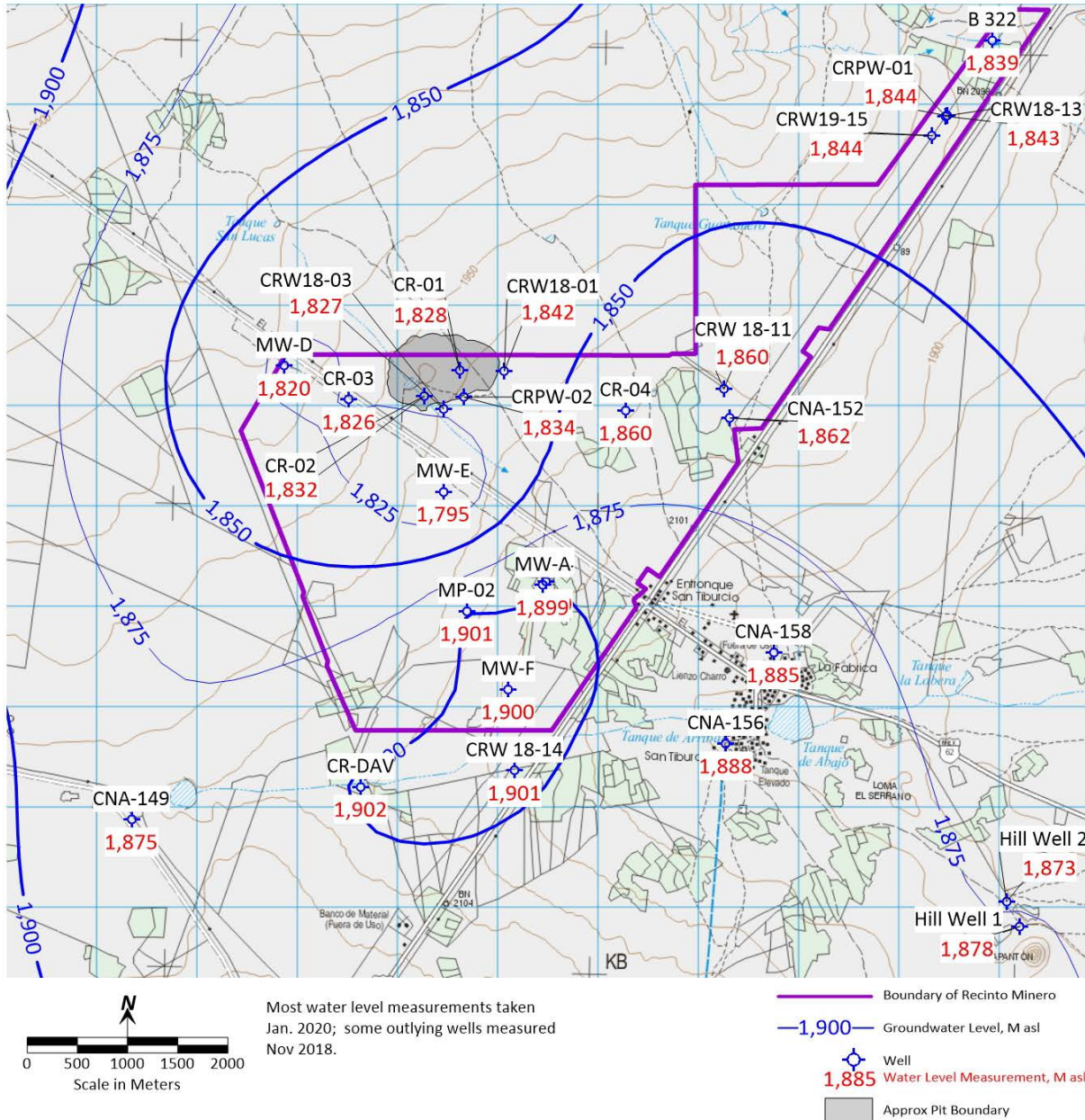

Figure 24.3 Project Area Groundwater Elevation Contours, Camino Rojo Project, Zacatecas

Monitor well construction in the vicinity of the proposed heap leach pad encountered water at depths as shallow as 20 metres (Barranca, 2019c). Although these shallow depths could be indicative of a “perched zone,” water quality from shallow wells is similar to wells completed deeper in the Caracol Formation (Figure 24.3 and Table 24-1).

The water level contours, as currently shown in Figure 24.3, are indicative of groundwater flow toward the proposed pit area from the south. One explanation for this phenomenon could be that vertical fracturing in the pit area, in combination with a downward gradient, is transmitting water downward along vertical fractures that could be related to either the mineralizing system or possibly the San Tiburcio Fault. Because of the extremely low primary permeability of the Caracol Formation (D.B. Stephens & Assoc, 2019), the potential rate of vertical groundwater movement is expected to be very small.

24.4.2 Groundwater Quality and Use

Water quality analytical results for samples collected from wells on or near the Project are summarized in Table 24-1. The water quality in wells completed in the Caracol Formation in the Project area is poor, with concentrations of total dissolved solids (TDS) generally exceeding 4,000 milligrams/liter (mg/l) and sulfate concentrations generally above 1,500 mg/l. TDS concentrations in samples from well CR-04 have exceeded 12,000 mg/l. The constituent concentrations in Table 24-1 that exceed the Mexican Regulatory potable water limit (NOM-127-SSA1-2002) are colored orange.

The water samples collected from PW-1, which derives groundwater from the Cuesta del Cura Formation, had TDS concentrations just over 1,000 mg/l and sulfate concentrations between 300 and 350 mg/l. The Mexican regulatory limit for potable water for these constituents is 1,000 mg/l and 400 mg/l, respectively. This indicates water quality in the Cuesta del Cura is distinctive from the water quality in the Caracol. Water samples from the monitor wells near the proposed heap leach facility (MP-1 and MP-2) also have extremely elevated TDS, chloride and sulfate concentrations.

The communities within the “Core Area of Influence” of the Camino Rojo mine are listed in Table 20-4. These are San Tiburcio (including La Fábrica), El Berrendo, and San Francisco de los Quijano. The total population in these communities is 1,209. Water quality results from groundwater wells serving these communities are summarized in Table 24-2. The highest water quality of those wells is from CNA-139, serving the community of El Berrendo. CNA-139 is a relatively shallow well constructed near a surface impoundment. Water is treated by reverse-osmosis at El Berrendo for potable use.

Water quality in wells serving San Tiburcio, La Fábrica, and San Francisco de los Quijano exceeds regulatory limits for TDS, sulfate and hardness, among other constituents, and is considered non-potable. Because groundwater quality is poor and generally non-potable due to elevated naturally-occurring total dissolved solids, mostly exceeding 2,000 mg/l (Aguayo Hurtado, 2019a), the residents of these communities make extensive use of small impoundments to collect water from precipitation events and runoff, which are an important source of stock and limited agricultural water.

Water supply and use at these communities:

San Tiburcio. There are 979 residents in San Tiburcio and La Fábrica. Water supply is from the Pozo San Tiburcio well, approximately 5 km south of the community and 9.3 km from the Camino Rojo Project mine pit location. Water quality is very poor and non-potable (Table 24-2). The community apparently does not have water treatment, and potable water is either obtained from sources outside the community or from local sources, such as precipitation or runoff. CNA-156 is a dug well (noria) in the center of town, and is reportedly only used for stock watering because of its poor quality (Table 24-2). CNA-158 is a drilled well in La Fábrica but is reportedly not used.

El Berrendo. Water supply for this community of 149 residents has historically come from well CNA-139, which is fairly shallow (80 m) and apparently completed within alluvium or Caracol Formation. The well is approximately 7 km from the Camino Rojo Project mine pit location. The relatively good water quality in this well indicates that the primary source of water to this well is local recharge, probably from the adjacent surface impoundment. The community has reverse osmosis (RO) treatment for potable needs.

The El Berrendo well had reportedly been nonoperational, and at the request of ejido El Berrendo for assistance, Minera Camino Rojo (MCR) personnel supervised logging and redeveloping the well and repairing and resetting the pump. This was accomplished in the fall of 2019. The well and RO system now supplies the potable water needs for El Berrendo community and surrounding areas.

San Francisco de los Quijano. This is a community of 57 residents. Water supply comes from two dug wells (CNA-141 and -142) and from drilled well CNA-149. The wells are approximately 6 km from the Camino Rojo Project mine pit location. Water quality in the dug wells is not known, but water use appears to be limited to stock watering and small-scale agriculture. CNA-149 is 237m deep, and is likely completed within the Caracol Formation. The well has been out of operation for at least 6 years and the residents of San Francisco de los Quijano have reportedly been obtaining their drinking water from El Berrendo. In November 2019, MCR personnel supervised the redevelopment, testing, and replacement of electrical components at this well, which is now functioning. Because of the poor water quality in CNA-149 (Table 24-2), it would not be considered as a source of potable water to the community without additional treatment.

Table 24-1
Summary of Groundwater Quality Analyses from On-Site (COPE) Wells

Analyte	Units	Well I.D.	CR-01	CR-01	CR-01	CR-01	CR-03	CR-03	CR-03	CR-03	CR-03	CR-04	CR-04	CR-04	CR-04	CR-04	NOM-127
		Date Sampled	8/15/2018	1/14/2019	1/15/2019	5/30/2019	8/14/2018	11/21/2018	3/21/2019	6/11/2019	10/8/2019	8/14/2018	11/21/2018	3/21/2019	6/11/2019	10/8/2019	Regulatory Limit
		Detection Limit															
pH	UpH	NA	7.16	7.14	7.21	6.98	7.58	7.67	11.2	7.6	7.59	8.03	7.78	7.91	7.42	7.39	6.5 - 8.5
Conductivity	uS/cm	NA	6,060	6,200	6,260	5,508	5,980	6,470	5,470	5,540	5,802	12,260	13,000	13,150	13,000	12,880	
Total Alkalinity	mg/l CaCo3	1	102	157	168		161	176	173	135	73.8	33	43	47	40	40	
Chloride	mg/l	1	811	793	788	794	420	352	357	370	325	1,509	1,536	1,509	1,577	1,577	250
Total Hardness	mg/l CaCo3	5	1,788	1,994	2,024	2,020	1,629	1,780	194	1,700	1,520	4,900	4,300	3,880	3,850	4,000	500
Fluoride	mg/l	1	0.57	0.68	0.73	0.84	0.46	0.40	<0.1	0.33	0.35	0.85	0.94	0.98	1.13	0.83	1.5
Nitrogen (Nitrite)	mg/l	1	< 0.08			< 0.08	< 0.08	< 0.08	<0.08	<0.08	<0.08	4.03	0.77	1.06	0.658	1.1	0.5
Total Dissolved Solids	mg/l	NA	5,163	5,315	5,386	5,273	5,487	5,571	3,963	5,604	5,231	12,583	11,974	12,667	12,447	12,528	1,000
Sulfate	mg/l	100	2,656	2,411	2,438	2,848	3,307	3,270	2,159	3,700	3,519	1,545	1,536	1,557	1,687	1,580	400
Mercury	mg/l	1	<0.0005	<0.0005	<0.0005	<0.0005	<0.0005	<0.0005	<0.0005	<0.0005	<0.0005	<0.0005	<0.0005	<0.0005	<0.0005	<0.0005	0.025
Sodium	mg/l	10	843	761	887	782	767	283	966	413	974	1,010	478	1,319	596	1,346	200
Aluminum	mg/l	1	<0.05	<0.05	0.077	<0.05	<0.05	<0.05	<0.05	<0.05	<0.05	0.16	<0.05	0.13	0.25	0.067	0.2
Chromium	mg/l	1	<0.005	<0.005	<0.005	<0.005	<0.005	0.0060	<0.005	<0.005	<0.005	<0.005	0.0083	<0.005	<0.005	<0.005	0.05
Manganese	mg/l	10	0.082	0.46	0.48	0.32	0.21	0.20	<0.005	0.28	0.35	0.30	0.21	0.24	0.29	0.49	0.15
Iron	mg/l	10	100	3.47	4.78		8.39	10.60	0.28	9.94	9.85	5.03	2.85	9.47	11.00	11.50	0.3
Copper	mg/l	1	<0.005	0.0073	0.0078	0.0079	0.025	0.014	0.010	0.019	0.025	0.013	0.019	0.036	0.040	0.033	2
Zinc	mg/l	10	2.2	1.13	1.53	1.00	3.04	1.25	100	1.59	0.82	4.29	2.19	1.67	2.46	1.81	5
Arsenic	mg/l	10	0.020	0.16	0.27	0.13	<0.005	<0.005	<0.005	<0.005	<0.005	<0.005	<0.005	0.0055	<0.005	<0.005	0.025
Cadmium	mg/l	1	<0.005	<0.005	0.014	0.13	<0.005	<0.005	<0.005	<0.005	<0.005	<0.005	<0.005	<0.005	<0.005	<0.005	0.005
Barium	mg/l	1	<0.005	0.012	0.020		0.013	0.014	0.010	0.014	0.040	0.092	0.086	0.089	0.097	0.092	0.005
Lead	mg/l	1	<0.005	0.016	0.067	0.046	<0.005	<0.005	<0.005	<0.005	<0.005	<0.005	<0.005	<0.005	<0.005	<0.005	0.01
Nitrogen (Nitrate)	mg/l	NA	1.3	0.4	0.36	0.28	0.11	<0.10	<0.10	<0.10	<0.10	1.031	1.63	<0.10	<0.10	0.99	10
Nitrogen (NH3)	mg/l	NA	< 0.50	< 0.058	< 0.058	< 0.058	< 0.50	< 0.058	< 0.058	< 0.058	< 0.058	1.4	0.54	0.58	1.08	1.93	0.5

Table 24-2
Summary of Groundwater Quality Analyses from Community Wells

Well I.D.	CNA-156 (NORIA SAN TIBURON)	CNA-156 (NORIA SAN TIBURON)	CNA-156 (NORIA SAN TIBURON)	CNA-139 (EL BERRENDO)	CNA-139 (EL BERRENDO)	CNA-157 (POZO SAN TIBURCIO)	CNA-157 (POZO SAN TIBURCIO)	CNA-149 (San Francisco de los Quijano)	NOM-127		
Date Sampled	15-Aug-18	21-Nov-18	21-Mar-19	14-Aug-18	7-Oct-19	16-Aug-18	10-Oct-19	5-Dec-19	Regulatory Limit		
Easting (WGS84)	247,254	247,254	247,254	237,849	237,849	247,000	247,000	241,345			
Northing (WGS84)	2,672,624	2,672,624	2,672,624	2,679,819	2,679,819	2,667,700	2,667,700	2,671,876			
Analyte	Units	Detection Limit									
pH	UpH	NA	7.22	7.26	7.31	7.15	6.96	7.75	7.60	8.30	6.5 - 8.5
Conductivity	uS/cm	NA	2,660	2,670	3,000	81.9	132.9	341	382	3,080	
Total Alkalinity	mg/l CaCo3	1	173	192	184	362	291	80	79.6	80.6	
Chloride	mg/l	1	73.1	58.2	164	8.02	25.6	462	478	217	250
Total Hardness	mg/l CaCo3	5	1,664	1,680	1,730	228	400	741	910	134	500
Fluoride	mg/l	1	1.11	1.42	1.57	1.93	1.82	0.87	0.83	0.5	1.5
Total Dissolved Solids	mg/l	NA	2,808	2,509	2,988	582	929	2,734	2,804	2,029	1,000
Sulfate	mg/l	100	1,654	1,576	1,605	95.9	340	1,172	1,147	642	400
Sodium	mg/l	10	182	30.8	144	<0.005	<0.005	<0.005	0.015	713	200
Aluminum	mg/l	1	<0.05	<0.05	<0.05	<0.05	<0.05	<0.05	<0.05	0.58	0.2
Chromium	mg/l	1	<0.005	<0.005	<0.005	<0.005	<0.005	<0.005	<0.005	<0.005	0.05
Manganese	mg/l	10	<0.005	0.041	0.021	<0.005	<0.005	<0.005	0.0091	0.22	0.15
Iron	mg/l	10	0.088	<0.05	0.068	<0.05	<0.05	<0.05	0.32	2.25	0.3
Copper	mg/l	1	<0.005	<0.005	0.0062	<0.005	<0.005	<0.005	0.019	0.036	2
Zinc	mg/l	10	<0.005	0.027	0.022	<0.005	0.0061	0.0081	0.0360	0.2800	5
Arsenic	mg/l	10	<0.005	0.007	0.0058	<0.005	<0.005	<0.005	<0.005	<0.005	0.025
Cadmium	mg/l	1	<0.005	<0.005	<0.005	<0.005	<0.005	<0.005	<0.005	<0.005	0.005
Barium	mg/l	1	<0.005	0.032	0.028	0.097	0.014	<0.005	0.028	0.028	0.005
Lead	mg/l	1	<0.005	<0.005	<0.005	<0.005	<0.005	<0.005	<0.005	<0.005	0.01
Nitrogen (Nitrate)	mg/l	NA	0.82	<0.10	<0.10	3.1	0.27	16	<0.10	0.44	10
Nitrogen (NH3)	mg/l	NA	<0.50	<0.058	<0.058	<0.50	<0.058	<0.50	<0.058	<0.058	0.5

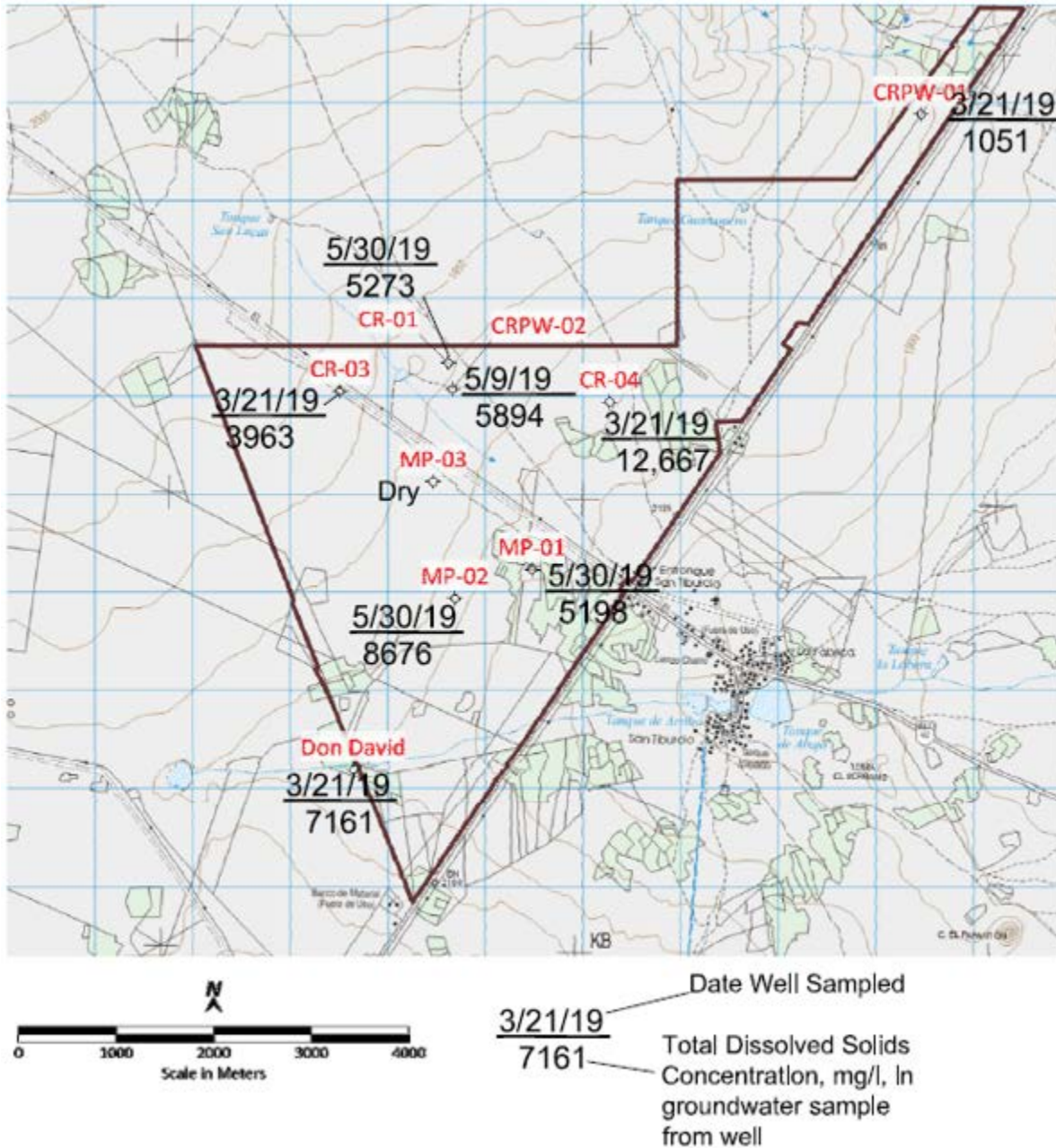

Figure 24.4 Total Dissolved Solids in Groundwater

24.4.3 Drilling and Aquifer Testing

A test drilling program was undertaken in order to identify possible location(s) for construction of water supply well(s). The test drilling program included the drilling of 14 test borings in the area where the company has surface rights (COPE), using the reverse-circulation air (RC) drilling method. In general, the drilling results from boreholes drilled in the Caracol Formation were not encouraging, other than for CR-01 (completed in the Caracol Formation within the boundary of

the proposed pit). Aquifer tests of CR-01 indicated that significant quantities of water could be withdrawn from wells in fractured portions of the Caracol (Barranca, 2019a).

Several borings were drilled in the vicinity of CR-01 in an attempt to intersect the fracture systems that may be supplying water to this hole. Water production from these borings was very low, suggesting that major water bearing structures in the Caracol Formation may be concentrated and of limited extent. The PW-2 aquifer test conducted in May 2019 verified that the Caracol has very low permeability where not fractured.

A test boring in the extreme northeast corner of the COPE (CRW18-13) encountered the Cuesta del Cura Formation at a relatively shallow depth, and there appeared to be significant water production from this formation. It was decided to drill and construct a test production well at this location (Barranca, 2019b). The seven-day pumping test conducted at PW-1 indicated that the well should be capable of supplying mine process requirements. Based on the pumping test results, the maximum production at PW-1 is approximately 32 L/s, although the long-term yield from this well may be less. Although PW-1 appears to be able to provide a sufficient water supply for the project, additional back up well capacity should be developed.

24.4.4 Groundwater Simulations of Projected Mine Dewatering

A groundwater model of the regional aquifer including the Project area was developed to evaluate the projected impacts of dewatering and mine pumping, and to predict potential dewatering rates. The model boundaries are shown in Figure 24.1. The objectives of this modeling were to evaluate:

- The extent of the cone of depression resulting from mine operations,
- The rate of pit dewatering required as the mine excavation progresses,
- The period of pit lake recovery and final pit lake elevation.

Current mining plans for the “unconstrained pit” option anticipate 9 years of active pit excavation. By the 5th year the excavation is expected to reach the level of the pre-mining water table and for the remaining 5 years of excavation pit dewatering activities should be anticipated. The depth of the unconstrained pit will be 280 metres, or 150-155 metres beneath the pre-mining water table.

The groundwater model was developed encompassing approximately 1,200 square kilometres of the Cretaceous aquifer within portions of the El Cardito and Guadalupe Garzarón administrative basins (Figure 24.2). The simulation of groundwater flow assumed that the aquifer is currently in equilibrium with respect to recharge and discharge, as regional groundwater development appears to be minimal.

24.4.5 Summary of Simulation Results

Model calibration to steady-state regional conditions was based on published groundwater levels, aquifer test results, and groundwater flow estimates. Project site test results were used to help define the aquifer properties and constrain the dewatering simulations using a range of hydraulic conductivities developed during model calibration. The overall calibration to assumed regional steady state and Project site testing results is considered reasonable.

Two dewatering scenarios were developed that would encompass the expected range of measured Project site hydrologic properties and were in agreement with the model calibration results. Two cases, “high K” and “low K”, were modeled. Both cases simulated 5 years of groundwater pumping for mine process water, 5 years of active pit dewatering, and more than 100 years of aquifer recovery.

Simulated maximum mine pit dewatering ranged from 53 to 74 liters/second for the low and high K cases, respectively during the final year (year 9) of mining. Simulated dewatering rates over the life of mine are shown for both cases in Figure 24.5.

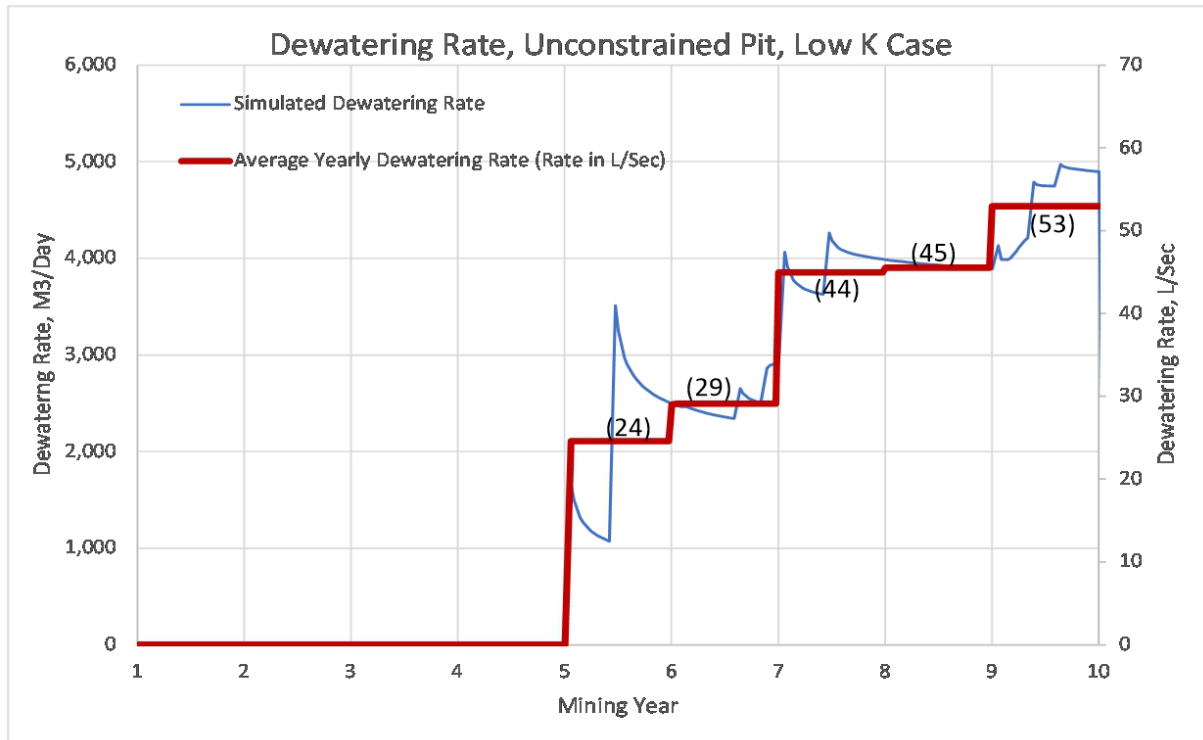
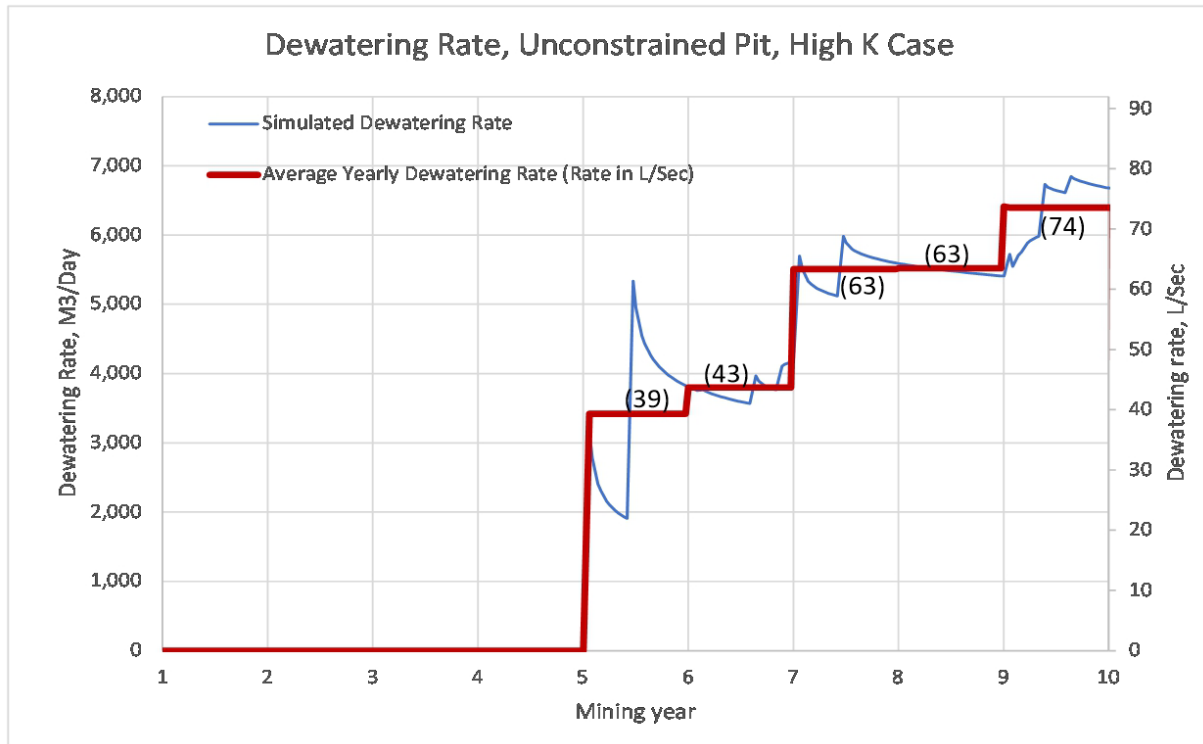

Figure 24.5 Simulation Dewatering Rates for Law and High K Scenarios, Camino Rojo Project, Zacatecas

The impacts to the regional aquifer were evaluated by comparing the extent of the 1-metre decline (drawdown) in water levels due to mine dewatering. For the high K case, the maximum extent of 1-metre drawdown averaged approximately 15 kilometres from the mine pit, occurring about 60 years after cessation of mining, as shown in Figure 24.6. For the low K case, the maximum extent averaged approximately 13 kilometres from the mine pit, occurring about 100 years after cessation of mining, as shown in Figure 24.7.

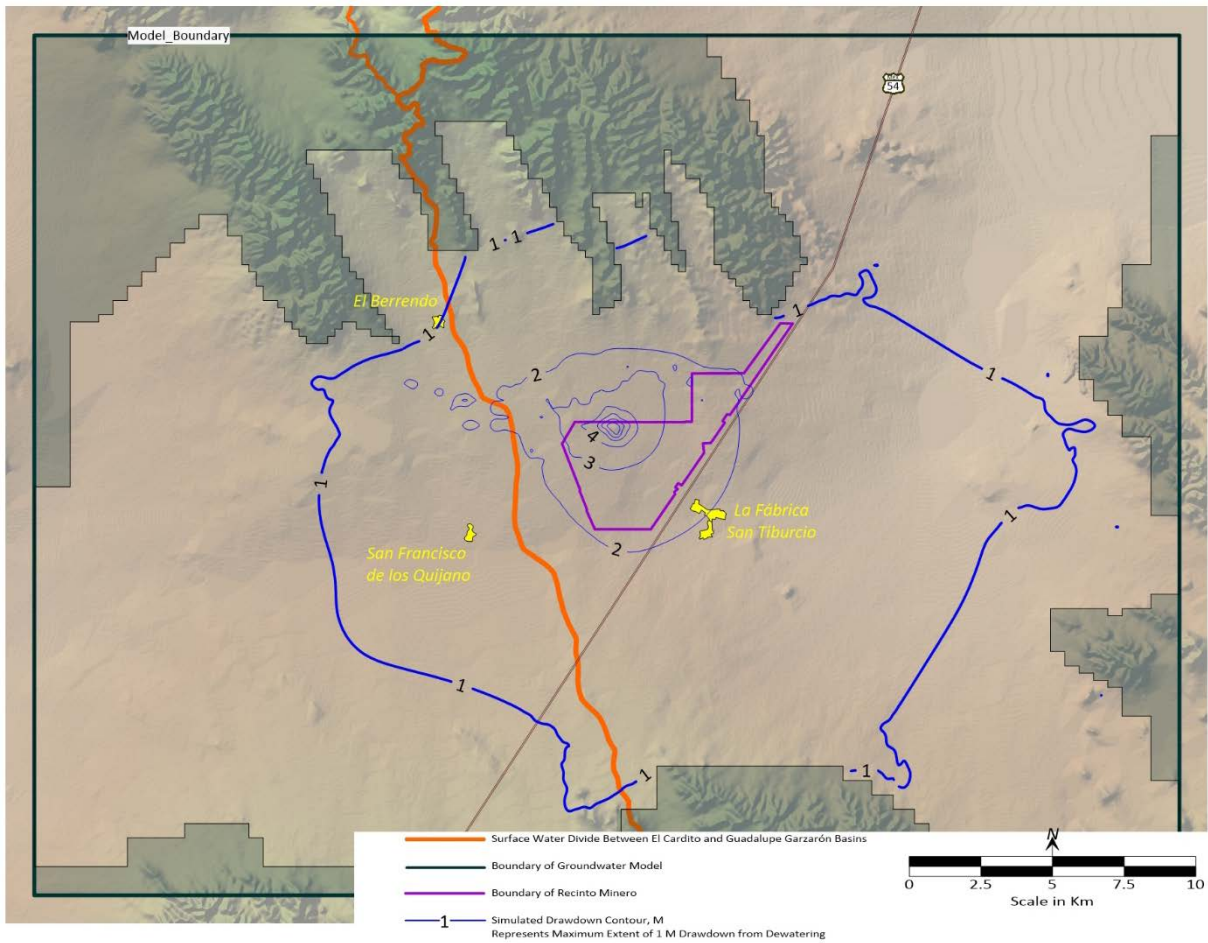

Figure 24.6 Simulated Extent of 1 Metre Drawdown Contour for High K Case, Camino Rojo Project, Zacatecas

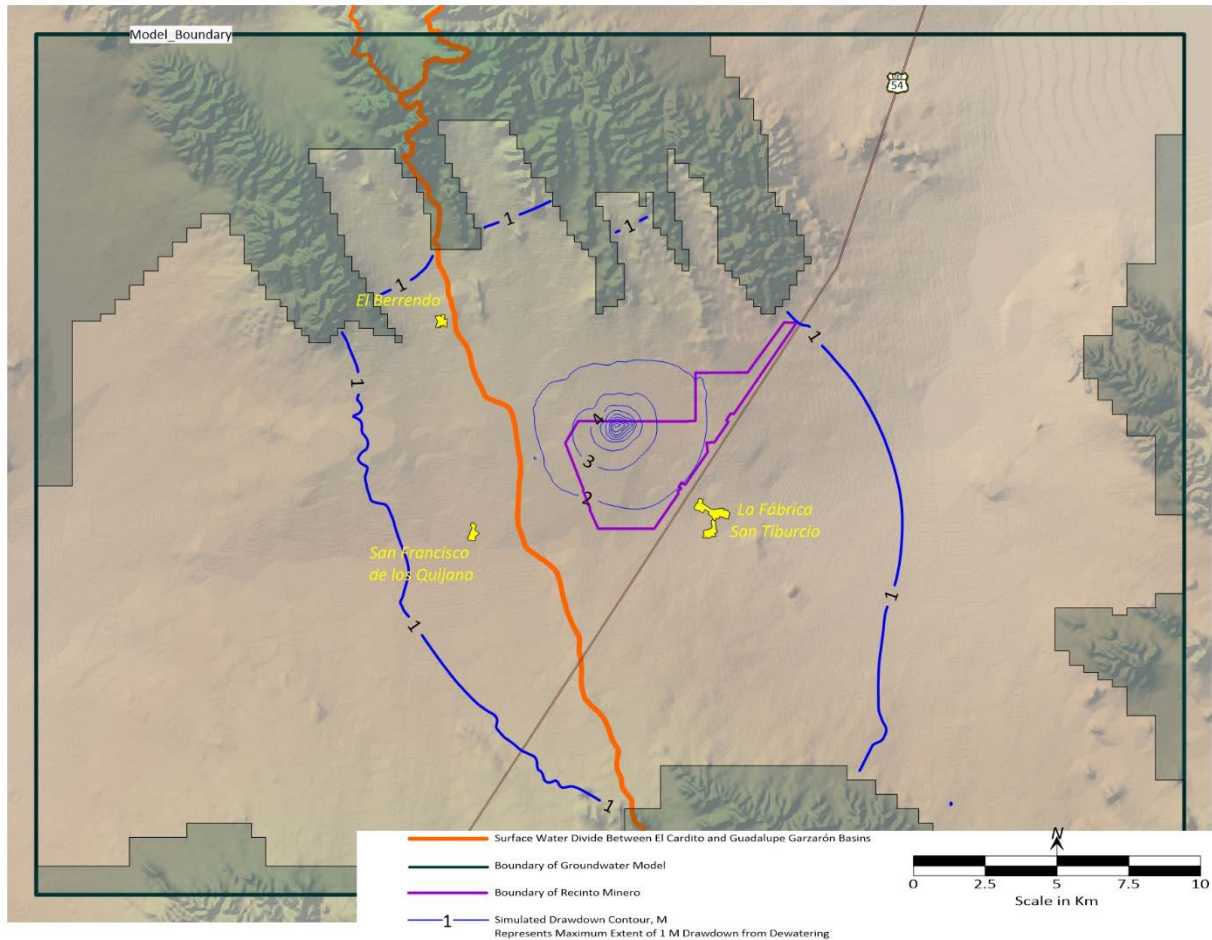

Figure 24.7 Simulated Extent of 1 Metre Drawdown Contour for Low K Case, Camino Rojo Project, Zacatecas

Recovery of groundwater levels after cessation of dewatering was simulated for both cases. Simulated pit lake water levels stabilized between approximately 40 and 60 years after dewatering ceased for the high and low K cases, respectively. Regionally, the simulated stabilized water levels showed the pit lake to be a groundwater sink in terms of lateral groundwater flow.

24.4.6 Model Limitations

The model simulations were developed to provide a range of plausible estimates of 1) pit dewatering rates during the 5-year mining period that dewatering will be required; 2) pit inflow rates during pit recovery and final pit lake water levels; and 3) impacts to regional groundwater levels from mine dewatering. The model was not constructed or calibrated for any other purpose.

This groundwater model is based on interpretation of currently available data. The data sparseness in the area of the regional model, and the natural variability associated with porous and fractured hydrogeologic media preclude making definitive statements about areas not directly

associated with the tested wells. Actual conditions may vary from model predictions, but are expected to be within or close to the range described. Because the modeled hydraulic properties do not span the entire range of aquifer test results, model projections should be interpreted as being average impacts, and should not be viewed as a predictor of impacts in specific areas. These projections also do not show the short-term variability resulting from seasonal or other fluctuations of atmospheric parameters.

24.5 Sulphides

The oxide and transition material that is the subject of this Technical Report is underlain by sulphide material that is amenable to milling and flotation concentration methods. The Measured and Indicated Mineral Resources amenable to milling and flotation total 258.8 million tonnes at 0.88 g/t Au, 7.4 g/t Ag, 0.07% lead, and 0.26% zinc. Contained metal amounts to 7.30 million ounces gold, 61.6 million ounces of silver, 409.2 million pounds of lead, and 1.49 billion pounds of zinc. No part of this resource is considered in the Feasibility Study. However, the heap leach pad and mine waste rock dump were placed such that they would not need to be moved should a large open pit be developed to mine the sulphide material.

A possible process flowsheet for the sulphide material is a sequential flotation process consisting of an initial pre-flotation to remove organic carbon followed by lead flotation, zinc flotation, and pyrite/arsenopyrite flotation to recover additional precious metals. The pyrite/arsenopyrite concentrate would be oxidized to recover additional gold and silver by cyanide leaching. Payable products would be the lead concentrate, zinc concentrate, and gold/silver doré recovered from the cyanide leaching of the pyrite/arsenopyrite concentrate.

25.0 INTERPRETATIONS AND CONCLUSIONS

25.1 Conclusions

The Camino Rojo open pit mine and heap leach facility described in the 2019 Technical Report is currently under construction and the site work and feasibility investigations that have been completed to date demonstrate that the Project described in this Technical Report is a technically feasible and economically viable endeavor. The Project is conveniently located with access via Mexican highway 54 which connects the major cities of Zacatecas and Saltillo. The Project terrain is predominately flat and sufficient water for operations is available from wells located at the Project site. Required mineral, surface and water rights for the project described in the 2019 Technical Report have been secured. The Layback Agreement with Fresnillo, subject to approval by COFECE, and the subsequent transfer of surface rights, provide the additional mineral and surface rights required for the expanded project described in this Technical Report. Approval by COFECE is expected to be received in a timely manner.

More specific and detailed conclusions are presented in the Sections below.

25.1.1 Mining

The Camino Rojo mine will be a conventional open pit mine. The mine plan developed as the base case for this Technical Report has identified 67.4 million tonnes of ore at an average grade of 0.73 g/t Au and 14.5 g/t Ag. This amounts to 1.59 million contained ounces of gold and 31.5 million contained ounces of silver. The mine life is about 10.4 years and the life of mine strip ratio is 0.92 to 1, a relatively low ratio for a precious metal pit.

Pit operation should be relatively simple compared to most projects in Mexico. The ground in the deposit area is flat, and the haul distances to the proposed crusher and waste storage areas are only about 500m and a kilometre from the pit rim respectively.

25.1.2 Metallurgy and Process

The Project has been designed as an open-pit mine with heap leach for recovery of gold and silver from oxide and transition material. Ore will be crushed to P₈₀ 28mm, stockpiled, reclaimed and conveyor stacked onto the heap leach pad at an average rate of 18,000 tonnes/day. Stacked material will be leached using low grade sodium cyanide solution and the resulting pregnant leach solution will be processed in a Merrill-Crowe plant for the recovery of gold and silver by zinc cementation followed by drying and smelting to produce the final doré product.

Metallurgical test work completed indicates that the material is amenable to cyanide leaching for the recovery of precious metals with overall recoveries of 62% for gold and 20% for silver with

low to moderate reagent consumptions and will produce an estimated 980,000 ounces of gold and 6.2 million ounces of silver. Cement agglomeration is not required for heap heights up to 80m with only lime being required for pH control.

Potentially preg-robbing material has been identified within the Camino Rojo ore body. A significant campaign was carried out to identify the material associated with preg-robbing with results indicating that the potentially preg-rob material is only a minor component of the total material and is found primarily at depth and is associated with the transition material with almost none of the oxide showing preg-robbing tendencies. Deleterious effects from preg-robbing should be able to be mitigated with proper ore control toward the end of the project life.

25.1.3 Environmental and Permitting

MCR currently has all major permits required for construction and operation of the project described in the 2019 Technical Report. Certain permits, including authorization from SEDENA to use and store explosives, cannot be obtained before facilities are built, and routine surface water management permits from CONAGUA, required for constructing surface drainage diversion works and road crossings, are in progress. Receipt of these permits is not expected to affect project timelines. There are no impediments to construction, mining, and processing activities for the already authorized project while permit modifications for the project described in this Technical Report are in the application process.

Site investigations and works completed as part of the Feasibility Study are intended to support and advance the permitting process for the Camino Rojo mine. Baseline environmental studies required for permitting have been completed with continued and ongoing monitoring in progress.

MIA and CUS permit applications were submitted to SEMARNAT on 29 and 30 August 2019 respectively for the construction and operation of an open pit mine as per the project described in the 2019 Technical Report. Federal environmental authorities approved the CUS permit in December 2019. MCR made the requisite payment to the National Forestry Commission (Comision Nacional Forestal) on 23 January 2020, and MCR received the CUS permit on 6 February 2020, via Oficio No. DFZ152-201/20/0196, allowing mine development and operation affecting 816.25 ha. MCR received the MIA permit on 11 August 2020, via Oficio No. SGPA/DGIRA/DG/03478, authorizing mine construction and operation of the project as described in the 2019 Technical Report. The project described in this Technical Report will require obtaining an additional CUS permit, and at the discretion of SEMARNAT, an additional MIA permit or a modification of the existing MIA permit, to allow for additional surface disturbances and production related to development of a pit layback onto lands not considered in the August 2019 permit applications. Process methods and process infrastructure do not change. The additional CUS permit is expected to require 3 months for preparation of the application, and an additional 6 months for review and issuance of resolution by SEMARNAT.

The MIA permit modification or additional MIA permit is expected to require 3 months for preparation of the application, and an additional 6 months for review and issuance of resolution by SEMARNAT.

The Project is not located in an area with any special Federal environmental protection designation and no factors have been identified that would be expected to hinder authorization of required Federal and State environmental permits.

The Project area includes five flora species with legally protected status and nine fauna species are listed as threatened or protected. In accordance with Federal laws, 100% of the protected plants will be rescued and transplanted prior to construction and qualified biologists will survey the areas to be disturbed to identify nesting areas, dens and lairs of animals present. Any animals not naturally prone to leave the area that are found will be relocated to suitable habitats elsewhere in the property area.

Based on the Mineral Reserves developed for this Project and results from environmental test work, the heap leach Project material has an overall neutralization potential ratio of 3.9 and is classified as non-acid forming. Tests completed by rinsing leached material with water indicate concentrations of metals and cyanide decreased with rinsing, and were within standards applicable to the site as presented in NOM-001-SEMARNAT-1996 (metals limits for discharge for agricultural use) and NOM-155-SEMARNAT-2007 (cyanide limits for heap leach mining) for all metals with the exception of arsenic. Results from SPLP and humidity cell tests imply that the source of the arsenic is not due to cyanide leaching, but rather weathering of the oxide and transitional ore. Consistent with this evaluation, arsenic is also elevated in the natural groundwater based on sample testing of well CR-01 in the pit area (Section 20.1.2.2). The Project considers designs and procedures to ensure that the elevated arsenic levels do not result in environmental degradation around the Project site.

Based on an independent assessment of social and community impacts of development of the Project completed by ERM, the Project does not put at risk the social environment of the nearby communities because the impacts can be mitigated or made positive with the implementation of a Social Management System (SMS). Orla plans to develop the Project in accordance with International Finance Corporation Performance Standards, as well as the International Council on Mining and Metals principles.

Baseline environmental studies and social and community impact investigations are ongoing. Based on the information and conclusions available, there are no environmental or social reasons preventing the development of the Project.

25.2 Opportunities

25.2.1 Mining

As part of the Layback Agreement, Orla has the right to mine and recover all heap leachable material located on the Fresnillo mineral concession in a pit mined for oxide and transitional material that is covered by the Layback Agreement. Any oxide or transitional material amenable to heap leach recovery would allow additional gold and silver production to Orla's account. Fresnillo drilled approximately 63 core holes totaling 33,253 metres and targeting both near surface oxide mineralization and deep sulphide mineralization in the surface area covered by the Layback Agreement. Orla has received the drill data from Fresnillo but has not yet independently verified the results or undertaken any QA/QC analysis. However, results from Fresnillo holes drilled in close proximity to the most northern holes on the Orla property appear to be consistent with projections of the geological and oxidation models created from Orla's data and assay results appear to be consistent with projections of Orla's Mineral Resource model.

25.2.2 Mineral Resource

In addition to the Mineral Resource amenable to heap leaching, the Feasibility Study has identified a Measured and Indicated Mineral Resource of sulphide material that is amenable to milling and flotation concentration of 258.8 million tonnes at 0.88 g/t Au and 7.4 g/t Ag. This amounts to 7.3 million contained ounces of gold and 61.6 million contained ounces of silver. Additional metallurgical, mining, process, environmental and other studies are required to further evaluate potential economic parameters for this material. An additional agreement with Fresnillo will be required to exploit the sulphide material by open pit mining methods, as the current Layback Agreement only covers a portion of the resource amenable to heap leaching. The selected heap leach pad and mine waste dump location have been situated to allow an open pit to be developed on the sulphides without requiring them to be moved.

25.2.3 Metallurgy and Process

Due to the uniform topography of the Camino Rojo property, earthworks quantities needed for elevating the haul roads to meet the required height of the primary crusher incur large capital costs. Utilizing a decoupled system (a conveyor at lower elevation to feed the crusher) would decrease initial earthworks quantities as well as fuel requirements from truck haulage throughout the life of the Project.

Leaching cycles have been designed for 80 days, but laboratory results have shown that silver recoveries benefit from cyanide solution application beyond the 80-day period. With subsequent lifts, draindown from active lifts will result in extended leaching times on previously leached lifts. As a result of this, silver recoveries are expected to increase over the LOM of the Project.

Oxidative treatment testwork was conducted by KCA in 2020 and consisted of an alkaline atmospheric oxidation process as a pre-treatment for heap leach material. This testwork concluded that there is an opportunity to increase recoveries on transition and mixed sulfide material when heap leaching with a sodium cyanide solution.

25.2.4 New Mineral Zones

The Camino Rojo deposit occurs within a mineralized district that is highly prospective for discovery of additional deposits. New discoveries of Mineral Resources in the vicinity of the proposed mine may be accretive to project value.

25.3 Risks

25.3.1 Mining

The Project uses contract mining as part of the base case study. There are some specific risks related to contract mining. There is risk that the contractor may need financial assistance from the owner either in terms of cash, or loan guarantees, to procure some equipment, increasing the capital cost. Contract mining is common in Mexico and this risk can be minimized by careful evaluation of potential contractors.

By Year 5 of commercial operations the pit depths will be below the pre-mining water table and dewatering operations are anticipated. Cost estimates of these operations have been based on an expected range of dewatering rates provided in Ward (2020). Dewatering requirements outside of this range are possible due to the inherent inability to completely describe groundwater conditions in advance of mining. There is a risk that the estimated pit dewatering costs may change as a result of changed dewatering requirements.

25.3.2 Metallurgy and Process

Carbonaceous material with preg-robbing characteristics has been identified, which may reduce overall heap performance and metal recovery if processed. In regards to gold and silver recovery the Camino Rojo deposit shows preg-robbing organic carbon as being the only significant deleterious element identified, which is primarily associated with the transition material at depth along the outer edges of the deposit. Preg robbing presents a low risk to the overall Project. A significant investigation by Orla into the preg robbing material which was reviewed by KCA indicates that preg robbing material will most likely not be encountered until later in the Project life and can be mitigated by proper ore control.

Evaporators for pit dewatering require a minimum operating depth in the pond for operation which is assumed to be approximately 1.5 metres, or approximately 46,500 m³ of solution. Based on the pond sizing criteria there is sufficient capacity in the event pond to accommodate this

additional solution for the planned heap without any changes. However, evaporation rates of water from the pit may not consistently be as estimated which may lead to some periodic loss of pond storage.

There is a risk that Merrill-Crowe efficiencies may be poor, particularly during initial operations due to low pregnant solution concentrations. This may result in increased zinc consumption and delayed metal recoveries.

25.3.3 Access, Title and Permitting

The Project is subject to normal risks regarding access, title, permitting, and security. The Project has had a productive relationship with the surface owners and no extraordinary risks to Project access were discerned. Conditional upon continued compliance with annual requirements, no risk to validity of title was discerned. Conditional upon compliance with applicable regulations, permits for normal exploration activities, mine construction, and mine operation are expected to be attainable. Drug related violence, propagated by members of criminal cartels and directed against other members of criminal cartels, has occurred in the region and has affected local communities. The aggression is not directed at mining companies operating in the region and has not affected the ability of Orla or previous operators to explore the Camino Rojo property.

The Project is subject to similar risks as comparable projects, however, Orla believes it has mitigated many of those risks by early engagement with the stakeholders involved in the project, including government permitting agencies, local land holders, including the Ejidos and Fresnillo, and the advanced stage of activities around mine construction and long-lead time mine equipment. Purchase and construction of required process and other infrastructure is already underway under the plan outlined in the 2019 Technical Report. Permits for the Project currently being built were received and the expanded Project requires comparatively minor permit additions and amendments. Construction and operation of the permitted portion of the Project can continue unaffected as additional permitting requirements are met. Completion of the Layback Agreement remains subject to COFECE approval. The Feasibility Study detailed herein assumes receipt of COFECE approval and subsequent transfer of surface rights.

In recent years, some mining projects in Mexico have suffered development delays or production stoppages as a result of community interference. Orla has an active community relations and social program and strives to maintain constructive relationships with local communities. Management believes that maintaining a robust community relations program can reduce and mitigate social risks and improve overall operational sustainability.

Under Mexico's current COVID-19 legislation, mining and construction are permitted economic activities and the Camino Rojo Project site is operating in compliance with the Mexican Health Authority and Company requirements. Orla has implemented a strict COVID-19 protocol,

including rigorous screening and testing programs to support the health of Orla's employees and local communities. The Company is closely monitoring the potential impacts from the pandemic on areas including equipment delivery and logistics, materials for construction and operation, other necessities, as well as construction costs and schedule, and community and government relations. While some delays to construction and permit amendments may occur due to the COVID-19 pandemic, Orla has taken steps to minimize potential impacts to the overall Project including additional costs related to COVID-19 safety measures.

Closing of the Layback Agreement is subject to receipt of Mexican antitrust approval from the Federal Competition Commission (Comisión Federal de Competencia Económica (COFECE)).

Federal environmental authorities issued a Change of Land Use Permit for the Camino Rojo Project on 6 February 2020, allowing mine development and operation affecting 816.25 ha as per the Project described in the 2019 Technical Report. Receipt of the Change of Land Use permit minimizes the risk of a possible Federal designation of a protected biological-ecological reserve that could affect the project. On 24 June 2014, SEMARNAT published a public notice in the Official Gazette of the Federation requesting public consultation and comments on the possible designation of an area known as "Zacatecas Semi-arid Desert" as a Natural Protected Area ("ANP"). The proposed area for designation is located in the Municipalities of General Francisco Murguía, Villa de Cos, El Salvador, Melchor Ocampo, Concepción del Oro and Mazapil, in the State of Zacatecas (CONANP, 2014). The proposal for the ANP was created by the Comisión Nacional de Áreas Naturales Protegidas (CONANP). CONANP does not have legal authority to designate the ANP, this power being reserved for the Executive branch of Mexican Federal government. If a designation of this ANP by the government includes the surface of the mining concession areas or immediately adjacent areas, this could limit the growth and continuity of the project. However, since the time that the proposal to create this ANP was first published in the Official Gazette of the Federation, there has been no formal Federal movement on the proposal and State and municipal governments affected by the Camino Rojo Project have formally expressed opposition to creation of an ANP in the area of the Camino Rojo Project. The authors of the Camino Rojo Report believe that the approvals and permitting risk for the project is similar to that of any mining project of similar scope in North America.

25.3.4 Other Risks

An ecological tax implemented by the state Congress of Zacatecas in 2017 could have a significant impact on the economics of the Project. This tax is applied to cubic metres of material extracted during mining, square metres of material impacted by dangerous substances, tonnes of carbon dioxide produced during mining processes and tonnes of waste stored in landfills. Due to the uncertainty of application of this tax and turbulence between active mining companies and the State of Zacatecas, the long term effects and implementation of this ecological tax are currently unknown.

The primary Project production well (PW-1) underwent a 10,000-minute pumping test and a sustained flow of 32 L/s was maintained. There is a risk, however, that the long-term productive capacity of well PW-1 will not be maintained due to the nature of fracture- or solution-enhanced secondary permeability, and that the yield of the well may diminish. Development of additional production capacity, as recommended, will mitigate this risk.

The Feasibility Study and the Camino Rojo Project may be subject to legal, political, environmental or other risks that could materially affect the development of the Camino Rojo Project which are unknown at this time but could materialize in the future.

26.0 RECOMMENDATIONS

26.1 KCA Recommendations

This Technical Report presents an economically robust project. Based on these results, KCA recommends the following future work in regards to process and infrastructure development:

- Oxidative metallurgical testwork should continue to be advanced in order to gain a better understanding of the metallurgical parameters involved in the application of oxidation processes and improved recoveries on transition and mixed sulphide materials at the Project. Estimated costs for this are approximately US\$100,000.

26.2 RGI Recommendations

In addition to the continuing the exploration work already underway, RGI recommends a phased exploration program. Phase 1 consists of:

- An estimated 2,500 metres of drilling and detailed QA/QC on the Fresnillo data, and integration of Orla's geological and resource models with the Fresnillo drill data to enable material on the Fresnillo mineral concession to be included in the Measured and Indicated Mineral Resource category, which will then allow the material to be considered in an updated Mineral Reserve estimate.
- 950 line-km of induced polarization (IP) geophysical surveys to seek additional mineralized zones concealed by colluvium.
- 7,500m of RAB drilling to seek additional mineralized zones concealed by colluvium
- A 5,000m core drill program to evaluate the sulphide resource underlying and adjacent to the oxide and transition mineralization that is the focus of this Technical Report, with the goal of defining mineralization that may be economically processed through a mill and flotation plant.
- A 5,000m RC drill program to test IP anomalies already identified.

Phase 2, which is conditional upon identification of new IP anomalies or targets identified by RAB drilling, comprises:

- A 5,000m RC drill program to test newly defined IP anomalies.
- A 5,000m core drilling program to evaluate the mineralized zones thus discovered.

The total estimated cost to complete the first phase of recommended exploration work is US\$3.70 million. Conditional upon positive results from the first phase, the second phase of recommended work is estimated to cost US\$1.80 million.

26.3 John Ward, CPG, Groundwater Consultant Recommendations

John Ward, Groundwater Consultant, recommends the following:

- Exploration and construction of one or more back-up production wells capable of providing water for mine use in case the primary production well (PW-1) is out of service or cannot provide sufficient water.
- Completion of the monitoring well network.
- Estimated costs are US\$350,000 for a backup production well, and US\$375,000 for the monitoring well network.

These estimates are included in the pre-production capital costs (Table 21-3).

27.0 REFERENCES

- Aguayo Hurtado, 2019a, Estudios Ambientales de Línea Base para el Proyecto Camino Rojo. Preparado para: Minera Camino Rojo Preparado por: Delia Patricia Aguayo Hurtado, Servicios Geoambientales. 2019.
- Aguayo Hurtado, 2019b, Manifestación De Impacto Ambiental Modalidad Regional, Proyecto “Camino Rojo”, Municipio De Mazapil, Zacatecas. Preparado para: Minera Camino Rojo, S.a. De C.V., Preparado por: Delia Patricia Aguayo Hurtado, Servicios Geoambientales. Julio, 2019.
- Aguayo, P., (2019), Estudios Ambientales de Línea Base para el proyecto Camino Rojo.
- Aranda-Gomez, J. L.-M.-C., 2006, El volcanismo tipo intraplaca del Cenozoico tardío en el centro y norte de México: Una revision. Boletín De La Sociedad Geológica Mexicana, 187-225.
- Barboza-Gudiño, J. Z.-M.-R.-N., 2010, Late Triassic stratigraphy and facies from northeastern Mexico: Tectonic setting and provenance. Geosphere, 621-640.
- Barranca Group LLC, 2018, Groundwater Conditions – Camino Rojo Project.
- Barranca Group LLC, 2019a, Technical Memo – Camino Rojo Project - Pump Test Summary, Well CR-01. January 2019.
- Barranca Group LLC, 2019b, Camino Rojo Project - Production Well PW-1. April 2019.
- Barranca Group LLC, 2019c, Camino Rojo Project - Heap Leach Area Monitor Wells. June 2019.
- Barranca Group LLC, 2019d, Camino Rojo Project - Well Summary Report PW-2. June 2019
- Barrett, M., 2019 (January), Laboratory Test Results for Orla Mining Ltd Project – Camino Rojo.
- Blanchflower, J. (2009, January 15). Technical Report on the Mineral Resources of the Camino Rojo Property. Technical report posted by the Canplats on SEDAR, January 15, 2009, 70 p: Minorex Consulting.
- Blanchflower, K. K. (2009). Technical Report Preliminary Assessment based on Report Titled "Technical Assessment of Camino Rojo Project, Zacatecas, Mexico", prepared by

- Minorex Consulting Mine and Quarry Engineering Services Inc. for Canplats Resources Corporation, October 16, 2009.
- Blue Coast Research, Ltd., 2013 (September), PJ5119 – Goldcorp Camino Rojo Represa Transition Sample Summary, Prepared for Goldcorp.
- Buseck, P. R., 1966, Contact metamorphism and ore deposition, Concepción del Oro, Mexico. *Economic Geology*, 61(1), p 97-136.
- Centeno-Garcia, E., 2005, Review of Upper Paleozoic and Lower Mesozoic stratigraphy and depositional environments of central and west Mexico: Constraints on terrane analysis and paleogeography. *The Mojave-Sonora megashear hypothesis: Development, assessment, and alternatives: Geological Society of America Special Paper 393*, Anderson, T.H., Nourse, J.A., McKee, J.W., and Steiner, M.B., eds., 233-258.
- CONANP., 2014, Estudio previo justificativo para la declaratoria como Area Natural Protegida Reserva de la Biosfera Desierto Semiarido de Zacatecas. Mexico City, Mexico: Comision Nacional de Areas Naturales Protegidas.
- Cruz-Gómez, E. V.-T.-F.-S.-D., 2017, Volcanic sequence in Late Triassic – Jurassic siliciclastic and evaporitic rocks from Galeana, NE Mexico. *Geologica Acta: an international earth science journal*, 89-106.
- D.B. Stephens & Assoc, 2019, Laboratory Report for Orla Mining Ltd., Project: Camino Rojo. Daniel B. Stephens & Associates, Inc. Feb 4, 2019.
- ERM 2019 Estudio de Impacto Social para el Proyecto Minero “Camino Rojo”, Marzo 2019 Proyecto No.: 0460594”, ERM Consultants Canada Ltd. March 2019
- Ernst & Young, 2017, (May), Metals Tax Summary, Mexico - Mining and Metals Tax Guide.
- Goldcorp, 2016 (September), Pre-Feasibility Study Report, Camino Rojo Project, San Tiburcio, Zacatecas, Mexico.
- Goldcorp Inc., 2017, (March), Goldcorp Annual Information Form for the Financial Year Ending 31 December 2016.
- Gray, M. D., 2016 (December), Site Visit Report, Camino Rojo Gold Project (Goldcorp), Zacatecas, Mexico, Prepared for Orla Mining Ltd. Rio Rico, Arizona, USA: Resource Geosciences Inc.

Gray, M. D, 2018, CSA NI43-101 Technical Report on the Camino Rojo Gold Project, Municipio of Mazapil, Zacatecas, Mexico. Rio Rico, AZ: Resource Geosciences Inc.

Hazen Research Inc., 2014, Camino Rojo Project Variability Study. Golden, Colorado: Hazen Research Inc.

Heiras, M., 2017 (June), Legal opinion letter. Chihuahua, Chihuahua, Mexico: Heiras y Asociados S.C. Abogados.

Heiras, M., 2018 (January), Letter report, Camino Rojo permitting for exploration and Ejido relations. Chihuahua, Chihuahua, Mexico: Heiras y Asociados S.C., Abogados.

Heiras, M., 2019 (July), Legal opinion letter. Chihuahua, Chihuahua, Mexico: Heiras y Asociados S.C. Abogados.

Heiras, M., 2021 (January), Legal opinion letter, Mining Concessions, Surface Rights, Water Rights, Environmental Permits, Fresnillo Layback Agreement for Camino Rojo Project, Zacatecas. Chihuahua, Chihuahua, Mexico: Heiras y Asociados S.C. Abogados.

Huss, C., M3, 2012 (August), Camino Rojo Project Technical Report Prefeasibility Study, Zacatecas, Mexico, Document No. M3-PN100113, Prepared for Goldcorp.

HydroGeoLogica Incorporated, 2019 (January), Final Sampling and Analysis Plan for Supplemental Geochemical Characterization, Camino Rojo Project.

HydroGeoLogica Incorporated, 2020 (January), Camino Rojo – Supplemental Geochemical Characterization Program, Unconstrained Case

HydroGeoLogica Incorporated, 2020 (January), Camino Rojo Pit Lake Evaluation Report, Unconstrained Case.

HydroGeoLogica Incorporated, 2020 (January), Camino Rojo – Waste Rock Management Plan, Unconstrained Case.

HydroGeoLogica Incorporated, 2020 (February), Preliminary Closure Plan for the Camino Rojo Heap Leach Pad—Unconstrained Case.

Independent Mining Consultants, Inc., 2018 (December), Core versus RC Drilling Memo.

Independent Mining Consultants, Inc., 2019 (December), Camino Rojo Mine Production Schedule – 18KTPD Unconstrained Case.

Kappes, Cassiday & Associates, 2010 (April), Camino Rojo Project Report of Metallurgical Test Work, Prepared for Mine and Quarry Engineering Services, Inc.

Kappes, Cassiday & Associates, 2012 (May), Camino Rojo Project Report of Metallurgical Test Work, Prepared for Goldcorp.

Kappes, Cassiday & Associates, 2014 (October), Camino Rojo Project Report of Metallurgical Test Work, Prepared for Goldcorp.

Kappes, Cassiday & Associates, 2015 (August), Camino Rojo Project Report of Metallurgical Test Work, Prepared for Goldcorp.

Kappes, Cassiday & Associates, 2019 (June), Camino Rojo Project Feasibility Capital Cost Details.

Kappes, Cassiday & Associates, 2019 (June), Camino Rojo Project Feasibility Study Equipment List.

Kappes, Cassiday & Associates, 2019 (June), Camino Rojo Project Feasibility Study Process Design Criteria.

Kappes, Cassiday & Associates, 2019 (June), Camino Rojo Project Kp, Ki, TrSx(H), TrHi and TrLo Composites Report of Metallurgical Test Work.

Kappes, Cassiday & Associates, 2019 (June), Project Feasibility Study on the Camino Rojo Gold Project Municipality of Mazapil, Zacatecas, Mexico

Kappes, Cassiday & Associates, 2019 (June), Feasibility Study: NI 43-101 Technical Report on the Camino Rojo Gold Project, Municipality of Mazapil, Zacatecas, Mexico. Prepared for: Orla Mining. Prepared by Kappes, Cassiday & Assoc. June 25, 2019.

Longo, A., 2017, Review of the exploration data for Camino Rojo, Orla Mining Ltd., private company report. Reno, NV.

Longo, A.A., Edwards, J., 2017, Camino Rojo: Observations leading to a new geologic model, and breccia modelling issues, private company report, Prepared for Orla Mining Ltd. Reno, NV.

- Loza-Aguirre, I. N., 2008, Relaciones estratigráfico-estructurales en la intersección del sistema de fallas San Luis-Tepehuanes y el graben de Aguascalientes, México central, pp. 533-548.
- Loza-Aguirre, I. N.-S.-Á.-O., 2012, Cenozoic volcanism and extension in northwestern Mesa Central, Durango, México. *Boletín De La Sociedad Geológica Mexicana*, 243-263.
- Meinert, L.D., Dipple, G.M., and Nicolescu, S., 2005, World Skarn Deposits. In J. T. Hedenquist, *Economic Geology One Hundredth Anniversary Volume 1905 - 2005*. (p. 1136). Littleton, CO: Society of Economic Geologists, Inc.
- Mine Development Associates, 2011 (June), Camino Rojo - A Comparison of Goldcorp and Canplats Drill Results.
- Mitre-Salazar, L., 1989, La megafalla Laramídica de San Tiburcio, estado de Zacatecas. *Univ. Nacional Autón. México, Inst. Geología Revista*, 47-51.
- Montgomery & Associates, 2015, Construction of 2014 Phase 1 Exploration Wells and Results of Pumping Tests, Camino Rojo Project, Zacatecas, Mexico. Consulting Report to Goldcorp.
- NewFields Servicios de México, 2019 (February), Diseño Conceptual de Manejo de Aguas Pluviales y Control de Sedimentación Proyecto Minero Camino Rojo San Tiburcio, Zacatecas Mexico.
- NewFields Servicios de México, 2019 (February), Ingeniería Conceptual Para Manejo de Aguas Pluviales y Control de Sedimentación Proyecto Minero Camino Rojo.
- NewFields Servicios de México, 2019 (February), Revision y Calculo de Precipitación Pluvial del Proyecto Camino Rojo Proyecto Minero Camino Rojo San Tiburcio, Zacatecas Mexico.
- Nieto-Samaniego, A. A.-Á., 2007, Mesa Central of México: Stratigraphy, structure, and Cenozoic tectonic evolution. *Geology of México: Celebrating the Centenary of the Geological Society of México: Geological Society of America, Special Paper 422*, Álvarez, S.A., and Nieto-Samaniego, Á.F., eds., 41-70.
- Ortega-Flores, B. S.-A., 2015, The Mesozoic successions of western Sierra de Zacatecas, Central Mexico: provenance and tectonic implications. *Geology Magazine*, 1-22.

- Piteau Associates Engineering Ltd., 2016 (May), Goldcorp Inc. Camino Rojo Project Prefeasibility Pit Slope Design Study, Geotechnical Investigations and Slope Design Recommendations for the Proposed Oxide and Sulphide Open Pits, Prepared for Goldcorp.
- Piteau Associates Engineering Ltd., 2018 (October), Waste Rock Facility and Heap Leach Pad - Preliminary Stability Analyses.
- Piteau Associates Engineering Ltd., 2019 (April), Slope Stability Assessments and Slope Steepening Using Reinforcement for the North and West Walls of the Camino Rojo: Constrained: Mine Plan.
- Piteau Associates Engineering Ltd., 2019 (April), Waste Rock Facility and Heap Leach Pad - Preliminary Stability Analyses.
- Piteau Associates Engineering Ltd., 2019 (December), Recommended Geotechnical Slope Designs for the Camino Rojo “Unconstrained” Mine Plan.
- Piteau Associates Engineering Ltd., 2020 (March), Geotechnical Review of the Waste Dump and Heap Leach Pad Designs Associated with the “Unconstrained” Mine Plan
- Resource Geosciences Incorporated, 2018 (December), 2018 Drill Program QA QC Report Camino Rojo Project, Municipio of Mazapil, Zacatecas, Mexico.
- Rocha-Rocha, M., 2016 (May), Metallogenesis of the Peñasquito polymetallic deposit: A contribution to the understanding of the magmatic ore system. Doctoral dissertation. Reno, Nevada, USA: University of Nevada Reno.
- Salazar, J.E.H, et al, 2014a, Actualización de la disponibilidad de aguas subterráneas en el acuífero Guadalupe Garzarón, Estado de Zacatecas, Informe Técnico. Preparado por: Departamento de Hydrogeología. June 30.
- Salazar, J.E.H, et al, 2014b, Actualización de la disponibilidad de aguas subterráneas en el acuífero El Cardito, Estado de Zacatecas, Informe Técnico. Preparado por: Departamento de Hydrogeología, Minera Peñasquito. June 30.
- Sanchez, S., 2017 (May), The Mineralogy, Paragenesis And Alteration Of The Camino Rojo Deposit, Zacatecas, Mexico. Master of Science Thesis. Reno, Nevada, USA: University of Nevada, Reno.

- SEMARNAT, Delegacion en el Estado De Zacatecas, Subdelegación de Gestión para la Protección Ambiental y Recursos Naturales., 2013, Oficio No DFZ152-203/13/1675. Zacatecas, Zacatecas: Secretaria de Medio Ambiente y Recursos Naturales, Mexico.
- Servicio Geológico Mexicano, 2000, Carta Geológico-Minero Concepción del Oro G14-10. Pachuca, Hidalgo, Mexico: Servicio Geológico Mexicano.
- Servicio Geológico Mexicano, 2014, Carta Geológico-Minero San Tiburcio G14C82. Pachuca, Hidalgo, Mexico: Servicio Geologico Mexicano.
- SGS Minerals Services, 2009 (August), Progress Report 1, Evaluation of the Amenability of Camino Rojo Drill Hole Samples to Cyanide Leaching and Flotation Processes, Report SGS 54-08, Prepared for Canplats de México, S.A. de C.V.
- SGS Minerals Services, 2009 (August), An Investigation into the Amenability of 21 Camino Rojo Samples to Leaching and Flotation Processes, Report SGS-09-09, Progress Report 2, Prepared for Canplats de México, S.A. de C.V.
- Tristán-González, M. A.-D.-H.-H., 2009, Post-Laramide and pre-Basin and Range deformation and implications for Paleogene (55–25 Ma) volcanism in central Mexico: A geological basis for a volcano-tectonic stress model. *Tectonophysics*, 136-152.
- Ward, J.J., 2019, Groundwater Flow Modeling: Camino Rojo Mine Project, San Tiburcio, State of Zacatecas, Mexico. Prepared for Orla Mining, Ltd. by John J. Ward, CPG, Groundwater Consultant, LLC. July 2019 (v.2).
- Ward, J.J., 2020, Groundwater Flow Modeling for Unconstrained Mine Pit: Camino Rojo Mine Project, San Tiburcio, State of Zacatecas, Mexico. Prepared for Orla Mining, Ltd. by John J. Ward, CPG, Groundwater Consultant, LLC. February 2020.
- Weiss, S. I.-V.-D.-C., 2010, Geologic Setting and Polymetallic Style of Gold Mineralization, Camino Rojo Deposit, Northern Zacatecas, Mexico. *Gold and Base Metal Deposits in the Mexican Altiplano, States of Zacatecas and San Luis Potosí, Central Mexico*, Society of Economic Geologists Guidebook series, V. 40, 97-102.

28.0 DATE AND SIGNATURE PAGE

This Technical Report, entitled 'Unconstrained Feasibility Study NI 43-101 Technical Report on the Camino Rojo Gold Project Municipality of Mazapil, Zacatecas, Mexico has the following report dates:

Report Date is: 11 January 2021

Mineral Resource Estimate Effective Date is: 7 June 2019

Mineral Reserve Estimate Effective Date is: 11 January 2021

The report was prepared as per the following signed Qualified Persons' Certificates.

CERTIFICATE OF QUALIFIED PERSON

I, Carl Defilippi, RM SME, of Reno, Nevada, USA, Sr. Project Engineer at Kappes, Cassiday & Associates, as an author of this report entitled “Unconstrained Feasibility Study - NI 43-101 Technical Report on the Camino Rojo Gold Project - Municipality of Mazapil, Zacatecas, Mexico” dated January 11, 2021, prepared for Orla Mining Ltd. (the “**Issuer**”) do hereby certify that:

1. I am employed as a Sr. Project Engineer at Kappes, Cassiday & Associates, an independent metallurgical consulting firm, whose address is 7950 Security Circle, Reno, Nevada 89506.
2. This certificate applies to the technical report “Unconstrained Feasibility Study - NI 43-101 Technical Report on the Camino Rojo Gold Project - Municipality of Mazapil, Zacatecas, Mexico”, dated January 11, 2021 (the “**Technical Report**”).
3. I am a registered member with the Society of Mining, Metallurgy and Exploration (SME) since 2011 and my qualifications include experience applicable to the subject matter of the Technical Report. In particular, I am a graduate of the University of Nevada with a B.S. in Chemical Engineering (1978) and a M.S. in Metallurgical Engineer (1981). I have practiced my profession continuously since 1982. Most of my professional practice has focused on the development of gold-silver leaching projects. I have successfully managed numerous studies at all levels on various cyanidation projects.
4. I am familiar with National Instrument 43-101 – *Standards of Disclosure for Mineral Projects* (“**NI 43-101**”) and by reason of education, experience and professional registration I fulfill the requirements of a “qualified person” as defined in NI 43-101.
5. I visited the Camino Rojo property for a total of four days on January 17-18, 2019 and on 20-21 February, 2018.
6. I am responsible for Sections 1.1, 1.5, 1.9, 1.10, 1.12, 1.13, 1.14, 1.15.1, 1.15.2, 1.15.3.2, 1.15.3.4, 1.16.1, 2, 3, 12.2, 12.3, 13, 17, 18, 19, 20.1.7, 21.0, 21.1, 21.1.2, 21.1.3 through 21.1.9, 21.2, 21.2.2, 21.3, 22, 24.1, 24.2, 24.3, 25.1, 25.1.2, 25.2.3, 25.3.2, 25.3.4, 26.1, 27 and 28 of the Technical Report.
7. I am independent of the Issuer as described in section 1.5 of NI 43-101.
8. I have had no prior involvement with the property that is the subject of the Technical Report, other than as an author of the previous technical reports entitled “Feasibility Study - NI 43-101 Technical Report on the Camino Rojo Gold Project - Municipality of Mazapil, Zacatecas, Mexico”, dated June 25, 2019, “Preliminary Economic Assessment – Amended NI 43-101 Technical Report on the Camino Rojo Gold Project – Municipality of Mazapil, Zacatecas, Mexico” dated June 19, 2018 and amended March 11, 2019 and “CSA NI43-101 Technical Report on the Camino Rojo Gold Project, Municipio of Mazapil, Zacatecas, Mexico”, dated 24 January 2018.
9. I have read NI 43-101 and the Technical Report has been prepared in compliance with NI 43-101.
10. As of the effective date of the Technical Report, to the best of my knowledge, information and belief, the Technical Report contains all scientific and technical information that is required to be disclosed to make the Technical Report not misleading.

Dated this 8th day of February, 2021.

Signed "*Carl Defilippi*"

Carl Defilippi, RM SME
Sr. Project Engineer at
Kappes, Cassiday & Associates

CERTIFICATE OF QUALIFIED PERSON

I, Michael G. Hester, FAusIMM, of Tucson, Arizona, USA, Vice President and Principal Mining Engineer at Independent Mining Consultants, Inc., as an author of this report entitled “Unconstrained Feasibility Study - NI 43-101 Technical Report on the Camino Rojo Gold Project - Municipality of Mazapil, Zacatecas, Mexico” dated January 11, 2021, prepared for Orla Mining Ltd. (the “**Issuer**”) do hereby certify that:

1. I am employed as a Vice President and Principal Mining Engineer at Independent Mining Consultants, Inc., an independent mining consulting firm, whose address is 3560 East Gas Road, Tucson, Arizona, 85714, USA, phone number (520) 294-9861.
2. This certificate applies to the technical report “Unconstrained Feasibility Study - NI 43-101 Technical Report on the Camino Rojo Gold Project - Municipality of Mazapil, Zacatecas, Mexico”, dated January 11, 2021 (the “**Technical Report**”).
3. I hold the following academic qualifications:
 - B.S. (Mining Engineering) University of Arizona 1979
 - M.S. (Mining Engineering) University of Arizona 1982
4. I am a Fellow of the Australian Institute of Mining and Metallurgy (FAusIMM #221108), a professional association as defined by National Instrument 43-101 – *Standards of Disclosure for Mineral Projects* (“**NI 43-101**”). As well, I am a member in good standing of the following technical associations and societies:
 - Society for Mining, Metallurgy, and Exploration, Inc. (SME Member # 1423200)
 - Member of Resources and Reserves Committee of the Society of Mining, Metallurgy, and Exploration.
 - The Canadian Institute of Mining, Metallurgy and Petroleum (CIM Member #100809)
5. I have worked in the minerals industry as an engineer continuously since 1979, a period of 42 years. I am a founding partner, Vice President, and Principal Mining Engineer for Independent Mining Consultants, Inc., a position I have held since 1983. I have been employed as an Adjunct Lecturer at the University of Arizona (1997-1998) where I taught classes in open pit mine planning and mine economic analysis. I am also a member of the Resources and Reserves Committee of the Society of Mining, Metallurgy, and Exploration since March 2012. I was employed as a staff engineer for Pincock, Allen & Holt, Inc. from 1979 to 1983. During my career I have had extensive experience reviewing and auditing deposit sampling methods, analytical procedures, and QA/QC analysis. I also have many years of experience developing mineral resource models, developing open pit mine plans and production schedules, calculating equipment requirements for open pit mining operations, developing mine capital and operating cost estimates, performing economic analysis of mining operations and managing various preliminary economic assessments, Pre-Feasibility, and Feasibility Studies.
6. I am familiar with NI 43-101 and by reason of education, experience and professional registration I fulfill the requirements of a “qualified person” as defined in NI 43-101.
7. I visited the Camino Rojo property for two days from February 20-21, 2018.

8. I am responsible for Sections 1.6, 1.7, 1.8, 1.15.3.1, 10.1, 10.2, 10.3, 10.5.1, 10.6.1, 11.1, 11.2, 11.3.1, 11.3.2, 11.4.1, 12.1.1, 12.1.3, 14, 15, 16, 21.1.1, 21.2.1, 24.5, 25.1.1, 25.2.1, 25.2.2 and 25.3.1 of the Technical Report
9. I am independent of the Issuer as described in section 1.5 of NI 43-101.
10. I have had no prior involvement with the property that is the subject of the Technical Report, other than as an author of the previous technical report entitled “Feasibility Study - NI 43-101 Technical Report on the Camino Rojo Gold Project - Municipality of Mazapil, Zacatecas, Mexico”, dated June 25, 2019, “Preliminary Economic Assessment – Amended NI 43-101 Technical Report on the Camino Rojo Gold Project – Municipality of Mazapil, Zacatecas, Mexico” dated June 19, 2018 and amended March 11, 2019.
11. I have read NI 43-101 and the Technical Report has been prepared in compliance with NI 43-101.
12. As of the effective date of the Technical Report, to the best of my knowledge, information and belief, the Technical Report contains all scientific and technical information that is required to be disclosed to make the Technical Report not misleading.

Dated this 8th day of February, 2021.

Signed “*Michael G. Hester*”

Michael G. Hester, FAusIMM
Vice President and Principal Mining Engineer
Independent Mining Consultants, Inc.

CERTIFICATE OF QUALIFIED PERSON

I, Dr. Matthew Gray, Ph.D., C.P.G. #10688, of Rio Rico, Arizona, USA, Geologist at Resource Geosciences Incorporated, as an author of this report entitled “Unconstrained Feasibility Study - NI 43-101 Technical Report on the Camino Rojo Gold Project - Municipality of Mazapil, Zacatecas, Mexico” dated January 11, 2021, prepared for Orla Mining Ltd. (the “**Issuer**”) do hereby certify that:

1. I am employed as a geologist at Resource Geosciences Incorporated, an independent consulting geosciences firm, whose address is 765A Dorotea Ct, Rio Rico, Arizona, 85648 USA.
2. This certificate applies to the technical report “Unconstrained Feasibility Study - NI 43-101 Technical Report on the Camino Rojo Gold Project - Municipality of Mazapil, Zacatecas, Mexico”, dated January 11, 2021 (the “**Technical Report**”).
3. I am a Certified Professional Geologist (#10688) with the American Institute of Professional Geologists since 2003, a Member and Fellow of the Society of Economic Geologists since 1987, and my qualifications include experience applicable to the subject matter of the Technical Report. In particular, I am a graduate of the Colorado School of Mines (Ph.D., Geology with Minor in Mineral Economics, 1994; B.Sc., Geological Engineering, 1985) and the University of Arizona (M.Sc., Geosciences, 1988) and I have practiced my profession continuously since 1988. Most of my professional practice has focused on exploration for metallic mineral deposits, the creation of resource models, and the economic development of gold and copper deposits. I successfully managed mine permitting, water rights, and community relocation issues related to development of the Piedras Verdes copper mine, a large scale open pit mine in Sonora, Mexico.
4. I am familiar with National Instrument 43-101 – *Standards of Disclosure for Mineral Projects* (“**NI 43-101**”) and by reason of education, experience and professional registration I fulfill the requirements of a “qualified person” as defined in NI 43-101.
5. I visited the Camino Rojo property for a total of 21 days during the periods 12-13 December 2016, 19 to 22 February, 18 to 20 July, and 20 to 24 August 2018, and 17 to 18 January and 8 to 12 April 2019.
6. I am responsible for Sections 1.2, 1.3, 1.4, 1.11, 1.15.3.3, 1.16.2, 4, 5, 6, 7, 8, 9, 10.4, 10.5.2, 10.6.2, 11.3.3, 11.4.2, 12.1.2, 20 exclusive of 20.1.7, 23, 25.1.3, 25.2.4, 25.3.3, and 26.2 of the Technical Report.
7. I am independent of the Issuer as described in section 1.5 of NI 43-101.
8. I have had no prior involvement with the property that is the subject of the Technical Report, other than as an author of the previous technical reports entitled “Feasibility Study - NI 43-101 Technical Report on the Camino Rojo Gold Project - Municipality of Mazapil, Zacatecas, Mexico”, dated June 25, 2019, “Preliminary Economic Assessment – Amended NI 43-101 Technical Report on the Camino Rojo Gold Project – Municipality of Mazapil, Zacatecas, Mexico” dated June 19, 2018 and amended March 11, 2019, and “CSA NI43-101 Technical Report on the Camino Rojo Gold Project, Municipio of Mazapil, Zacatecas, Mexico”, dated 24 January 2018.
9. I have read NI 43-101 and the Technical Report has been prepared in compliance with NI 43-101.

10. As of the effective date of the Technical Report, to the best of my knowledge, information and belief, the Technical Report contains all scientific and technical information that is required to be disclosed to make the Technical Report not misleading.

Dated this 8th day of February, 2021.

Signed/Sealed "*Dr. Matthew Gray*"

Dr. Matthew Gray, Ph.D., C.P.G. #10688

Geologist

Resource Geosciences Incorporated

CERTIFICATE OF QUALIFIED PERSON

I, John J. Ward, C.P.G., of Tucson, Arizona, USA, Owner and Principal Hydrogeologist of John Ward, RG, Groundwater Consultant, LLC, as an author of this report entitled “*Unconstrained Feasibility Study, NI 43-101 Technical Report on the Camino Rojo Gold Project, Municipality of Mazapil, Zacatecas, Mexico*” dated January 11, 2021, and prepared for Orla Mining Ltd. (the “**Issuer**”) do hereby certify that:

1. I am Owner and Principal Hydrogeologist of John Ward, RG, Groundwater Consultant, LLC, a groundwater consulting firm, located at 10564 East George Brookbank Place, Tucson, Arizona 85747, USA.
2. This certificate applies to the technical report “*Unconstrained Feasibility Study, NI 43-101 Technical Report on the Camino Rojo Gold Project, Municipality of Mazapil, Zacatecas, Mexico*”, dated January 11, 2021 (the “**Technical Report**”).
3. I am a hydrogeologist by education, professional experience, and certification. I have a Bachelor of Science degree (1976) and Master of Science degree (1980) from the College of Earth Sciences at The University of Arizona. I have the following professional registrations and certifications: Certified Professional Geologist (#6729) with the American Institute of Professional Geologists (AIPG) since 1984; Registered Geologist in Arizona (#18435) since 1985; Registered Geologist in California (#4101) since 1986; Certified Hydrogeologist in California (#149) since 1995. My registrations and certifications are in good standing with AIPG and the state licensing boards and all are active as of the date of this certification.

I have practiced my profession as a hydrogeologist since 1980. I have managed mine and construction dewatering projects and developed groundwater dewatering models for projects in Florida, Hawaii, California, New Mexico, Arizona, and Wyoming. I have also consulted and managed, as principal investigator or professional in charge, numerous groundwater development and remedial projects.

4. I am familiar with National Instrument 43-101 – *Standards of Disclosure for Mineral Projects* (“**NI 43-101**”) and by reason of education, experience and professional registration I fulfill the requirements of a “qualified person” as defined in NI 43-101
5. I visited the Camino Rojo property for 4 days between November 13 and 17, 2018, for the purpose of inspecting the site, examining subsurface coring, conducting a well inventory of the property and surrounding region, and finalizing work plans for testing and numerical modeling.
6. I am responsible for Sections 1.16.3, 24.4, and 26.3 of this Technical Report.
7. I am independent of the Issuer as defined in Section 1.5 of NI 43-101.
8. I have had no prior involvement with the property that is the subject of the Technical Report, other than as an author or contributor to previous Camino Rojo technical reports for Orla Mining Ltd., including:

FEASIBILITY STUDY
NI 43-101 Technical Report on the Camino Rojo Gold Project
Municipality of Mazapil, Zacatecas, Mexico
June 25, 2019

MANIFESTACIÓN DE IMPACTO AMBIENTAL MODALIDAD REGIONAL
Resumen Ejecutivo
Proyecto “Camino Rojo”
Municipio De Mazapil, Zacatecas
Julio, 2019

GROUNDWATER FLOW MODELING FOR CAMINO ROJO MINE PROJECT
SAN TIBURCIO, STATE OF ZACATECAS, MEXICO
July 12, 2019; July 30, 2019 (v.2)

SUPPLEMENTAL REPORT: GROUNDWATER FLOW MODELING
FOR CAMINO ROJO MINE PROJECT
SAN TIBURCIO, STATE OF ZACATECAS, MEXICO
July 23, 2019

9. I have read NI 43-101 and the Technical Report has been prepared in compliance with NI 43-101.
10. As of the effective date of the Technical Report, to the best of my knowledge, information and belief, the Technical Report contains all scientific and technical information that is required to be disclosed to make the Technical Report not misleading

Dated this 8th day of February, 2021.

Signed/Sealed “*John J. Ward*”

John J. Ward, RG, CPG #6729
Owner and Principal Hydrogeologist
John Ward, RG, Groundwater Consultant,
LLC.